

RADAR AIDS TO NAVIGATION

Edited by

JOHN S. HALL, Ph.D.

ASSOCIATE PROFESSOR OF ASTRONOMY AND PHYSICS
AMHERST COLLEGE

OFFICE OF SCIENTIFIC RESEARCH AND DEVELOPMENT
NATIONAL DEFENSE RESEARCH COMMITTEE

FIRST EDITION



NEW YORK AND LONDON
MCGRAW-HILL BOOK COMPANY, INC.

1947

MASSACHUSETTS INSTITUTE OF TECHNOLOGY
RADIATION LABORATORY SERIES

Board of Editors

LOUIS N. RIDENOUR, *Editor-in-Chief*

GEORGE B. COLLINS, *Deputy Editor-in-Chief*

BRITTON CHANCE, S. A. GOUDSMIT, R. G. HERB, HUBERT M. JAMES, JULIAN K. KNIPP,
JAMES L. LAWSON, LEON B. LINFORD, CAROL G. MONTGOMERY, C. NEWTON, ALBERT
M. STONE, LOUIS A. TURNER, GEORGE E. VALLEY, JR., HERBERT H. WHEATON

1. RADAR SYSTEM ENGINEERING—*Ridenour*
2. RADAR AIDS TO NAVIGATION—*Hall*
3. RADAR BEACONS—*Roberts*
4. LORAN—*Pierce, McKenzie, and Woodward*
5. PULSE GENERATORS—*Glasoe and Lebacqz*
6. MICROWAVE MAGNETRONS—*Collins*
7. KLYSTRONS AND MICROWAVE TRIODES—*Hamilton, Knipp, and Kuper*
8. PRINCIPLES OF MICROWAVE CIRCUITS—*Montgomery, Dicke, and Purcell*
9. MICROWAVE TRANSMISSION CIRCUITS—*Ragan*
10. WAVEGUIDE HANDBOOK—*Marcuvitz*
11. TECHNIQUE OF MICROWAVE MEASUREMENTS—*Montgomery*
12. MICROWAVE ANTENNA THEORY AND DESIGN—*Silver*
13. PROPAGATION OF SHORT RADIO WAVES—*Kerr*
14. MICROWAVE DUPLEXERS—*Smullin and Montgomery*
15. CRYSTAL RECTIFIERS—*Torrey and Whitmer*
16. MICROWAVE MIXERS—*Pouna*
17. COMPONENTS HANDBOOK—*Blackburn*
18. VACUUM TUBE AMPLIFIERS—*Valley and Wallman*
19. WAVEFORMS—*Chance, Hughes, MacNichol, Sayre, and Williams*
20. ELECTRONIC TIME MEASUREMENTS—*Chance, Hulsizer, MacNichol,
and Williams*
21. ELECTRONIC INSTRUMENTS—*Greenwood, Holdam, and MacRae*
22. CATHODE RAY TUBE DISPLAYS—*Soller, Starr, and Valley*
23. MICROWAVE RECEIVERS—*Van Voorhis*
24. THRESHOLD SIGNALS—*Lawson and Uhlenbeck*
25. THEORY OF SERVOMECHANISMS—*James, Nichols, and Phillips*
26. RADAR SCANNERS AND RADOMES—*Cady, Karelitz, and Turner*
27. COMPUTING MECHANISMS AND LINKAGES—*Svoboda*
28. INDEX—*Henney*

TK 6573

M 41

V. 2

C 3

RADAR AIDS TO NAVIGATION

COPYRIGHT, 1947, BY THE
MCGRAW-HILL BOOK COMPANY, INC.

PRINTED IN THE UNITED STATES OF AMERICA

*All rights reserved. This book, or
parts thereof, may not be reproduced
in any form without permission of
the publishers.*

RADAR AIDS SCIENCE LIBRARY TO NAVIGATION

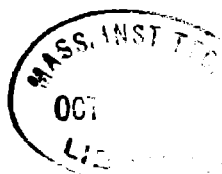

Edited by

JOHN S. HALL, PH.D.

ASSOCIATE PROFESSOR OF ASTRONOMY AND PHYSICS
AMHERST COLLEGE

OFFICE OF SCIENTIFIC RESEARCH AND DEVELOPMENT
NATIONAL DEFENSE RESEARCH COMMITTEE

FIRST EDITION



NEW YORK AND LONDON
MCGRAW-HILL BOOK COMPANY, INC.

1947



5.00

Foreword

THE tremendous research and development effort that went into the development of radar and related techniques during World War II resulted not only in hundreds of radar sets for military (and some for possible peacetime) use but also in a great body of information and new techniques in the electronics and high-frequency fields. Because this basic material may be of great value to science and engineering, it seemed most important to publish it as soon as security permitted.

The Radiation Laboratory of MIT, which operated under the supervision of the National Defense Research Committee, undertook the great task of preparing these volumes. The work described herein, however, is the collective result of work done at many laboratories, Army, Navy, university, and industrial, both in this country and in England, Canada, and other Dominions.

The Radiation Laboratory, once its proposals were approved and finances provided by the Office of Scientific Research and Development, chose Louis N. Ridenour as Editor-in-Chief to lead and direct the entire project. An editorial staff was then selected of those best qualified for this type of task. Finally the authors for the various volumes or chapters or sections were chosen from among those experts who were intimately familiar with the various fields, and who were able and willing to write the summaries of them. This entire staff agreed to remain at work at MIT for six months or more after the work of the Radiation Laboratory was complete. These volumes stand as a monument to this group.

These volumes serve as a memorial to the unnamed hundreds and thousands of other scientists, engineers, and others who actually carried on the research, development, and engineering work the results of which are herein described. There were so many involved in this work and they worked so closely together even though often in widely separated laboratories that it is impossible to name or even to know those who contributed to a particular idea or development. Only certain ones who wrote reports or articles have even been mentioned. But to all those who contributed in any way to this great cooperative development enterprise, both in this country and in England, these volumes are dedicated.

L. A. DuBRIDGE

Ridenour, L. N.

1964

RADAR AIDS TO NAVIGATION

EDITORIAL STAFF

L. A. TURNER, TECH. ED.

J. S. HALL, ED.

R. M. WHITMER, ASS'T. ED.

CONTRIBUTING AUTHORS

H. B. ABAJIAN	D. B. McLAUGHLIN
F. R. BANKS, JR.	R. E. MEAGHER
J. H. BUCK	E. E. MILLER
W. M. CADY	R. H. MÜLLER
M. A. CHAFFEE	J. P. NASH
G. C. COMSTOCK	C. F. J. OVERHAGE
D. DAVIDSON	J. A. PIERCE
R. M. EMBERSON	J. B. PLATT
A. G. EMSLIE	R. M. ROBERTSON
H. FAHNESTOCK, JR.	E. L. SINSHEIMER
G. A. GARRETT	C. A. SMITH
D. L. HAGLER	H. P. STABLER
J. S. HALL	J. M. STURTEVANT
D. HALLIDAY	W. J. TULL
J. J. HIBBERT	L. A. TURNER
N. W. MacLEAN	T. H. WATERMAN
R. M. WHITMER	

Preface

Radar Aids to Navigation is intended primarily to describe the advantages and limitations of radar equipment when applied to problems of navigation and pilotage, whether the equipment is airborne, shipborne, or ground-based. Radar beacons as aids to navigation are also discussed.

While the development of radar was proceeding apace under the impetus of the Second World War, the development of a host of nonradar navigational aids was also accelerated. These aids include systems that measure range differences like Loran and Gee and a number of azimuthal systems like the German Sonne. Descriptions of these and other nonradar aids are included to give the reader a more comprehensive picture of available techniques.

The authors have not always found it possible to present this information in a nontechnical form. The reader with no technical background should obtain a fair estimate of the value of radar in navigational problems from Chaps. 2, 3, 8, and 9. Radar indicators are described in some detail in this volume because, of all the components, they are of greatest interest to the navigator. A more detailed discussion of many of the engineering problems mentioned here is given in *Radar System Engineering*, Vol. 1 of this series.

In this volume, the emphasis is placed more on what can now be done with radar than on what should be possible in the future. A possible exception to this policy is the inclusion of several photographs of airborne radar indicators attached to radars with antenna beams 0.8° wide. Although these pictures illustrate what can now be done, beamwidths of 3° to 5° , rather than 0.8° , appear practical for airborne radars to be used as navigational aids in the near future. More emphasis has been placed on airborne radar used with beacons as an anticollision device on overwater flights simply because it does not appear reasonable to require that all airplanes flying over land have beacons.

A real effort has been made to define terms either explicitly or by their use. A certain amount of repetition results from this policy. For most radar applications described here, narrow antenna beams necessitating short wavelengths, or *microwaves*, are commonly prescribed. By

PREFACE

this term is meant radio waves between 1 and 12 cm long. It is not our intention to insult the reader's intelligence by defining words found in a small dictionary, nor even the word radar. There is no glossary. The definitions of many words may be found by reference to the index.

Thirty-three authors and many persons serving in other capacities have contributed to this book. Unfortunately it is not practical to give full acknowledgement to everyone. R. A. Whitmer, assistant editor, did a large share of the editorial work connected with the portion of the book devoted to airborne radar. L. A. Turner, technical editor, was a most constructive influence in clarifying many sections. His criticisms and suggestions were invariably followed. R. G. Herb served as technical editor during the formative stage of this project.

David Davidson deserves a solid vote of thanks for selecting the illustrations used in the sections on Loran and other navigational nets and for writing their captions. We are grateful also to M. G. White, D. T. Griggs, and R. J. Dippy for their criticism. We regretted to learn that illness prevented Dippy, the originator of Gee, from sending us a description of the miniature system similar to Gee that the British have recently used successfully as an airport approach system. Thanks are due to L. J. Laslett, R. M. Emberson, G. C. Comstock, M. A. Chaffee, and J. H. Buck for assistance in making the original outlines of the book. We are grateful to Beka Doherty who, as an uninhibited reader, read the final manuscript and made many helpful criticisms and suggestions.

We acknowledge with thanks the careful manner in which Louise Butler, our production assistant, guided the diagrams and photographs to their ultimate completion. A large amount of secretarial work connected with the book was cheerfully done by Bernyce Goldberg. Thanks are due to Eleanor Uhl who acted as editorial assistant during the formative stages of the book and particularly to Barbara Rudolph who bravely shouldered this responsibility during its critical final stages.

JOHN S. HALL.

CAMBRIDGE, MASS.,
June, 1946.

Contents

FOREWORD BY L. A. DuBRIDGE	vii
PREFACE	ix

PART I. INTRODUCTION

CHAP. 1. PRINCIPLES OF RADAR	3
HOW RADAR WORKS	3
1-1. The Fundamental Ideas	3
1-2. Resolution, Accuracy, and Coverage	10
1-3. Design Considerations	15
PROPAGATION	21
1-4. Curvature of the Earth and Atmospheric Refraction	21
1-5. Atmospheric Attenuation	22
INDICATORS	26
1-6. Cathode-ray Tubes	26
1-7. Synchros, Servomechanisms, and Amplidynes	28
1-8. Different Types of Indicators	30
RADAR BEACONS	36
1-9. Operation	36
1-10. Future Developments; Systems	41
CHAP. 2. NONRADAR NAVIGATIONAL METHODS	44
2-1. Nonradar Navigational Methods	44
2-2. Radio Ranges	44
2-3. German Radio Range, Sonne	47
2-4. Ultra-high-frequency, Navigational Aids, uhf	50
2-5. Airborne and Shipborne Direction Finders	51
2-6. Ground Direction Finders	54
2-7. Celestial Navigation	55
LORAN AND OTHER NAVIGATIONAL NETS	56
2-8. Hyperbolic Systems	56
2-9. Gee	60
2-10. Loran	64
2-11. "SS" Loran	70
2-12. Low-frequency Loran	72
2-13. Decca	76

CONTENTS

2-14. Accuracy and Range of Various Hyperbolic Systems	77
2-15. Automatic Data Analysis	79
2-16. Automatic Piloting	82

PART II. AIRBORNE RADAR

CHAP. 3. CHARACTERISTICS OF AIRBORNE RADAR.	89
INTRODUCTION	89
3-1. Features Revealed by Radar Mapping.	89
3-2. Details in Radar Mapping.	96
3-3. The Operator.	105
3-4. Measurement of Drift and Ground Speed	105
3-5. Determination of Drift and "Ground Speed" Over Water	110
3-6. Information Available on Flights Over Water.	112
3-7. The Use of Maps as Aids to Radar Pilotage	115
3-8. Radar Beacon Navigation	117
CHAP. 4. SPECIAL AIDS AND DEVICES.	122
NAVIGATION AND ANTICOLLISION	122
4-1. The Ground Position Indicator.	122
4-2. Anticollision Radar Devices	128
ALTITUDE DETERMINATION.	131
4-3. Pulsed Radio Altimeters (SCR-718C)	132
4-4. Frequency-modulated Altimeters (AN/APN-1).	136
4-5. Comparison of F-m and Pulsed Altimeters.	141
4-6. Suggested Future Trends.	142
CHAP. 5. SPECIAL DESIGN CONSIDERATIONS.	143
5-1. Receivers	143
5-2. Indicators	148
5-3. Antennas	155
5-4. Antenna Stabilization	156
CHAP. 6. ENGINEERING AND ECONOMIC CONSIDERATIONS.	161
6-1. Installation.	161
6-2. General Design Considerations	165
6-3. Performance of AN/APS-10	171
6-4. Characteristics of the AN/APS-10 Radar: I	174
6-5. Characteristics of the AN/APS-10 Radar: II.	181
6-6. Typical Performance of Some Existing Systems.	185
6-7. Economic Aspects of Airborne Radar	187

PART III. GROUND-BASED RADAR

CHAP. 7. TYPES OF GROUND-BASED RADAR AND SPECIAL EQUIP- MENT.	193
SEARCH AND AUTOMATIC-TRACKING RADARS.	193
7-1. A Long-range Microwave System.	193
7-2. Automatic Tracking Systems.	202

CONTENTS

HEIGHT FINDERS	207
7-3. Height-finding Methods	207
7-4. General Problems of Design	212
7-5. Illustrations of Some Recent Systems	218
RADAR AIDS FOR LANDING	227
7-6. Beam Approach Systems	227
7-7. Beacon Approach Systems, BABS	232
7-8. Ground-based Scanning Radar Systems	237
SPECIAL RADAR AIDS	252
7-9. Moving Target Indication	252
7-10. Beacons	256
7-11. Radar Relay	258
7-12. Video Mapping	267
7-13. Radar Aids to Mapping	278
CHAP. 8. RADAR AIDS TO AIR NAVIGATION AND TRAFFIC CONTROL	285
8-1. Statement of the Problem	285
8-2. Navigation and Traffic Control Using Airborne Radar Aids	293
8-3. Navigation and Traffic Control Using Ground-based Radar Aids	299
8-4. Summary of Proposed Aids	311
PART IV. SHIPBORNE RADAR	
CHAP. 9. NAVIGATION AND PILOTAGE	317
9-1. How Radar Can Help the Navigator	317
9-2. Coordination of Radar Data with Other Data	320
9-3. Marine Radar Beacons	322
9-4. Corner Reflectors	324
9-5. Principle of Superposition Navigation	331
9-6. Chart-matching Equipment	335
9-7. Accuracy Obtainable by Chart Matching	344
9-8. PPI Simulations	351
BIBLIOGRAPHY	353
CHAP. 10. A SHIPBORNE NAVIGATIONAL RADAR	354
10-1. Radar Propagation over Water	354
10-2. General Specifications of a Shipborne Navigational Radar	363
10-3. Antenna Assembly	364
10-4. Transmitter-receiver Package	371
10-5. Indicator	373
10-6. Power Supply	377
10-7. Physical Characteristics of the Components and Test Equipment	379
INDEX	383



PART I
INTRODUCTION



CHAPTER 1

PRINCIPLES OF RADAR

BY J. S. HALL, J. P. NASH, D. HALLIDAY, R. M. WHITMER,
R. E. MEAGHER, AND J. B. PLATT

Before we discuss how radar can help us solve problems in navigation, we should first describe how radar works. This chapter gives the common background of knowledge needed for use in the three main divisions of this book, airborne radar, ground-based radar, and shipborne radar.

HOW RADAR WORKS

BY J. S. HALL

1.1. The Fundamental Ideas.—There are a number of situations where men or animals cannot see clearly but succeed, nevertheless, in finding their way about. They do this by making sounds and then detecting echoes from solid objects still some distance away. The echoes are used as guides. Many blind persons, for instance, develop in the course of time a considerable ability to avoid obstacles by means of auditory cues received from sounds of their own making, like footsteps or the tapping of a cane. Their skill is often drastically impaired if their hearing is blocked by ear plugs or by distracting noises. Bats can fly through the total darkness of caves without striking the walls or jutting stalactites which may be in their way. This is possible because they emit a supersonic cry—in audible to human ears because its frequency is from 30,000 to 70,000 cps—and orient themselves by means of the echoes of this cry, which return to them from any obstacles which lie ahead.¹

The experimental evidence² which forms the basis of these conclusions makes fascinating reading. It has been demonstrated conclusively that a bat loses his uncanny ability to navigate in the dark if his mouth is tied shut or his hearing impaired. The rate at which he produces supersonic cries has been shown to increase according to a definite pattern (always to the advantage of the bat) as he approaches obstacles in his path. These facts, combined with the special anatomical character-

¹ D. R. Griffin, *Science*, **100**, 589-590 (1944).

² D. R. Griffin and R. Galambos, *Jour. Exp. Zool.*, **86**, 481-505 (1941).

istics of their larynges and ears, indicate strongly that bats use the general principle of radar as an aid to navigation.

A man standing in a dory on a quiet foggy day at sea vainly tries to see a cliff which he believes to be about a mile ahead. He points a megaphone toward the cliff and shouts through it once, noting the reading of the second hand of his watch as he does so. Then he quickly puts the mouthpiece to his ear and observes the instant at which he hears the echo of his shout. Because this boatman knows that sound travels at approximately 1000 ft/sec, he reasons that if the interval between shout and echo is 10 sec, the sound has traveled a total distance of 10,000

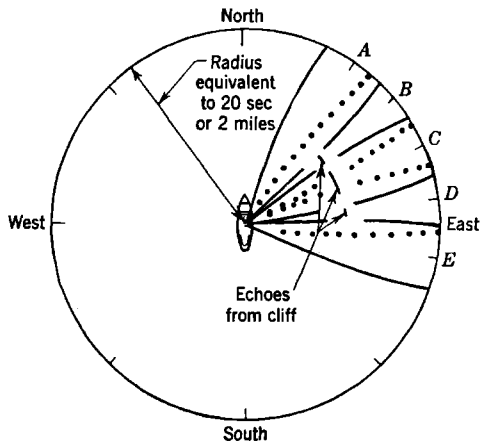

FIG. 1-1.—A sonic analogy to radar. A boatman, in search of a cliff, shouts successively in directions A, B, C, D, and E. He hears the loudest echo in direction C. Since, if the cliff were about a mile away, the echo requires about 10 sec to make the round trip, it is plotted as shown.

ft. which tells him that the cliff is 5000 ft. away. Now if he repeats this procedure with the megaphone pointing in different directions, and observes the direction of loudest response, he can determine the relative bearing as well as the range of the cliff. This information can be plotted, as shown in Fig. 1-1.

A radar set operates in a closely analogous way. Instead of using shouts and sound waves, however, it uses short pulses of electromagnetic energy transmitted as very-high-frequency radio waves. A most difficult thing for laymen to understand is the extremely short time scale that must be used. Radar pulses travel with the velocity of light, which in air under standard atmospheric conditions is 186,218 statute miles per sec. Thus, if the boatman used a radar set to locate the cliff, the echo would return only 10.2 microseconds (μ sec or millionths of a second) after

the pulse was transmitted. This is about *one millionth* of the time required for sound to travel the same distance.

Such short time intervals must be measured by electronic methods. As each pulse is transmitted, a small spot starts to move at a uniform speed radially outward from the center of the face of a cathode-ray tube. If no echo were received, that is, if the radar pulse did not bounce back from an object in its path, it would trace a faint line of uniform intensity on the face of the tube. But if an echo is received—if the radar pulse does bounce back from an object—it intensifies this spot and brightens momentarily a short segment of the line. If several hundred pulses per second are transmitted, and this process is repeated for each pulse, the echoes from these pulses repeatedly brighten the same segment on the face of the cathode-ray tube, making a steady spot of light.

The antenna which radiates the pulses directs the electromagnetic energy into a narrow beam, like that of a searchlight. If this antenna is rotated slowly in azimuth, and if the direction the radial line makes on the tube face is rotated in synchronism with it, the position of the spot of light on the tube face will show both the direction and range of the object the radar set is looking for—in this case, the cliff.

The problem of locating an object with radar, then, is a dual one. The time it takes each pulse to reach an object and return must be measured accurately. An indication of the direction in which each pulse is propagated must be presented simultaneously in an easily understandable form. Ways in which such information is obtained are discussed in later sections. The most widely used way in which this information is presented is the plan position indicator, or PPI, which is described below.

Measurement of Range.—Let us first discuss what happens in the various components of a radar set during the lifetime of a single pulse. It is suggested that the reader refer occasionally to Fig. 1-2 as he reads this discussion. We shall simplify the situation by assuming that the antenna, and therefore the indicator trace, are fixed in direction.

A radar is dormant until an electrical signal, called a "trigger," is developed by the synchronizer which may be thought of as the timer or radar clock. The trigger goes into the modulator and indicator at the same instant. The modulator transforms the trigger into a rectangular voltage pulse of extremely short duration—usually no more than 1 μ sec—which has a peak value of somewhere between 10 and 25 kv (kilovolts). The high-voltage pulse goes to the transmitter, which converts it into high-frequency electromagnetic energy. This energy is made to flow through a piece of hollow rectangular tubing, or waveguide, to the antenna. The antenna then radiates it into space in the form of a beam.

All this can happen in less than $1 \mu\text{sec}$ because electrical energy travels along conductors with a speed only slightly less than that of light *in vacuo*.¹ This slug of electromagnetic energy radiated by the antenna for a period of $1 \mu\text{sec}$ contains a large number of waves whose lengths

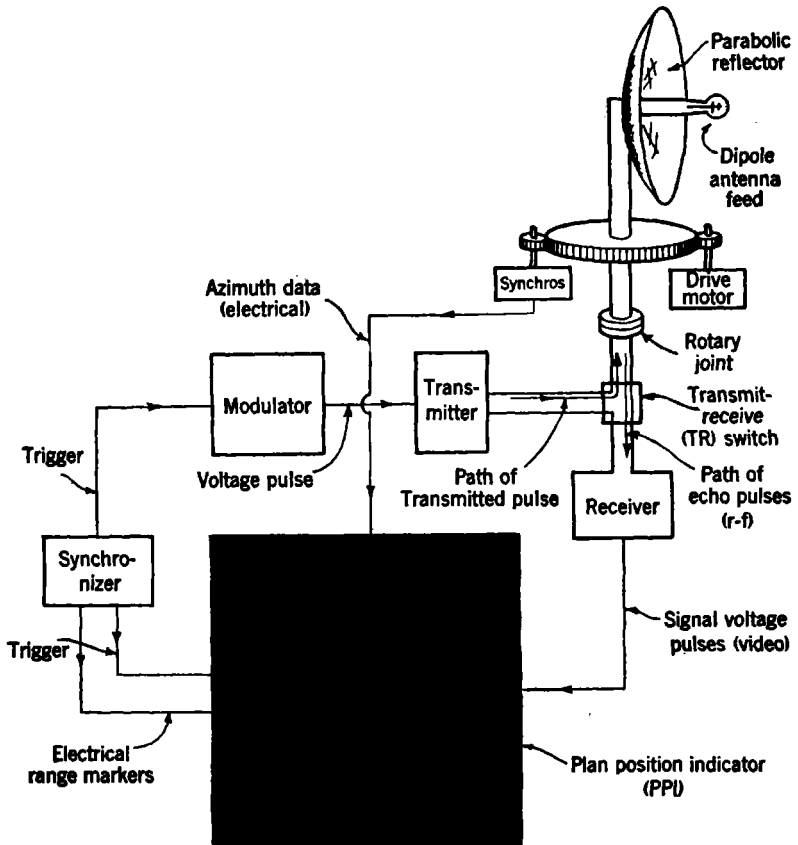

FIG. 1-2.—Radar block diagram showing the components packaged in a common form.

are very short, compared to ordinary radio waves. For a $1\text{-}\mu\text{sec}$ pulse, the distance between the leading and trailing edges of this wavetrain in empty space is 984 ft.

¹ A very special switching arrangement allows the transmitted pulse to pass through the waveguide to the antenna at high power levels, while, at the same time, it prevents all but a very small portion of the pulse from leaking into the receiver. Then, in a matter of 1 or $2 \mu\text{sec}$, the switch disconnects the antenna from the transmitter and reconnects it to the receiver.

After the energy has been transmitted, extremely small portions of it are reflected back toward the antenna by a great variety of objects. Successive echoes strike the antenna and are then fed back through the waveguide to the receiver. The receiver performs the reverse function of the transmitter, but at very low energy levels; that is, it transforms the extremely weak pulses of high-frequency electromagnetic waves reflected from the various targets within the antenna beam back into voltage pulses. In doing so, it amplifies them many times before passing them on to the indicator, as so-called "video" signals, at a voltage level of a few volts.¹

The reader will recall that as the trigger goes to the modulator it simultaneously goes to the indicator. In the indicator, the trigger causes a beam of electrons to strike from behind the center of a luminescent screen which backs the face of a large cathode-ray tube. If this beam were stationary, the observer would see a bright spot. As a pulse of electromagnetic energy goes out from the antenna, this beam of electrons moves radially at a constant speed toward the edge of the tube and a faint line is generated on the luminescent screen. This process is illustrated in Fig. 1-3.

The intensity of this beam of electrons is increased considerably and the line brightened momentarily whenever signals are received. The observer, therefore, sees a series of brightened spots on this line. The distance of any one of these spots from the center of the tube is a measure of the time it took the radio waves to travel to the various targets and back. Since it requires 10.7 μ sec for a pulse to reach a target a mile away and return from it, it is evident that the time required by a pulse to reach any target and return divided by 10.7 gives the range to the target in statute miles.

It is important to note that as each radar pulse is generated, a single trace (hereafter called a "sweep") is drawn across the face of the indicator tube by the beam of electrons. The number of separable echo pulses visible on a single sweep depends upon the length of the sweep and the number of resolvable objects within range of the radar system. If this range were 20 statute miles, for instance, the signal from an object at this distance would appear 20 times 10.7, or 214 μ sec, after the start of the sweep. And if the sweep length were 20 miles, such a signal would occur at its very end, while another signal in the same direction at only 10 miles would appear on the same trace only half way to the end. Since our pulse is 1 μ sec long, the length of such a signal, if produced by a small object, would cover $\frac{1}{214}$ of the radius of the tube. Actually, for

¹ There is an upper voltage limit placed on the return from strong signals in order to limit the light intensity on the tube to a reasonable value with respect to weaker echoes.

this sweep length it may be somewhat longer because the signal cannot be smaller than the inherent diameter of the luminescent spot.

Let us now examine what happens when a sequence of regularly spaced pulses is transmitted. It is evident that after the beam has swept across the tube, further signals which were produced by one transmitter pulse cannot be observed. After a lapse of, say, 100 μ sec to permit the sweep circuits of the indicator to recover, the radar is ready

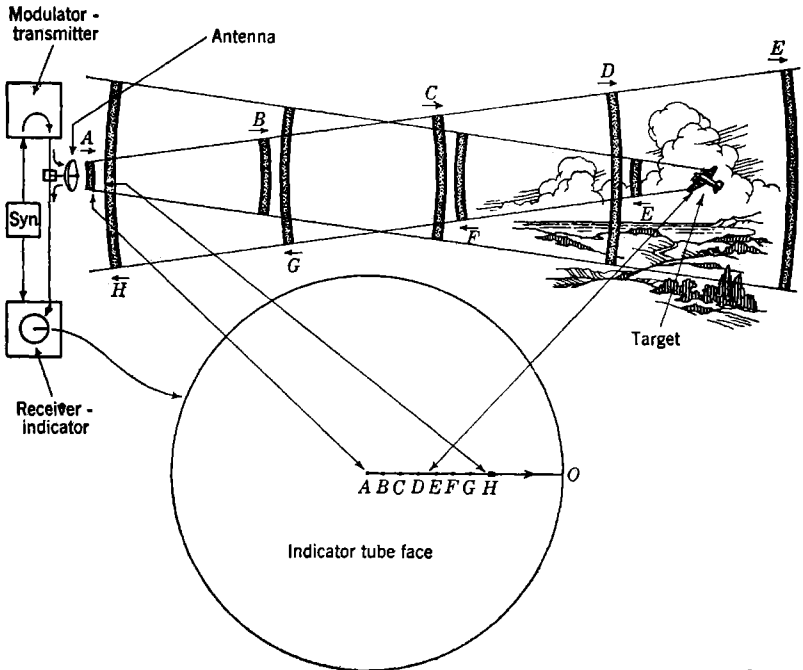

FIG. 1-3.—The life of a single pulse. The letters denoting the position of the pulse in space are also used to show the corresponding positions of the electron beam as it sweeps across the face of the indicator tube from A to O. The observer would see the signal at H only.

to send the next pulse. The signals appear at the same positions on the PPI as each successive pulse is transmitted. In fact, if the sweep length were 20 miles, this process could be repeated 3000 times per second. Since the eye cannot perceive flutter due to successive sweeps if such sweeps recur oftener than about 30 per sec at low light intensities, a steady string of signals would appear as bright beads superimposed on the sweep line.

We have seen how the observer is able to obtain the ranges of a sequence of targets from their positions on the PPI sweep. The way in

which he measures these positions depends on the complexity of the radar.

The simplest procedure is to place a suitably engraved transparent disk over the face of the tube. A more elaborate arrangement is one in which range markers are generated electrically at regular intervals after each transmitted pulse, the first marker always occurring simultaneously with the trigger from the synchronizer.

If now we imagine the sweep rotating in synchronism with the antenna it should be evident that these electronic markers would trace concentric circles on the face of the tube. On fast sweeps it is usually possible to estimate the range of a target with an average error of no more than $\frac{1}{8}$ mile.

Measurement of Bearing.—We will now see how signals appear when the antenna and sweeps rotate together. It is desirable first to point out certain important general features of the indicator tube itself.¹

A deflection coil is so mounted as to surround the glass neck of a cathode-ray tube. The current through this coil begins to rise as each pulse is transmitted. The current in the coil changes in such a way that the electron beam is deflected at a uniform rate from the center to the edge of the tube. *The direction taken by this sweep corresponds directly to the orientation of the coil.* Consequently, if the coil is rotated mechanically in synchronism with the antenna, each sweep would take a slightly different direction, which corresponds to that of the antenna. An electrical linkage system, known as a "servomechanism" (Sec. 1-7), is commonly used to keep the coil orientation in step with the antenna. It is customary to orient this coil in such a way that the sweep assumes the "12 o'clock" position when the antenna is pointed north and to rotate the antenna from north to east so that the sweeps rotate clockwise.

The number of pulses per second and the speed of antenna rotation are set at such rates that successive sweeps are barely resolved at the outer edge of the tube. Near the center they overlap.

As the direction of the sweeps changes around the face of the tube, bright bluish-white signals appear along each sweep. Although these signals decrease rapidly in intensity to a yellow glow, they persist long enough to produce a maplike picture of the region immediately surrounding the antenna. Individual landmarks are revealed only in their gross dimensions. As the antenna rotates, they reappear continuously at the same places on the tube face if the relative position of target and radar is fixed.

The bearing of any particular object may be determined by bisecting its signal on the tube face with a cursor (a radial line inscribed on a

¹ A more detailed description of the cathode-ray tube and various types of indicators is given toward the end of this chapter.

transparent overlay) which can be rotated manually about an axis coincident with the center of the tube face, and then reading the corresponding bearing on a circular scale at its periphery. A simpler method is to use a transparent overlay with bearing lines and figures engraved on the side next to the tube face. Angle markers can be displayed electronically by brightening a few successive sweeps at intervals of 10° or 15° .

1-2. Resolution, Accuracy, and Coverage. *Range Resolution, Minimum Range, and Range Accuracy.*—The range resolution of a radar is the minimum resolvable separation in the range of two targets. It depends on the length of the transmitted pulse, the characteristics of the receiver and indicator, and the type of target. A pulsed radar transmitter does not transmit on a single frequency, but rather on a narrow band of frequencies. The width of the band in which most of the energy is transmitted is inversely proportional to the pulse length; it is about 2 Mc (megacycles) wide for a $1 \mu\text{sec}$ pulse and 8 Mc for a $\frac{1}{4}\text{-}\mu\text{sec}$ pulse.

The intermediate-frequency amplifier of the receiver must be capable of amplifying energy distributed over this range of frequencies so that most of the detected energy can be profitably presented on the indicator. This range of frequencies—the so-called “pass band” of the receiver—must be tailored to the pulse length. If it is too wide, background effects or “noise” might drown out weak signals entirely. It is not yet practical to use pulses that are much shorter than $0.1 \mu\text{sec}$.

After the amplified signals in the receiver have been rectified into voltage pulses, they are again amplified and limited in voltage before going to the indicator. This last amplification is accomplished in a so-called “video amplifier.” Its pass band should be at least half that of the intermediate-frequency amplifier mentioned above if the full range-measuring capabilities of the radar are to be realized.

The range resolution of a particular radar system cannot be stated exactly without actual tests on different types of targets. With a well-designed radar, sharply defined targets at the same bearing should be resolved if their ranges differ by the distance light travels in a time equal to half the pulse length. Figure 1-4 shows that two targets should be resolvable with a radar generating $1\text{-}\mu\text{sec}$ pulses if the targets are separated in range by the distance light travels in $\frac{1}{2} \mu\text{sec}$, which is 492 ft. An experienced observer can sometimes resolve certain types of targets separated by less than this distance.

The minimum range at which signals can be detected depends on many factors. An experimental radar system has been made whose minimum detectable range is only a few feet; the effective minimum range for most radars is between 200 and 1000 ft. In surface-based radars it is customary to reduce the receiver sensitivity considerably (by an elec-

tronic method) at the time each pulse is generated, and then to allow the sensitivity to return gradually to the optimum value after an interval of about $50 \mu\text{sec}$. This "sensitivity time control," STC,¹ permits the observation of strong signals near-by by weakening or eliminating fainter signals which tend to clutter up the indicator.

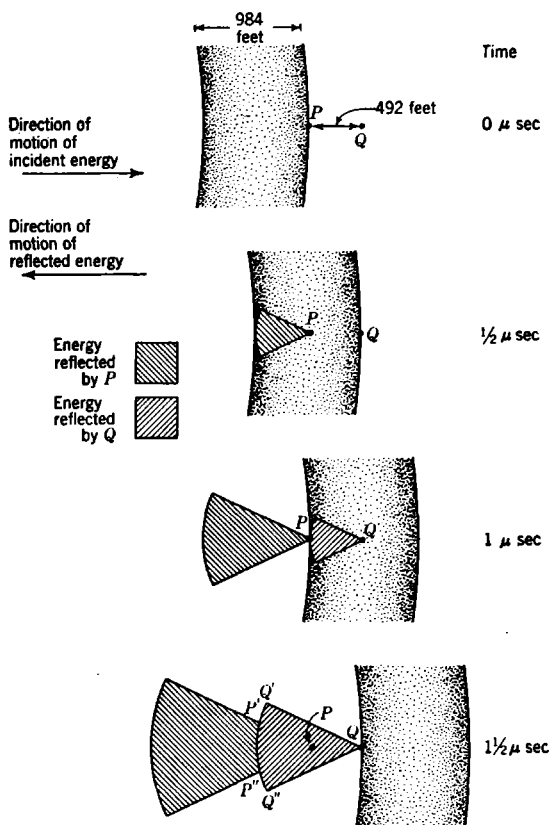

FIG. 1-4.—Two targets, P and Q , have the same radar bearing, but differ in range by the distance light travels in $0.5 \mu\text{sec}$, or by 492 ft. The four diagrams show the position of the incident and reflected energy of a 1- μsec pulse as it passes these two targets. The bottom diagram shows that the trailing edge of the pulse reflected from P , or $P'P''$, is coincident with the leading edge of the pulse reflected from Q , or $Q'Q''$. It is evident that the two targets are so separated as to be at the limit of range resolution.

Sweep speed is probably the most important single factor that governs the accuracy with which range can be measured. For most radar sets, the range of targets such as ships or airplanes can be determined from the

¹Such a control device is also known as "time-varied gain," and in Britain as "temporal gain control."

PPI tube face to within about an eighth of a mile. By projecting virtual images of maps onto the PPI (see Sec. 9-6), it is possible, with fast sweeps, to determine range with errors of 150 ft or less. Radar systems that can determine range to within 10 or 15 ft have been designed for special purposes.

Azimuth Accuracy and Resolution.—Let us assume first that it is possible to confine the radar energy into a very thin vertical sheet as it travels through space. As the antenna rotates, a small target, such as a chimney 10 miles away, is momentarily illuminated. It is evident that energy from only a few pulses is reflected back to the antenna. As a result, only a few sweeps on the PPI are brightened and the signal

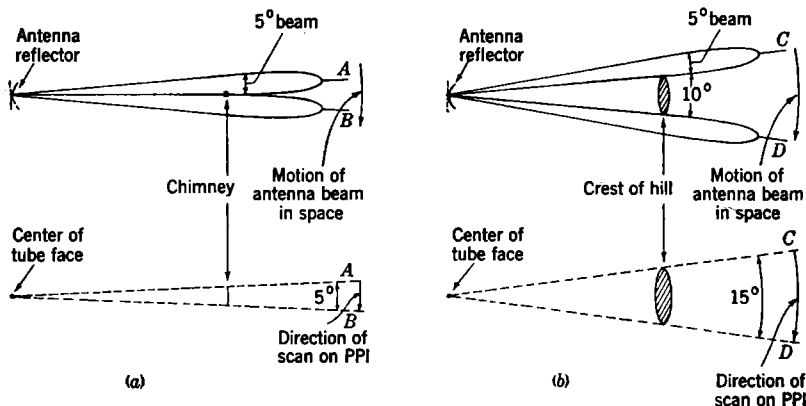

FIG. 1-5.—Relationship between width of the antenna beam and the signal produced on the PPI by (a) a point source, and (b) an extended object.

appears at the proper angle and range on the tube as either a spot or a very short arc.

Let us now assume that the effective width of the antenna beam is 5°, and see what sort of signal the chimney will produce on the PPI. Since all pulses within this 5° sector will now enhance their respective sweeps at the proper time, the signal will be an arc 5° wide, with its center lying in a direction corresponding to that of the direction of the chimney. If we go one step further and replace the chimney with the crest of a hill which subtends an angle of 10° at the antenna, the angular width of the beam has been added to the width of the hill and the resulting signal is an arc subtending a 15° angle. Both of these points are illustrated in Fig. 1-5.

Antenna beamwidth may be arbitrarily defined as the angular distance between two directions in space where the power has half the maximum value.

The angular width of the arc on the PPI also depends on factors

other than beamwidth. All antennas radiate small amounts of power in directions other than that of the main lobe. Flanking the main lobe on each side, there may be one or two so-called "side lobes" which contain less than 2 per cent of the energy in the main lobe. In some cases this is sufficient to produce from a single target two or more signals placed symmetrically on each side of the main image. A very large, distant target, such as a ship standing broadside to the radar beam, or small close targets, may even produce semi-circular arcs on the PPI.

The observer can often eliminate these effects by reducing the gain (amplification) of the radar receiver until only the signal voltage from the center of the main lobe is strong enough to show on the PPI. When this is done, however, the receiver can no longer detect very weak signals.

It has already been mentioned that sensitivity time control, STC, can automatically turn down the receiver gain for the first few miles of signals and thereby permit only the stronger ones to be resolved. For all but shipborne radars, ground signals are not only very numerous but, because they are near and therefore strong, they are usually much broader than normal and often tend to clutter up the PPI. Although STC is a helpful device, other and more effective methods of eliminating the undesirable effects of nearby signals can be used. Such methods are discussed in Secs. 5-1 and 7-9.

It is difficult to discuss azimuth resolution without again mentioning range resolution. Targets appearing at the same bearing but differing in range by 500 ft usually can be seen separately on a fast sweep when pulses of 1 μ sec or less are used. This is true regardless of whether the two targets are 6 or 60 miles away, although in the latter case the beginning of the fast sweep must be delayed. When each target can be seen separately, its arc can be bisected by the cursor and its bearing determined to about one-tenth the width of the radar beam. With our typical beamwidth of 5°, the bearing of each target can be found to 0.5°. This value corresponds to $\frac{1}{2}$ mile at 57 miles—in other words, at 57 miles the position of each target can be determined to within 500 ft in range and $\frac{1}{2}$ mile in a direction perpendicular to the line of sight. This latter uncertainty would decrease to $\frac{1}{10}$ mile (or 264 ft) at 5.7 miles. It is evident from this discussion that radar is particularly effective in range resolution.

If the two targets are at the same range, however, the story is different. Figure 1.6 shows that in order to be resolved in azimuth they would have to be separated by approximately one beamwidth. In our example, this corresponds to 5 miles at 57 miles. Unless the targets were so separated, a single long arc would appear on the PPI. An experienced observer might suspect from its unusual length that more than one target was present; the two could then be resolved by turning down the receiver gain until each signal was just visible.

It is evident, therefore, that high range resolution (short pulses and fast sweeps) will tend to compensate for the disadvantages of a wide antenna beam. This compensation is more important for surface-based radars than for airborne systems. It is also true that the antenna pattern should be made as sharp as possible in order to keep the signals small on the indicator tube. The problem of identifying landmarks, particularly with airborne sets, can in this way be made less difficult.

Relation between Beamwidth, Antenna Size, and Wavelength.—It can be shown theoretically that the beamwidth (in radians) for a circular aperture is given roughly by the expression $1.2 \lambda/D$, where λ is the wavelength employed and D is the diameter of the aperture. This expression

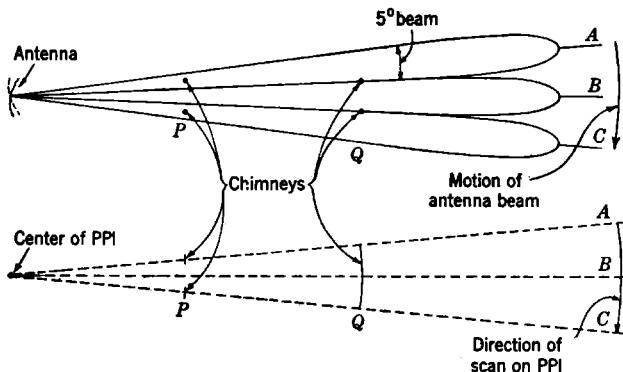

FIG. 1-6.—Relationship between the beamwidth of the antenna and azimuth resolution. The two chimneys at Q have an angular separation equal to the beamwidth and are at the limit of resolution. If the same two chimneys were at P , or at one-half the range, it is apparent that each would appear as separate signals on the PPI.

holds tolerably well for paraboloids whose boundaries are not circular but elliptical in shape.

Two widely used wavelengths¹ which are useful for navigational radars are in the 10- and 3-cm regions. Substituting in the above expression, we find that if D is measured in feet, the beamwidth in degrees at 10.7 cm is $24/D$. At 3.25 cm, it is $7.3/D$. We see from these expressions that a 6-ft circular paraboloid will form a circular beam 4° in diameter at 10.7 cm; at 3.25 cm the same paraboloid or "dish" will form a beam 1.2° in diameter. At 10.7 cm, a paraboloid 18 ft in the horizontal direction and 6 ft in the vertical produces a beam 1.3° wide and 4° high.

Coverage.—There is a large variety of antenna dishes and feeds. Because we are more concerned with principles than with applications in this section, only two commonly used antennas are described.

¹ Radars with wavelengths up to 2 meters proved extremely useful during the war and are of great historic interest. Their value is severely limited, however, because very large antennas are required to produce reasonably sharp beams.

The 18- by 6-ft dish mentioned above may be fed by a single horn at the focus of the paraboloid. A second horn can be placed below the first in such a way as to produce a similarly shaped beam parallel to the first in azimuth but above it in elevation. That is, if the beam produced by energy from the first horn went from the horizon to 4° in elevation, that produced by energy from the second horn would cover the region from 4° to 8° . A third horn could be added; the composite beam would then be 1.3° wide and 12° high. If such an antenna were to be a component of a high-power radar system designed to follow airplanes flying as high as 30,000 ft at a distance of 100 miles, the power fed into each horn would be fixed in such a way that the uppermost horn (which produces the lowest beam) has sufficient power to reach such targets at 100 miles. The geometry of the problem is such that the center horn need radiate only enough power to reach the same target at 50 miles, and the lowest horn enough to reach it at 32 miles. In other words, the amounts of energy radiated by each horn are such that the airplane, first detected 100 miles away flying at 30,000 ft, would be just visible as it approached at this altitude until it passed over the beam at an elevation of 12° and a range of 27 miles.

This type of coverage is called "cosecant-squared coverage" because the signal intensity is proportional to the square of the cosecant of the angle between the horizontal and the line to the target. It can also be obtained by the use of a single horn (or dipole feed) and by shaping the dish properly. In airborne sets, the cosecant-squared coverage is in a downward direction because it is desired to radiate less energy in the direction of the nearby ground signals. This pattern may extend from 7° to 60° below the horizontal plane. Figures 6-12 (Sec. 6-4) and 7-6 (Sec. 7-1) show examples of cosecant-squared coverage of airborne and surface-based radars.

1.3. Design Considerations. *The Range Equation.*—The range of any radar system depends upon the transmitted power, the minimum discernible power or receiver sensitivity, the antenna gain, and the effective cross section of the target. In this section, each factor is described separately, and the manner in which each affects the range of a radar system is then explained. This explanation is followed by an analysis of other factors which should be weighed before the parameters of a system designed for a specific purpose are chosen.

The symbol P_t will be used to denote the pulse power of the transmitter. A pulse power of 100 kw would mean that this amount of power was radiated by the transmitter during the very short periods of time when it is in operation. The length of a pulse is extremely short compared to the time between pulses; the main reason that such high pulse powers are possible is that the transmitter operates for such a small

fraction of the time. In some applications the value of P_t is limited by the *average* power capabilities of the transmitter tube, particularly when long pulses or high repetition rates are used in conjunction with high pulse power. A pulse power of 1 megawatt, or 1000 kw, can be maintained for periods of 1 μ sec 400 times per sec.

The minimum discernible signal S_{\min} can be defined roughly as the smallest signal power which a receiver-indicator system is able to detect and amplify in such a way that the observer can distinguish visually between it and random power fluctuations on the face of the indicator tube. Such fluctuations first appear as small spots along the sweep and are commonly described as "noise." This term stems from the fact that this phenomenon was first observed as a hissing roar in radio receivers. A good observer-receiver combination will sometimes detect a signal whose strength is a millionth of a millionth of 1 watt, or 10^{-12} watts. Since there is very little difference in complexity or cost between good and poor receivers, an effort should always be made to use the best receiver available. A competent observer is an equally good investment.

It is of interest to note that the power radiated by the antenna may exceed by a billion billion times that returned to it by a barely detectable signal.

The antenna gain G of a transmitting system represents the increase in power in a particular direction which results when the radar energy is focused by the antenna as compared with the energy which would have been transmitted in that direction if the antenna radiated equally in all directions. An object which radiates equally in all directions—the sun, for example—is called an "isotropic" radiator. The energy from a small light source can be directed into a parallel beam by placing this source at the focus of a parabolic mirror.

When a short rod (called a dipole) or a horn is placed at the focus of a searchlight type of reflector, which has an area A , and is fed by electromagnetic energy of wavelength λ , the gain is given by the expression $G = KA/\lambda^2$, where K is a factor which depends upon the type of antenna. Its value is about 5 for an antenna using a dipole or horn feed with a parabolic reflector. A horn feed consists simply of a piece of rectangular waveguide whose flared open end faces the paraboloid and is placed at its focus. If the aperture of the reflector were 3 ft and the wavelength were 3.25 cm (X-band) the gain would be close to 3100. We have seen that the resulting beamwidth would be $7.3/D$ or 2.4° between half-power points. If the aperture were doubled, the beamwidth would be halved and the gain quadrupled.

The effective cross-sectional area of the target σ is a quantity which measures the ability of a target to reflect radar signals and is a factor which the radar set designer must consider in order to make his radar capable of

detecting targets of a known cross section at a given range. The value of σ depends on the aspect, shape, size, and composition of the target. For complex targets like ships and airplanes, σ does not change rapidly with the wavelength of the incident energy when microwaves are used. It is customary to define the effective scattering cross section of a target as the cross section of a reflecting sphere which would give an echo of the same strength at the same range. Such a sphere would reflect energy isotropically.

Flat surfaces can give an intense directional reflection, as the windshield of an automobile does when it flashes in the sunlight. A complex target like an airplane may be said to reradiate the incident radar energy as a complex pattern of lobes. This pattern is analogous to a sequence of flashes that would come from different parts of an aircraft if it were maneuvering in the sunlight. Consequently, the intensity of an airplane signal fluctuates considerably as the position of these lobes changes with respect to the radar from one scan to the next. Characteristic changes in signal strength produced by the roll of a ship, the bobbing of a buoy, or the undulation of waves can often be identified readily by an experienced observer. Land signals are usually steadier, but are still subject to variations caused by movements of foliage or tall objects in the wind. Atmospheric changes do not usually cause such rapid variations in signal strength. The value of σ changes so quickly with the aspect of a moving target that it is often possible to pick up a target, momentarily, above the radar horizon, at a range twice that at which it would be continuously visible.

The dependence of σ on the shape and size of surface vessels is given in Sec. 10-1. It varies from about 70 ft² for a 40-ft cabin cruiser to 80,000 ft² for a large freighter. The head-on aspect of a small Navy aircraft, SNC, was found to have an equivalent cross section of only 70 ft², less than 10 per cent of the value (800 ft²) for a four-engine airplane.

Metallic surfaces reflect more energy than nonconducting surfaces and give larger effective cross sections for objects of the same size. Ordinary paint does not markedly change the value of σ .

The relationship among the above factors can be very simply derived in the following manner. The area of the surface of a sphere of radius R is $4\pi R^2$. If an isotropic radiator with peak power P_t were at its center, the power falling on a unit area of the inside of this surface would be

$$P_t \frac{1}{4\pi R^2}$$

If an antenna of gain G replaced this isotropic radiator and if the maximum energy were directed toward this unit area, the power falling on it would be

$$P = P_t \frac{G}{4\pi R^2}. \quad (1)$$

When we substitute the effective cross section σ for this unit area we find that the target, now considered as a source, will radiate power in the direction of the antenna equal to $P_t \frac{G\sigma}{4\pi R^2}$. If A is the area of this antenna, then the fraction $\frac{A}{4\pi R^2}$ of this reradiated power, or $P_t \frac{G\sigma}{4\pi R^2} \frac{A}{4\pi R^2}$, will be intercepted and fed to the receiver. If the minimum signal power which can be distinguished from noise on the indicator is S_{\min} , the maximum range of the radar is such that this received signal is equal to S_{\min} , or $S_{\min} = P_t \frac{G\sigma A}{16\pi^2 R_{\max}^4}$.

If we now substitute the expression $G = KA/\lambda^2$ for the gain and solve for R_{\max}^4 , we have

$$R_{\max} = \left(\frac{K\sigma P_t A^2}{16\pi^2 S_{\min} \lambda^2} \right)^{1/4} = \left(C \frac{\sigma P_t A^2}{S_{\min} \lambda^2} \right)^{1/4} \quad (2)$$

where $C = K/16\pi^2$. Since, for an average antenna, K is about 5, $C = \frac{1}{32}$.

This "range equation" shows that the maximum range of a given radar on a target of cross section σ could theoretically be doubled by: (1) increasing the peak transmitter power or the observer-receiver sensitivity by a factor of 16; (2) increasing the area of the antenna dish fourfold; or (3) reducing the wavelength by a factor of 4.

This equation taken by itself does not give a complete picture of the problem of radar design. The quantity S_{\min} is affected by such factors as repetition rate, scanning speed, and pulse length, each of which in turn affects the observability of a given signal on the indicator. Technical limitations and the relationships among the factors involved have not yet been touched upon. These matters, together with considerations which influence the choice of wavelength, will now be discussed briefly.

Repetition Rate.—It is possible to decrease S_{\min} by increasing the repetition rate because this would effectively put more pulses on the target during a single scan and make the signal on the indicator sweep more easily distinguishable from random noise. It has been found experimentally that if the repetition rate is changed by a factor n , S_{\min} is changed by a factor of $n^{1/2}$ and the range is changed by a factor of $n^{1/4}$. If the repetition rate were doubled ($n = 2$), S_{\min} would be reduced by $\sqrt{2}$ and the range would be increased by only 9 per cent.

The time interval between successive pulses must be long enough to allow each pulse to reach the target and to return before the following pulse is transmitted. The repetition rate must, therefore, not exceed a

value compatible with the maximum range of the set. The average power of the transmitter tube depends directly on how often it is required to send out pulses. Its power capabilities often limit the repetition rate.

Because the range is improved and moving target indication (see Sec. 7-9) is more satisfactory, it is usually desirable, within the limitations mentioned in the previous paragraph, to make the repetition rate as high as possible. There is a very wide range in the repetition rates used with different radars; some operate at 60 and others at 4000 pulses per sec.

Scanning Losses.—Another consideration that enters into the value of S_{\min} is that of scanning losses.¹ The range of a radar system when its antenna is continuously scanning is not so great as it is when this antenna is continuously pointed in the general direction of the target. This latter condition is called "searchlighting."

The detectability of a weak signal (expressed as S_{\min}) is affected by the rate of scan for much the same reason that it is affected by the changes in the repetition rate. An experimental comparison between conditions of scanning and searchlighting has shown that S_{\min} is proportional to $(8/t)^{1/2}$, where t is the time in seconds during which pulses are striking the target on each scan. This relationship holds only for values of t less than 8 sec. If, for instance, the antenna rotates at 6 rpm, it scans 36° per sec. If the beam is 6° wide, pulses effectively strike the target for $\frac{1}{3}$ sec per scan. S_{\min} is then $(48)^{1/2}$ times as large as its value under searchlighting conditions and the loss in range is equal to $(48)^{1/4} = 1.62$. In other words, the range under searchlighting conditions is 1.62 times greater for a given target than if the antenna were rotating at 6 rpm. Thus it is evident that the ratio of beamwidth to scan rate governs the amount of scanning loss. To avoid excessive losses, a radar producing a narrow beam should be made to scan slowly.

Pulse Length.—Another factor which affects the range of a system is the pulse length. The random background-noise power of a receiving system, P_R , is directly proportional to its bandwidth and inversely proportional to the pulse length. Since S_{\min} is proportional to P_R , it is also inversely proportional to the pulse length. If the pulse length were doubled, the range would be increased by a factor of $2^{1/4}$, or 19 per cent.

The limitations imposed by lengthening the pulse are: (1) the loss in minimum range detection and in range resolution; (2) an increase in the signal return from clouds and ground clutter compared with the return from sharply defined targets; (3) considerations of permissible average transmitted power. In order to maintain the same average power as the pulse is lengthened, it is customary to reduce the repetition rate. The disadvantages in doing this have been previously outlined.

¹ A complete discussion of scanning losses is given in *Radar System Engineering*, Vol. 1, Radiation Laboratory Series.

A pulse length of 1 or 2 μ sec has been found to be a good compromise when reasonable range resolution and extreme ranges are required. A pulse length of $\frac{1}{4}$ or $\frac{1}{2}$ μ sec has been used to advantage in shipborne radar systems where range resolution and minimum range are more important than the detection of targets at great distances. Radar systems which can transmit either short or long pulses have proven satisfactory.

A useful summary of these factors affecting the minimum observable signal is given by the equation

$$S_{\min} = \frac{90}{(\text{PRF})^{\frac{1}{2}}} \left[\frac{\text{angle of scan in 8 sec}}{\text{beamwidth}} \right]^{\frac{1}{2}} P_R \quad (3)$$

The proportionality factor of 90 is an empirical constant that fits experimental data so that the approximate useful range of several representative systems can be calculated from Eq. (2) when the above expression is used for S_{\min} .

Choice of Wavelength.—We have seen from previous discussion that the directivity of the radar beam is increased as shorter wavelengths are used. This increase in antenna gain results in improved range performance and gives greater angular resolution for a given dish size. There are, however, several reasons why it is not always profitable to go the whole way and to use the shortest available wavelength—1.25 cm.

In the first place, the transmitter power available at 1.25 cm is roughly 25 per cent of that for 3.2-cm waves and only 5 per cent of that for 10-cm waves. The atmospheric attenuation, which is so pronounced at 1.25 cm, becomes less and less objectionable as longer wavelengths are used. The use of shorter wavelengths makes the mechanical tolerances of the antenna correspondingly more rigorous, because it is desirable to preserve the parabolic figure of the dish to one-eighth of the wavelength. If the radar is to be used primarily for scanning, a narrow beam would allow fewer pulses to hit the target than would a wide beam. The same arguments regarding the effect on range as a result of changing the number of pulses hitting the target apply here also. At least five pulses per scan are required for satisfactory operation with beacons (Sec. 1-9) and a minimum of 10 pulses per scan when MTI (Sec. 7-9) is used. Further considerations regarding the choice of wavelength appear in Sec. 7-1.

We see from the above discussion that although the range of a radar system depends primarily on only half a dozen factors, these factors are by no means independent of one another and must be weighed in such a way that the set can best carry out the job for which it was primarily designed.

A typical airborne radar designed for navigation is described in Sec. 6-3. One of the most powerful land-based radars ever used for the detec-

tion of aircraft in air surveillance problems is described briefly in Sec. 7-1, and in considerable detail in *Radar System Engineering*, Vol. 1. Although these two radars represent extremes in radar design, the arguments used have a certain degree of similarity and general application. A radar proposed for shipborne navigation is described in Chap. 10.

Experience has shown that for surface-based radars to be used for aircraft detection, which, therefore, require higher power and cosecant-squared antenna beams, a wavelength between 8 and 25 cm should be used. (A detailed analysis of this question is given in Sec. 7-1.) In the case of an airborne system in which weight and space are at a premium, small dishes and a wavelength either slightly longer or shorter than 1.25 cm would seem desirable. A shipborne navigational radar system can usually use moderate-sized dishes. Since the purpose of a shipborne system is to detect and locate the positions of surface vessels, icebergs, lighthouses, land surfaces, and buoys, a wavelength just enough longer than 1.25 cm to avoid atmospheric absorption and to permit the best possible low coverage near the horizon for a given antenna height would be most useful. Radio waves between 1 and 12 cm long are often called "microwaves." High resolution in both range and azimuth is required if the radar is to be used for pilotage purposes in narrow waters or in docking operations. Consequently, dishes as large as permissible, short wavelengths, and short pulses are desirable features of a shipborne radar system.

PROPAGATION

1-4. Curvature of the Earth and Atmospheric Refraction.¹—If we neglect the effects of the atmosphere, microwave radiation travels in straight lines; the curvature of the earth is an ultimate limitation on the range of any radar set. In practice, it is found that horizontal stratification of the atmosphere of the earth causes refraction of the microwave rays, usually bending them downward so that they tend to follow more closely the surface of the earth.

The effects of atmospheric refraction are usually unimportant for airborne radar sets because the wave path traverses the stratified layers at such large angles that refraction effects are not noticeable. In addition, the horizon is at such a great distance from high-flying aircraft that the limitation is in the radar set itself. For surface-based radars, however, for which the range limit is usually the horizon, refraction is important.

If a radar antenna is at height h_a above the surface of the earth, the geometrical distance to the horizon, assuming the radius of the earth to be 4000 statute miles, is given by the relation $D = 1.08 \sqrt{h_a}$, where h_a is in feet and D is in nautical miles. The geometrical distance to the

¹ By J. P. Nash.

horizon from a height of 100 ft is then 10.8 nautical miles. If there is a small target at height h_t above the surface, the total horizon range is the sum of the distances to the horizon from both transmitter and target, or $D = 1.08 \cdot (\sqrt{h_a} + \sqrt{h_t})$. For microwave radar energy, which is refracted more than light by the atmosphere, the factor becomes about 1.24.

If the formula $D = 1.24 \sqrt{h_a}$ is used to calculate radar-horizon distances, the result is the same as if rectilinear propagation were assumed on an earth with a radius $\frac{4}{3}$ the true radius of the earth. This is a convenient concept which makes it possible without loss of accuracy to draw diagrams with rays as straight lines rather than curved ones; the notion of a *radar earth* is universally used for such purposes. However, there is nothing hard and fast about the choice of $\frac{4}{3}$ as a conversion factor; it represents an average from many meteorological observations over a wide range of climatic conditions. Similar results are obtained when $\frac{7}{8}$ is used.

The $\frac{4}{3}$ value is based upon the assumption of "standard" refraction, which is defined as that resulting from a linear decrease in the refractive index of the atmosphere with height at a rate of approximately 1.2×10^{-8} per ft. Nonstandard propagation is briefly discussed in Sec. 10-1.

1.5. Atmospheric Attenuation.¹—The atmospheric attenuation of microwave radiation varies with frequency. It can be generally stated that although the effects are not serious at 3 and 10 cm, they are at 1.25 cm. We now discuss in turn attenuation by water present as rain, water present as clouds, and water present as vapor. Attenuation by nitrogen and oxygen and other components of the atmosphere is not usually important in these three bands. For wavelengths somewhat shorter than 1.25 cm, however, oxygen attenuation does become very large.

Attenuation resulting from precipitation occurs as a result of absorption and scattering of energy out of the beam by raindrops, sleet, snow, and so on. When the particles are very small compared with the wavelength, only absorption is important. As the ratio of drop diameter to wavelength increases, both absorption and scattering increase rapidly. For sufficiently large values of this ratio, scattering constitutes an appreciable fraction of the total attenuation; this occurs only for the largest drops and very short wavelengths, however. The energy remaining in the beam is reduced, with the result that weaker echoes are received. Evidence of this scattering is seen in Fig. 1-7 which is a photograph showing the echoes produced by 1.25-cm radiation scattered from the rain squalls and the dark shadows behind the centers of the squalls, indicating a considerable weakening of the beam because of this scattering. Figure 1-8 is a similar photograph taken through cumulus clouds

¹ By D. Halliday.

at 10,000 ft over the mouths of the Amazon. At 3 and 10 cm echoes from squalls are very often seen, but their shadows are less frequently observed.

A plot of some rainfall attenuation data presented by the Bell Telephone Laboratories is shown in Fig. 1-9.

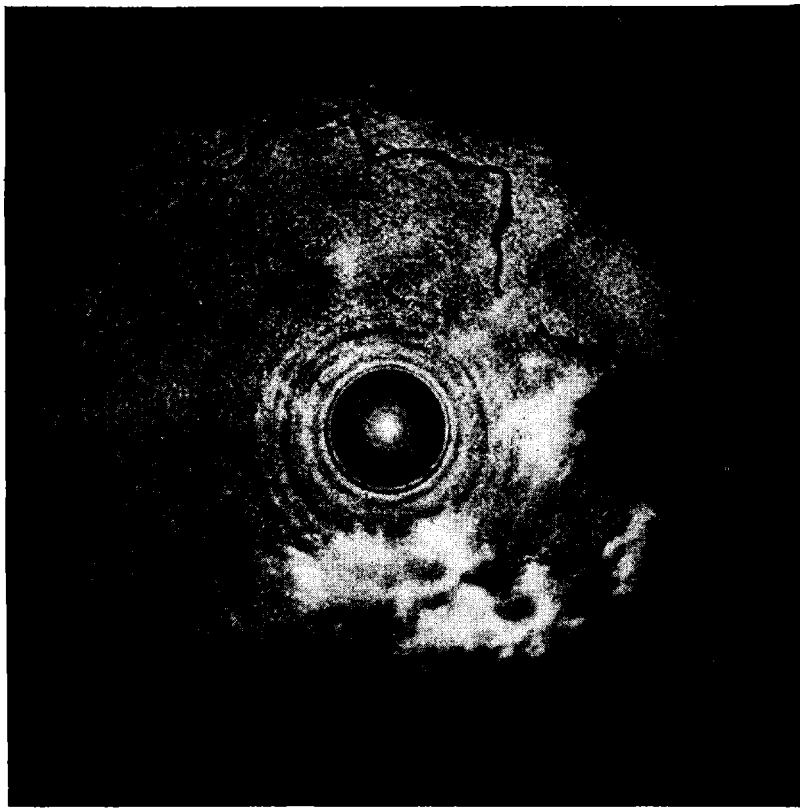

FIG. 1-7.—Rain squalls as seen on the PPI of an airborne radar 10,000 ft over French Guiana. The radius of the picture is 10 nautical miles (10-mile sweep). Clouds and their shadows appear at position angles corresponding to 3 and 4 o'clock.

This figure shows the precipitation rate necessary to reduce to one half the "no rain" range of any given radar system, assuming no change in absolute humidity. If a 1.25-cm radar can barely detect a ship at 30 miles on a clear day, it will barely detect the same ship at only 15 miles when a rainfall of 10 mm per hr (medium rain) occurs throughout the 15-mile path. Heavy rainfalls usually occur only over small areas at any one time, so that the high attenuations implied by the curve of Fig. 1-9

will usually be applicable only to rather short segments of the optical path. Note that the attenuation effects decrease with increasing wavelength. A rough average for attenuation at 1.25 cm is 0.3 db (7 per cent) per one-way nautical mile per millimeter of rain per hour.

Attenuation by clouds is rarely important on any microwave band except when the clouds contain water in the form of rain. Many clouds

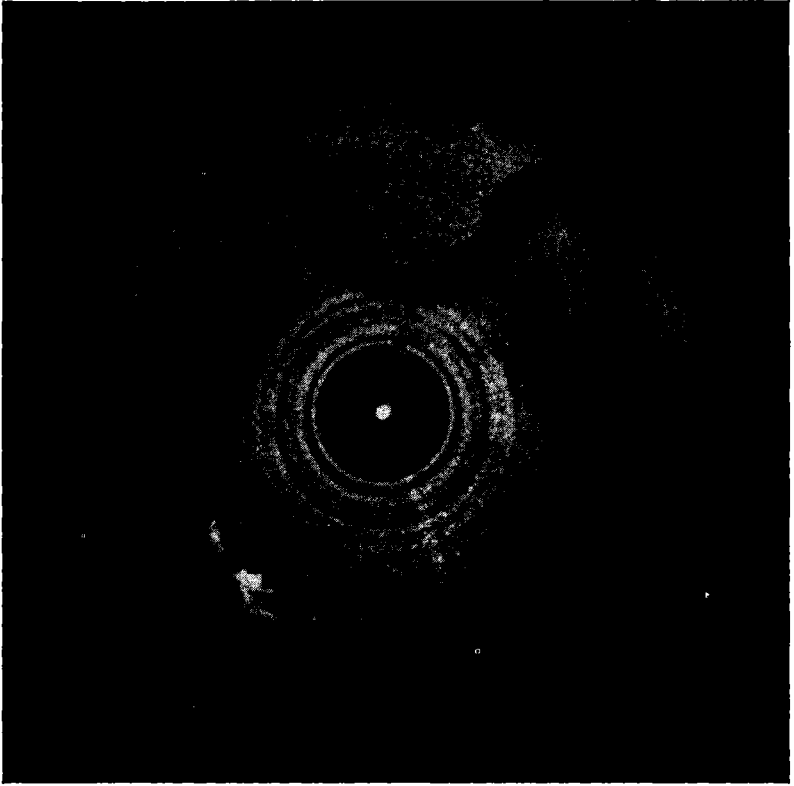

FIG. 1-8.—Looking through cumulus clouds at the mouths of the Amazon from 10,000 ft. A small rain squall appears at 7 o'clock.

contain water only as mist or fog in which there is some absorption but not much scattering. For example, the cumulus "woolpack" clouds commonly seen on a summer afternoon give no radar echoes, indicating that the water particles are very small. Similarly, the sheetlike stratocumulus formations, which often pile up to thicknesses of 10,000 ft over large areas, usually produce little attenuation. The ground can be mapped through them to practically free-space range with no appreciable difficulty, at least at wavelengths as short as 1.25 cm.

The third form of attenuation is caused by water vapor. This is a true molecular absorption process in which the microwave energy is absorbed by the individual molecules and reradiated in all directions. Its magnitude is very small at 10 and 3 cm, but unfortunately it reaches a maximum almost precisely at the center of the 1.25-cm band. This unhappy state of affairs exists because this waveband was chosen and components were designed and built before the water-vapor absorption data were available.

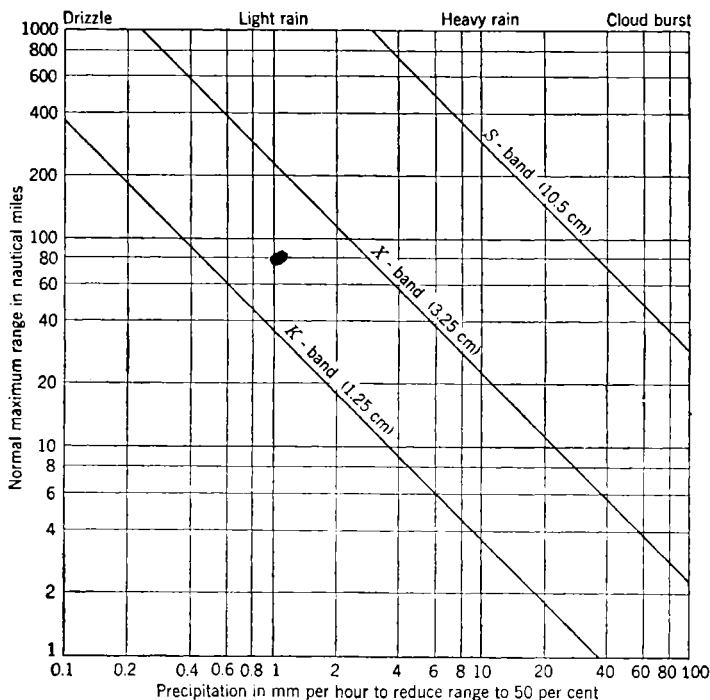

Fig. 1-9.—Loss of radar range due to precipitation. (Courtesy of Bell Telephone Laboratories.)

It is now known that at a wavelength of 1.25 cm, the sea-level water vapor attenuation coefficient is about 0.04 db per one-way nautical mile per gm $\text{H}_2\text{O}/\text{m}^3$. The water-vapor content of saturated or nearly saturated air increases rapidly with temperature. For temperate climates (Boston) the absolute humidity of water vapor may range from 1 gm $\text{H}_2\text{O}/\text{m}^3$ on dry winter days to 18 gm $\text{H}_2\text{O}/\text{m}^3$ on moist summer days. In the tropics, values of 50 gm $\text{H}_2\text{O}/\text{m}^3$ are possible. Since a 12-db absorption is required to halve the range at which a discrete target can be barely detected, it is evident that if a target can be seen at 15 miles on a

day when the absolute humidity is $10 \text{ gm H}_2\text{O/m}^3$ it could be seen at 30 miles on a perfectly dry day.

One interesting characteristic of water-vapor attenuation is its variation with altitude. The density of water vapor in the atmosphere—the absolute humidity—decreases fairly rapidly with altitude as shown by Fig. 1-10, which is a mean curve for July 1942 at Charleston, S.C.

In addition the actual value of the attenuation coefficient also decreases with altitude because it depends on pressure. In the situation described by Fig. 1-10 calculations for an aircraft at 25,000 ft show that an echo at zero elevation 20 miles away is reduced in intensity by about 11 db through water-vapor attenuation.

If this path were entirely at sea level, the attenuation in this case would be 31.2 db for the 40-mile round trip. The conclusion is that water-vapor attenuation for airborne radars can be reduced by flying high.

Because 1.25-cm radar systems have discouragingly short ranges in humid weather, a shift in wavelength for this band has been suggested. Two proposals have been made. If azimuth resolution is to be the most important criterion, some wavelength region close to 0.9 cm should be chosen. If azimuth resolution can be sacrificed to achieve a better maximum range performance, a band near 1.8 cm would be suitable. The water-vapor attenuation for both of these suggested bands is considerably

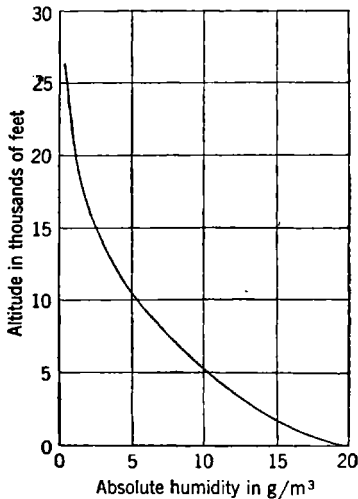

FIG. 1-10.—The mean decrease of absolute humidity, with altitude, for July 1942 at Charleston, S.C.

less than at 1.25 cm. At 0.9 cm there is appreciable attenuation because of oxygen absorption, but it is less than commonly encountered water-vapor attenuations at 1.25 cm. As the wavelength decreases, scattering and absorption by rain become progressively worse, however. The ultimate choice must involve a consideration of the reduction in reliability from this effect as well as the other factors mentioned above.

INDICATORS

1.6. Cathode-ray Tubes.¹—A cathode-ray oscilloscope tube has three essential parts: an electron gun, a luminescent screen and, between them, a deflection system. The electron gun is very similar to an ordinary

¹ By R. M. Whitmer.

triode vacuum tube. It has a hot cathode which emits electrons, a grid to control the electron flow, and a positive anode to which the electrons move. However, the anode of the CRT has in it a small hole through which some of the electrons pass to continue their trajectories beyond (see Fig. 1-11).

The far end of the tube, at right angles to the beam of electrons emerging from the anode, is coated on the inside with material which emits light when struck by the electrons. This is the luminescent screen. If the beam is undeflected, it will strike the screen at the center and cause a spot of light there.

The beam may be deflected by passing it through an electric or a magnetic field at right angles to its original direction. Thus, in Fig. 1-12, the beam is bent upward by the electric field between the first pair of plates, and outward by that between the second pair. It strikes the screen above and to the left of center. By applying the proper voltage to the plates the beam may be made to strike anywhere on the luminescent screen. The same things can be done with magnetic fields, but the beam is then bent at right angles to the magnetic field, as is shown in Fig. 1-13. These two systems are known as electric and magnetic deflection, respectively.

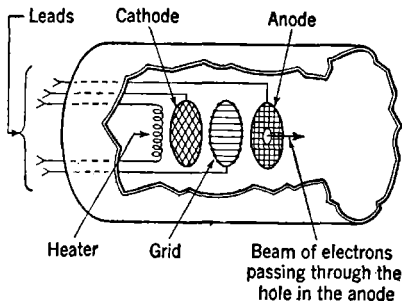

FIG. 1-11.—Electron gun of a cathode-ray tube.

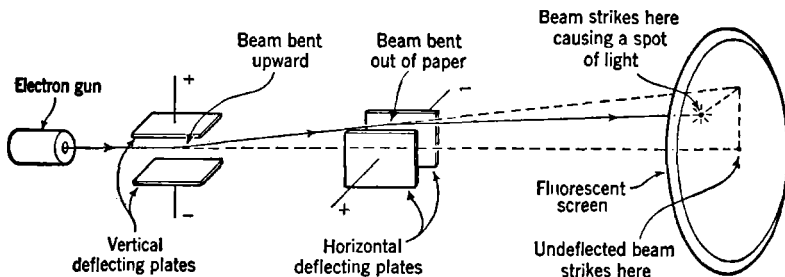

FIG. 1-12.—Electric deflecting system and luminescent screen.

A single properly oriented electric or magnetic field could bend the beam in any direction. It is impractical to produce a deflecting electric field with external, rotatable electrodes; consequently, two pairs of plates are always used in electric systems. However, a single magnetic field, developed outside the glass envelope of the tube, is frequently

used. This is shown in Fig. 1.14. Here the direction of deflection may be controlled by rotating the magnets about the axis of the tube. If we replace the bar magnet by solenoids, the amount of the deflection may be controlled by varying the current in the coils.

It is highly desirable for the cross section of the beam to be small when it strikes the luminescent screen—in other words, for the beam to

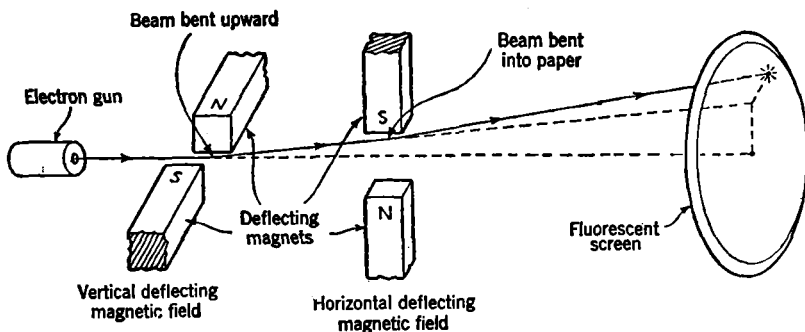

FIG. 1.13.—Magnetic deflection system.

be well-focused. Focusing may be done by additional electrodes in the electron gun assembly or with axial magnetic fields. Ordinarily there are about 200 spot diameters to 1 tube diameter, although good tubes may be somewhat better than this. The number of spot diameters determines the limit of resolution and gives a measure of the speed of deflection which can be used with a given pulse length. Thus, on a

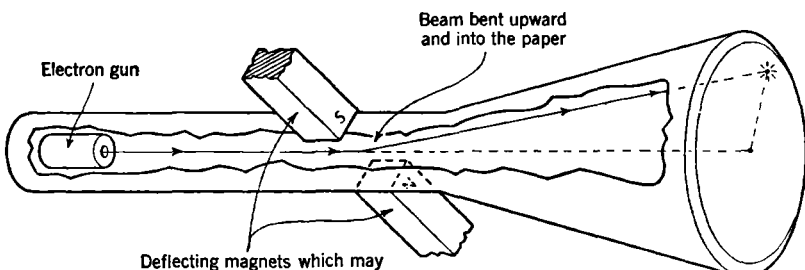

FIG. 1.14.—Magnetic deflection system with a single pair of magnets.

trace of a radius of 1 nautical mile, a spot diameter is about 20 yd, which corresponds to a pulse length of $\frac{1}{3}$ μ sec.

1.7. Synchros, Servomechanisms, and Amplidyne.¹—The applications of synchros, servomechanisms, and amplidyne are not confined to radar, but because they are frequently used as a means of transmitting

¹ Sections 1.7 and 1.8 by R. M. Whitmer and R. E. Meagher.

angular information from the antenna to the indicator it seems appropriate to describe them briefly here. A more detailed discussion is given in Vols. 26 and 27 of this series.

A synchro is a device for transmitting mechanical data electrically. The datum to be transmitted is usually the instantaneous position of a rotating shaft—by electrical means one shaft is made to follow another, in angular position as well as angular velocity. A common device of this sort is the "Selsyn" (for "self-synchronous") manufactured by the General Electric Company.

A servomechanism is sometimes used where a synchro system would not be able to supply sufficient torque nor have sufficient stability of

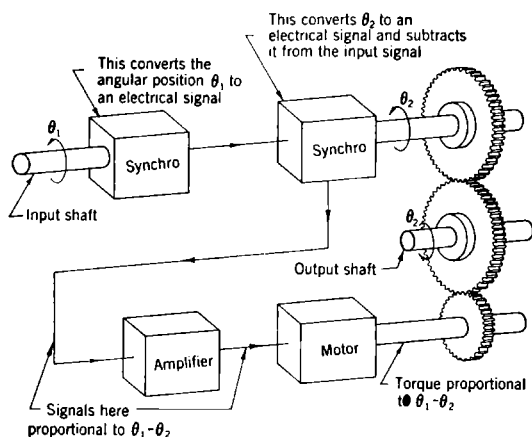

Fig. 1-15.—Block diagram of a servomechanism. The object is to make the output shaft (θ_2) follow accurately the position of the input shaft (θ_1).

position. A pair of synchros is used, but the receiving unit does not exert any torque. Instead, it puts out an electrical signal proportional to the difference between the positions of the input and output shafts. This signal is fed through an amplifier to a motor which drives the output shaft directly, as shown in Fig. 1-15.

A torque amplifier is a special form of electromechanical power amplifier. It is essentially a d-c generator and motor; the generator is driven at constant speed by a second motor. The field current of the generator is controlled by an electronic amplifier whose input is proportional to something corresponding to the $\theta_1 - \theta_2$ of Fig. 1-15. The generator output voltage is used to drive a d-c motor. The generator and d-c motor are specially designed to combine small time constants (short delays) with large output torques. The Amplidyne (a G-E product) may be used as the final stage of the servomechanism amplifier, allowing

accurate and rapid orienting of a large and heavy piece of equipment by means of a very small controlling power.

1-8. Different Types of Indicators.—In the simplest type of indicator, an A-scope, the received signal amplitude plotted as a function of range is presented on the tube screen. All other indicators in common use are of the intensity-modulated type. The amplitude of the received signal controls the intensity of the electron beam in the cathode-ray tube by means of the grid in the electron gun and hence affects the brightness of the spot on the screen. Indicators of this type which are particularly useful for navigation are the PPI, the delayed PPI, the off-center PPI, the B-scope, and the range-height indicator, RHI.

A-scope.—The A-scope uses sidewise electric deflection. A voltage of amplitude proportional to time—and hence proportional to distance to the target—is applied to the horizontal deflection plates, and the signal voltage to the vertical plates. Although the A-scope was historically the first indicator used, it is now often used only as an auxiliary indicator for test or other special purposes. It is easy to make adjustments using it because small changes in signal amplitude are easily observed. An A-scope with a “step” is useful in measuring range since the position of the step (Fig. 1-16*b*) can be set by a manual control and read from it accurately.

The phenomena observed on the A-scope are cyclic; each sweep shown in Fig. 1-16 is retraced once for each pulse sent out by the radar transmitter. Since some hundreds or even thousands of pulses are transmitted each second, the picture appears stationary to the eye.

The PPI.—The most useful indicator is the PPI, which was discussed briefly in Sec. 1-2. It presents a polar-coordinate plot of signal range against bearing. Successive sweeps are made to assume a direction which corresponds to the antenna bearing by synchronizing the rotation of a magnetic deflection coil with that of the antenna. Because most antennas scan at speeds between 5 to 30 rpm, it is necessary to use a cathode-ray tube screen with high persistence to provide a continuous pattern of radar signals. The screen must have a fine structure to provide good resolution and a multiple-layered composition to obtain long persistence. The coating designated as “P7” is most commonly used on PPI’s.¹ When an area of the screen covered with this or similar coatings is struck by the electron beam, it emits a flash of bright blue light. As the beam moves on, the blue light disappears, but for some seconds the area glows with an orange color. The blue flash is very annoying to the eye, and it is so intense that observation of detail is often difficult. An orange filter, which suppresses the blue flash, is usually placed over the screen, making it easy for the operator to observe

¹ See *Cathode-ray Tube Displays*, Vol. 22, Radiation Laboratory Series.

detail in the regions emitting persistent orange light. Figure 1-17 shows a photograph of an ordinary PPI on a shipborne radar together with an aerial photograph of the same region.

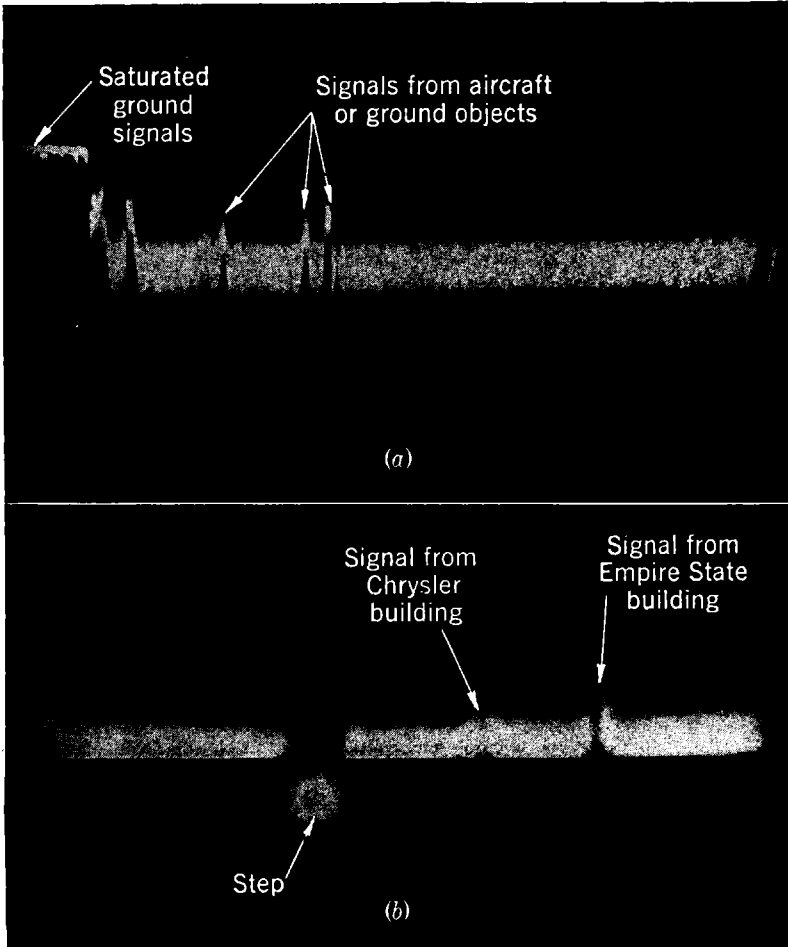

FIG. 1-16.—A-scope presentation. In (a) ground signals saturate the receiver for the first few miles. Several unsaturated ground echoes are evident at greater ranges; (b) was made at Bridgeport, Conn., and shows echoes from the tops of two buildings in New York City, 47 nautical miles away. This is a 5-mile delayed sweep showing a range step. Photograph made at General Electric plant by G. W. Fyler.

It is often desirable to see nearby signals on a more expanded scale than that used for distant signals. Therefore the PPI usually has several ranges from 1 mile to 50 miles or more.

In order to augment the usefulness of a PPI, it is customary to present range markers and some reference bearing mark in addition to the radar signals. Fixed range marks form rings on the scope and reduce to some extent the requirements for precision and linearity of the PPI sweep itself. The sweeps are said to be linear if two targets at ranges of,

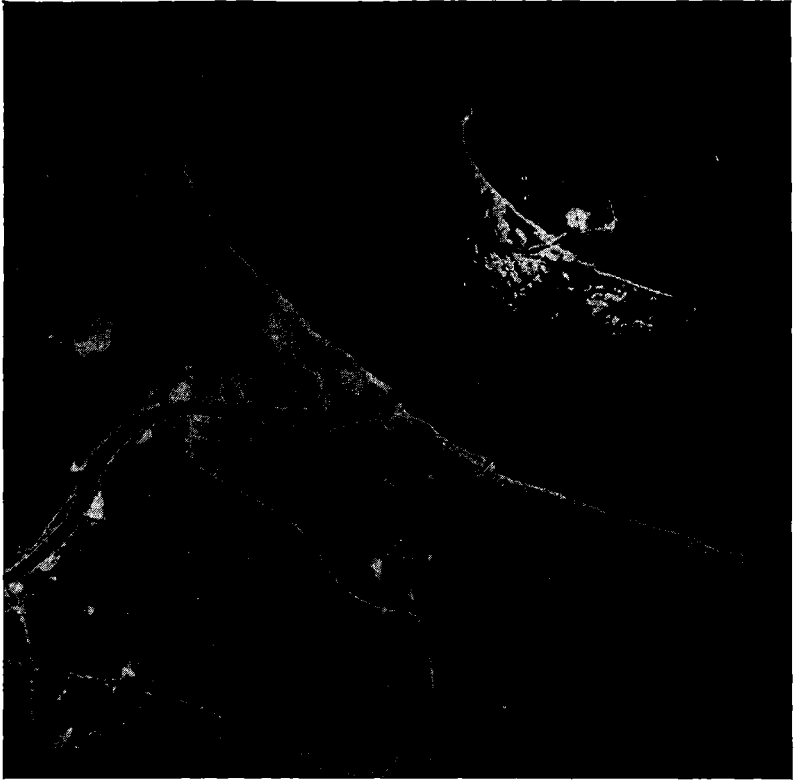

FIG. 1-17.—Aerial photograph showing the Sagamore entrance to the Cape Cod Canal, and a PPI photograph of the same region. The PPI photograph was made with a shipborne radar, and range rings are 1 mile apart. (*Aerial photograph courtesy of Aero Service Corporation, Philadelphia.*)

say, 1 and 2 miles appear on the screen with the same radial separation as two other targets at 15 and 16 miles.

PPI presentation can be obtained by many circuits of several fundamentally different types. The design of a PPI for navigation must be governed by the following requirements: very good linearity, even with fast (1-mile) sweeps; accurately known delay in starting; and accurate bearing data.

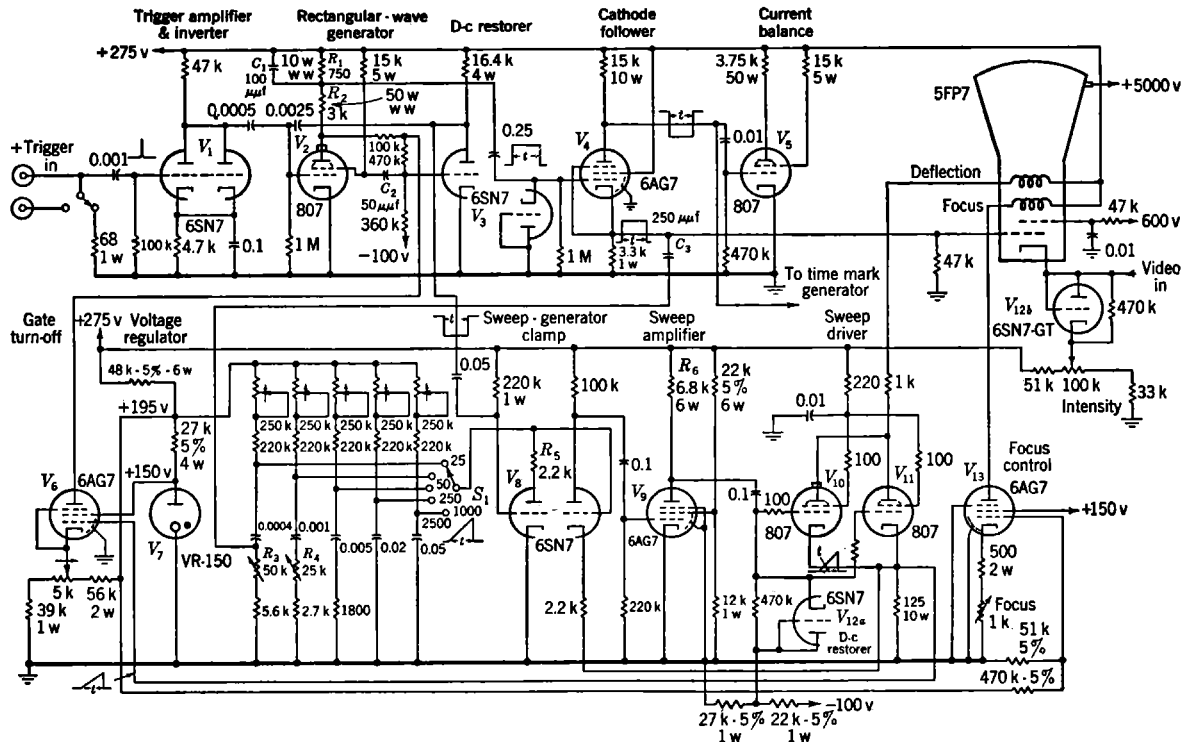

FIG. 1-18.—A typical high-quality rotating-coil PPI circuit.

There are three methods of generating the magnetic deflecting fields for a PPI. In the first, known as MM (Magnetic-Mechanical) or rotating coil method, a single pair of deflecting coils (corresponding to the two bar magnets in Fig. 1-14) is used. The variation of current through these coils produces the radial sweep of the electron beam. The coils are rotated mechanically about the axis of the cathode-ray tube in synchronism with the scanner rotation. Each of the other two methods uses two pairs of fixed coils. The relative phases of the currents through them are such that they produce a resultant magnetic field which rotates about the axis of the tube. This is very similar to the rotating field in an induction motor. The currents may be applied directly, as in the MS (Magnetic-Selsyn) or resolved current method, or through a level-setting and ampli-

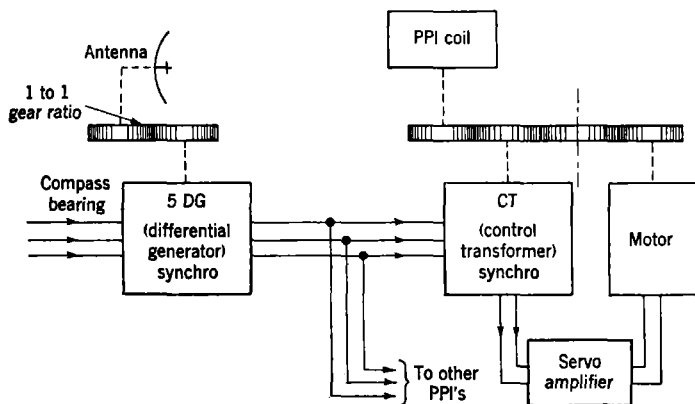

FIG. 1-19.—Typical bearing transmission circuit for a ship navigation radar.

fying stage as in the ME (Magnetic-Electric) or resolved voltage method. Further details are given in Vols. 1 and 22 of this series.

A PPI of the rotating-coil type has been commonly used for ship navigation because of its excellent linearity and accurate presentation of azimuth. This type of PPI is particularly useful when a large number of remote PPI's are required. A good PPI circuit is shown in Fig. 1-18.¹ In this design a small servomechanism is used to turn the rotating coil in synchronism with received bearing information as shown in Fig. 1-19. In this system, the errors in transmission of azimuth data have a value not exceeding $\frac{3}{4}^\circ$, which is probably less than the errors in reading azimuth on the tube. Other, less accurate designs are usually used in airborne radars because of their light weight.

An expanded picture may be obtained by delaying the start of an ordinary PPI. When economy of parts is required, this is a simple and

¹ A detailed explanation of this circuit is given in Vol. 22, of this series.

effective way of obtaining expanded indication. The pattern is highly distorted; for example, if a 25-mile delay be introduced, all targets at 25 miles will appear superimposed at the center of the screen. The effect is similar to that which would be observed if a map were printed on a handkerchief whose center is placed over a hole formed by the thumb and forefinger of one hand, and part of the handkerchief drawn through the hole with the other hand.

A further modification of the PPI appears to be nearly ideal: the center of rotation of the PPI beam can be moved so that it is no longer the geometrical center of the tube face. Indeed, if the center of rotation could be moved anywhere and at the same time a wide range of sweep

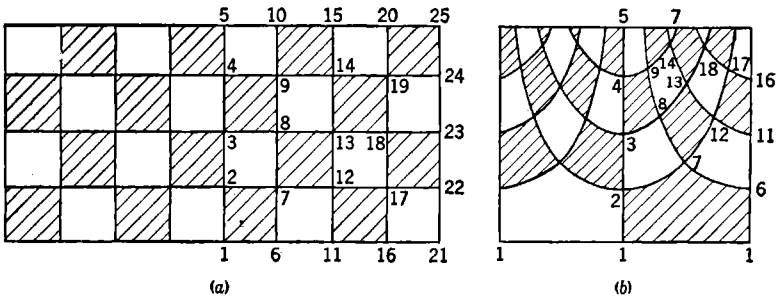

FIG. 1-20.—A true map (a) and a B-scope map (b) of the same region. The point 1 of (a) has become the line 1-1-1 of (b). The line 1-5 of (a) is undistorted, but the other straight lines of (a) have been bent. They can be traced from the numbers on their intersections.

speeds could be provided, this would be the best kind of presentation. The advantages of delayed sweeps and expanded scales could then be had without the distortion which normally accompanies these features. Arrangements to move the center off the tube by a distance of one radius are fairly simple, but if a displacement of several radii is needed, the problem becomes difficult. For more than two or three radii a fixed-coil system is required which compromises to some extent some of the other desirable features.

B-scope.—A B-scope is an intensity-modulated indicator in which azimuth is plotted horizontally and range vertically on linear scales. The resulting distortion is very great at short ranges. In Fig. 1-20, it is shown that the position of the radar (point 1 on the map) is extended to the entire base line of the B-scope. The distortion makes it difficult for any but an experienced operator to correlate the B-scope presentation with a map. Nevertheless, just this sort of short-range “blowing up” is very desirable in certain applications.

If the B-scope range is delayed and the width of the screen is made to correspond to only a few degrees of azimuth, the distortion is small.

This sort of presentation is very similar to the off-center PPI, but the circuits for obtaining it are considerably simpler. It is frequently used, therefore, to examine on a large scale a small part of the field which the radar covers.

RHI.—The range-height indicator, RHI, is used for the presentation of height data from systems that scan in a vertical plane. The indicator is intensity-modulated, range is plotted horizontally, and height vertically. The scales are linear, but the height scale is more expanded than the range scale; for example, an inch measured vertically on the indicator screen may represent 10,000 ft in height, whereas an inch measured horizontally measures 10 miles. Typical RHI pictures are shown in Sec. 7-5.

RADAR BEACONS

BY R. M. WHITMER AND J. B. PLATT

1-9. Operation.—A radar beacon, sometimes called a “transponder,” consists essentially of a receiver which picks up pulses from a radar transmitter, and a transmitter, triggered by the output of this receiver, which puts out signals to be detected by the radar receiver. The beacon might be called a device for giving an amplified echo. When a radar causes a beacon to operate it is said to be “interrogating” the beacon.

Because radar-to-beacon and beacon-to-radar transmissions are each one-way, the signal intensities vary as the inverse square of the range rather than as the inverse fourth power, as do ordinary radar echoes. This means that the range of a radar beacon may be doubled by increasing the radar transmitter power or the receiver sensitivity fourfold, whereas a 16-fold increase would be required to double the range on ordinary echoes. Also, the power transmitted by the beacon is independent of the strength of the interrogating signal. Hence, beacon signals may be seen by radars at much greater distances than may ordinary echoes. *Usually the range is limited only by the horizon.*

Distinctions between Echoes and Beacon Signals.—For most applications in the microwave region, the frequency of the beacon transmitter is not the same as that of the radar transmitter. This means that the radar receiver must be retuned in order to receive the beacon. Otherwise, a second receiver must be used. In either case, normal echoes and beacon signals may be presented separately. In addition, the microwave beacon usually replies with a series of two to six pulses so spaced that they appear to be 1 to 3 miles apart in range, all at the same azimuth, rather than with a single pulse for each pulse received. This distinctive group of signals cannot be mistaken for an echo from a normal target. The spaces may be used to identify the beacon. The first of this series of pulses reaches the radar receiver at very nearly the same instant as would a normal echo from a target at the position of the beacon. On a scanning

radar, the first beacon signal shows the relative positions of beacon and radar; the others identify the beacon. Thus, observation of a single beacon gives range, azimuth, and identification. Figure 1-21 shows a beacon response on a PPI.

The transmission of a series of pulses is called range coding. At the present time only two lengths of spaces between pulses are used, "short" and "long." The codes are "named" by counting the number of pulses

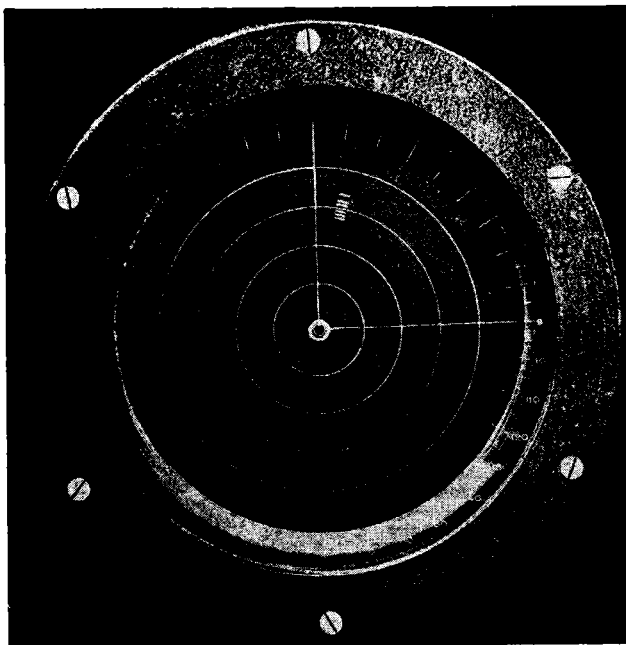

FIG. 1-21.—Microwave beacon at relative bearing 12°, range 27 miles. Code 3-2-1. (Another PPI photograph showing beacon replies is shown in Fig. 6-11.)

having short spaces between them; thus the code \dots is called 3-2-1, and \dots is 2-2-2. Other types of coding and their uses are discussed later.

Application.—The use of beacons permits one to see a small number of identifiable points on the radar screen, while confusing aggregates of targets and all spurious clutter may be completely eliminated from the scope. This is particularly useful in navigation. During the war, crews of military aircraft relied heavily on radar beacons. They have not yet been used for surface navigation; here the horizon limitation on range is much more severe, but for inshore navigation and pilotage, the advantages of obtaining accurate fixes from shore points are very real.

Beacons have also been installed in aircraft for use with airborne and ground radar, for identification or increase in effective range or both. In the future they may also be used for limited communication.

During the war, many ground beacon stations were set up in the United States as well as abroad for use with airborne radars. Since the end of hostilities the United States Coast Guard has been made responsible for their maintenance, just as in peacetime it is responsible for a number of other types of navigational aids. Hydrographic Office Publication No. 520 contains a list of beacon locations, operating hours, codes, and

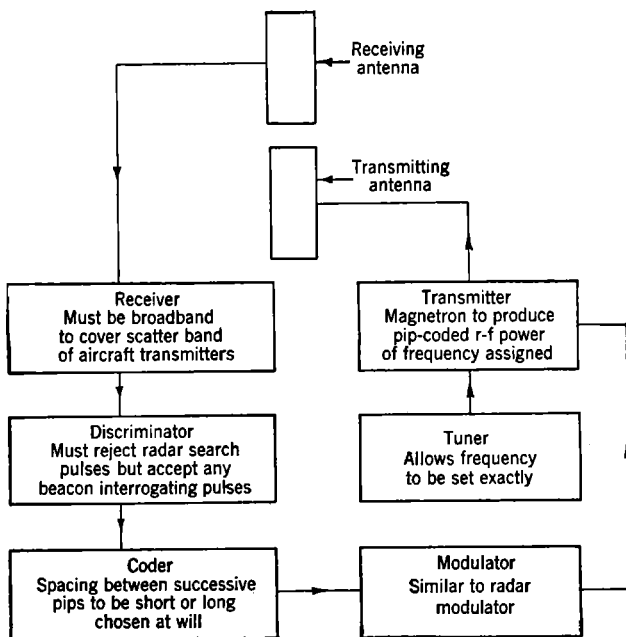

FIG. 1-22.—Block diagram of a radar beacon.

etc., while HO No. 520A has a series of charts showing in detail the coverage afforded by these facilities. "Weekly Notices to Airmen" and "Notice to Aviators" list changes in radar beacons as they occur. Included in the types now in use are beacons at frequencies from 200 to 10,000 Mc/sec (wavelengths of 150 to 3 cm).

All these applications are discussed at greater length in other sections of this book.

Equipment.—(See Fig. 1-22). Since it is usually desired that a beacon station may be interrogated by a radar from any direction, the beacon antenna can have no directivity in azimuth. If the interrogating radar

is at any appreciable distance from the beacon, the radar-to-beacon line is very nearly horizontal. Conversely, when the radar-to-beacon line is not approximately horizontal—as is the case when an aircraft is almost directly above a ground beacon—the range is very short. Hence, the antenna pattern must have a strong maximum in the horizontal direction but it does not need high gain at high angles. Because of this omnidirectionality in azimuth, the gain of a beacon antenna is much smaller than that of a radar antenna. Separate but identical transmitting and receiving antennas have been used, but TR switches satisfactory for beacons are now available so that a common antenna is practicable.

In the microwave region it is neither practical nor desirable to adjust each radar transmitter to exactly the same frequency, yet a beacon must be able to receive signals from any of them. In practice this has meant that a beacon receiver designed for a certain nominal frequency was required to cover a frequency band that might be 1 or 2 per cent wide, which at microwave frequencies may mean as much as 100 Mc/sec. This is called the scatter band because the frequencies of the different radar transmitters are scattered throughout it. The sensitivity of such a receiver cannot be made greater than from 1 to 10 per cent of that of a radar receiver for the same nominal frequency, but because it is used only with one-way transmission this low sensitivity and the small antenna gain do not usually limit the useful range from interrogator to beacon.

If many radars are within interrogation range and the beacon is operated by each pulse that it receives, the resulting demands on the beacon transmitter may well be excessive. This could happen even though none of the radars were deliberately interrogating the beacon. In order to reduce these demands, some sort of interrogation coding is frequently used. In the simplest and commonest form, the beacon is so designed that it will not reply to a normal radar search pulse, but only to a pulse of a certain specified length. Since the beacon does not reply until the length of the received pulse has been "measured," a small delay in range is introduced; the delay amounts only to about 300 yd, and compensation may be made for it in the radar sweep circuits. The unit in the beacon that measures the length of the received pulse is called the discriminator. In some specialized applications, discriminators are not used.

If two radars are interrogating the same beacon and both scanners are pointed toward it, each operator will see the beacon's replies to the other. These are easily interpreted as false signals because they are unsynchronized; that is, since the pulse recurrence rates are never exactly equal for different radars, the "false" signals appear at a different range on each scan, while the "true" beacon replies always appear at the same range. But if a large number of radars interrogate the same beacon simultane-

ously, each will see so many false signals that it may be difficult to find the true ones. This was observed on airborne radars when they were interrogating beacons near airfields. Interrogation coding prevents this condition from arising often.

Beacon Transmitter Frequency.—In order that all radars operating in a given frequency band can receive all beacons at will, an assignment of a spot frequency for the beacon transmission is made; both the beacon transmitters and the radar receivers must be accurately tuned to it. Standard cavities, which pass energy of only one frequency, are used for reference, just as quartz crystals are used at lower frequencies. The frequency chosen is a little outside the scatter band to avoid interference with the echoes of any radar set. Because of the one-way transmission, the required transmitter power is appreciably smaller than that of a radar transmitter.

Special Provisions in the Radar.—At the radar set, it is necessary to alter the pulse length and to retune the receiver in order to interrogate and receive the beacon. Usually the pulse-repetition frequency is changed, also, to keep the average power output constant. These operations are all performed by throwing a single switch from "search" position to "beacon" position. If the radar set does not have automatic frequency control some manual tuning will also be necessary. In either case a standard cavity is used as a frequency reference.

In the radar-plus-beacon system we have two distinct transmission-reception links. The maximum range on the interrogation (radar-to-beacon) link is determined by one set of factors, while the response range (beacon-to-radar) is limited by another set. It is desirable for these two range limits to be equal. This is accomplished easily if all the radars designed to operate with a given group of beacons are identical, but differences among the radars may affect the two range limits differently. For example, consider two which are identical except for transmitter power. The radar having the greater power can interrogate the beacon at a greater range, but the range limits for receiving the beacon are the same for both radars.

Future Developments; Coding.—The simple range-coding system mentioned above is the only one which has been used for microwave beacons in the past, and it is the only practical one which can be "read" directly from the radar indicator. The total number of distinct codes which this system gives is about 50, if the number of pulses does not exceed six. This is sufficient for identification of ground and shore navigational beacons because codes may be repeated without confusion with sufficient geographical separation.

For other applications, more codes are needed. The electronic techniques which would be used for more elaborate coding and decoding are

already well developed, but since they have not been put to this particular use only rough estimates of relative complexity and weight can be given. Among these systems are:

1. **Space-coding.** This is an obvious generalization of range-coding. Instead of allowing only short and long spaces between beacon reply pulses, the spaces may be varied in steps of, say, 1 μ sec. If only three pips, with spaces of from 1 to 10 μ sec, are used, 100 codes are available. Using six pips, this number is increased to 100,000. The coder would be very similar to those now in use, but the tolerances on components and voltages would be much closer. A decoder would be required in the radar.
2. **Pulse-width Coding.** In this system, the spacing between pulses is kept constant, but the width of each pulse in a reply series may be varied. The range of practical pulse width is less than that of the spaces; probably 1, 2, and 3 μ sec would be used. Four pips here give 81 codes and six give 729. The coder and modulator in the beacon would be heavier and more complex than those now in use, but not seriously so. It would again be necessary to use a decoder in the radar. All such proposed systems meet with difficulties if two or more beacons are likely to be situated so that their replies overlap each other, as might happen if they were carried in aircraft flying close together.

Other systems, such as frequency-coding (the beacon replying on two or more radio frequencies simultaneously), and time- or gap-coding (in which the beacon is insensitive for periods as long as seconds), have been conceived, and gap-coding has been used but it is out of the question with scanning radar sets.

Combinations of space- and width-coding may be used to give enormous numbers of distinct codes. For instance, if three pips, each 1, 2, or 3 μ sec long are used, with spaces variable from 5 to 25 μ sec in steps of 1 μ sec, we have 10,800 codes. The total is increased to 648,000 if four pips are used.

Such systems probably will be most practical for ground or shore radar sets working with airborne or shipborne beacons. Fortunately, these are just the applications in which a large number of codes are needed for identification.

1-10. Future Developments; Systems.—The description given here applies to microwave radar beacons as they were used during the war. Three narrow and widely separated frequency bands were used for airborne radar, and beacons were designed for two of these bands—the scatter bands mentioned above. In order to give navigational service

to all airborne microwave radars, each ground beacon station was required to have distinct beacon equipment for each of the two bands.

Actually, a far greater number of beacons operating outside the microwave region (in the neighborhood of 200 Mc/sec) were used, because they were developed earlier. Their use was somewhat different and suggests a different approach to the beacon problem.

Most of these low-frequency beacons were used in the IFF system (Identification, Friend or Foe). The objective was to equip every friendly ship and aircraft with a beacon whose reply would establish the friendly character of the vessel or airplane. Obviously, because all beacons of this system had to be alike to be of any use, it was necessary to supply extra interrogating equipment to operate in conjunction with the great variety of radar sets at different frequencies. In a similar way, the British developed such supplementary equipment to enable aircraft carrying radars which operated at many different frequencies to interrogate beacons in the 200-Mc/sec region.

Some problems can be solved entirely by the use of beacons and interrogating equipment which does not display radar echoes at all. Such an apparatus is called an "interrogator-responsor." This equipment can be made somewhat simpler than a true radar set, especially if only range or relatively inaccurate determination of azimuth will suffice.

The designer of a navigational system should, therefore, consider these three combinations of equipment:

1. Beacons with simple interrogator-responders that are not complete radar sets.
2. Separate-band beacons which are in a special frequency band set aside for the purpose, with supplementary interrogating and receiving equipment added to the radar sets.
3. Beacons to operate directly with the radar sets at the radar frequencies.

If the designer concludes that it is not necessary or desirable to plan for the radar use, he should be quite clear as to why not. The extra complication required to achieve radar performance would seem to be small compared to the probable value of the radar information.

If the primary function is to be the radar use, but beacons are also desired, the problem is to decide between the use of separate-band beacons and radar beacons. There seems to be no obvious solution that is best for all cases. The use of radar beacons requires the design, installation, and maintenance of a whole new set of beacons for every band of frequencies used for radar. It is feasible only if the frequencies of the radar sets to be so used are kept within a relatively small number of fairly narrow bands. On the other hand, it automatically guarantees

beacon signals that can be most advantageously displayed by the radar sets and obviates the necessity of adding more equipment to them. For airborne radar sets, in particular, this is important since the interrogator-responder is likely to require extra weight and bulk that are very appreciable fractions of those of the radar alone. The use of the separate-band beacons greatly decreases the number of beacons required and allows unrestricted utilization of the whole frequency spectrum for radar purposes. There is the disadvantage, however, of having to add the extra interrogator-responder with special antennas to every radar set, as mentioned above. Also, if the beacon frequency is much different from that of the radar, the signals are not likely to be such that they can be displayed to best advantage by the radar indicator. The question must be settled for every use, but in so doing, it is desirable to consider the systems as comprehensively as the prospects for unified planning and operation will permit.

For more detailed discussions of all aspects of beacon design and use, the reader is referred to Vol. 3 of this series, *Radar Beacons*.

CHAPTER 2

NONRADAR NAVIGATIONAL METHODS

BY J. H. BUCK AND J. A. PIERCE

2.1. Nonradar Navigational Methods.¹—Because most of the non-radar navigational methods described in this chapter are available for both marine and air navigation, our discussion includes examples of both applications. These methods include visual pilotage, radio ranges, aircraft and ship direction finders, ground or shore direction finders, celestial navigation, and hyperbolic systems. In general, the sections immediately following will be confined to a description and evaluation of the above methods of navigation. Discussion of methods used with aircraft is limited to the point at which the aircraft enters the airport approach pattern. There is no discussion of methods used with marine traffic within the harbor.

It should be noted that, although the systems are discussed under their commonly used names, some of these names are not very descriptive. The American radio range and the German radio range (Sonne), for example, do not give the distance of the observer from the signal, but azimuth data only. Similarly, although the omnidirectional beacon's name implies range data, it actually gives only azimuth data.

2.2. Radio Ranges. *Description.*—The simplest form of radio range consists of two pairs of vertical transmitting antennas set at opposite corners of a square. The field pattern of each of these pairs is a figure 8, with the pattern of one pair displaced 90° from the other. A transmitter is switched from one pair to the other to transmit an *N* (dah-dit) on one pair and an *A* (dit-dah) on the other. These signals are overlapped in time so that along the bisector of the two figure-8 patterns, where the intensity of the signal received from both pairs will be equal, a continuous or on-course signal is heard over a region with a width of about 3°. These field patterns and courses are shown in Fig. 2-1. The on-course legs of the beam need not be at right angles to each other; by appropriate tuning of the antennas, they may be directed at various angles in order to lie along the airway. These directional patterns are transmitted on continuous waves, CW, in a frequency band between 200 and 400 kc/sec. Midway between the two pairs of towers just described

¹ Sections 2-1 to 2-7 by J. H. Buck.

is a fifth tower transmitting CW continuously on a frequency differing by 1020 cps from that of the directional transmitter and radiating equally in all directions. Consequently, the dit-dah dah-dit, or on-course, signal is heard in the receiver as a 1020-cycle tone. An inverted cone in which there is no signal, called "the cone of silence," exists immediately over the station.

Transmission of the dit-dah dah-dit sequence is interrupted periodically for station identification. The transmitter of the center tower may be voice-modulated for transmission of weather or traffic control information. The modulation system includes a filter to remove a narrow band of frequencies centered about 1020 cycles. The aircraft receiver has two filters, either of which may be put in the circuit. One of these, for use with the radio range only, passes only 1020 cycles; the voice broadcasts are thus suppressed. The other attenuates 1020 cycles when the voice broadcasts only are needed.¹

Navigation by Means of a Single Radio Range.—Consider the navigational information that is available from a radio-range station. A pilot flying on a known on-course signal, commonly called a leg of the beam, has continuous indication of line of position. Unless he uses means other than listening to this one radio-range station, he has a fix only over the station as indicated by the cone of silence. If, for one reason or another, a pilot does not know his position and finds himself in an A or an N quadrant, the procedure for determining which of the two quadrants he is in, or what leg of the range he first intersects, is difficult. It is also time-consuming if he uses nothing but the radio range and his compass. A positive orientation can always be made; the farther away the pilot is from the station, however, the longer it takes. Details of such an orientation procedure can be found in the *CAA Handbook of Air Navigation*. In general, the radio-range station is located in the vicinity of an airport and, when used with the altimeter, compass, and watch, provides enough directional information to put the aircraft into the holding and approach patterns.

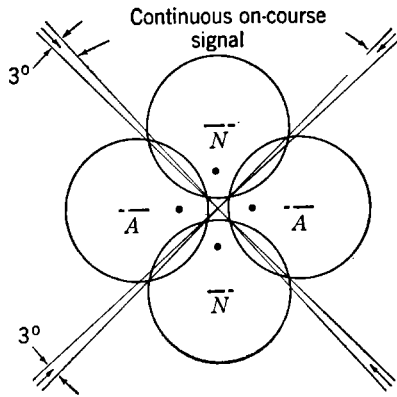

FIG. 2-1.—On-course pattern for radio range.

¹ An excellent presentation of radio ranges and allied subjects is given in P. C. Sandretto, *Principles of Aeronautical Radio Engineering*, McGraw-Hill, New York, 1942.

Aids to Radio-range Navigation.—Other devices are available as aids to radio-range navigation. In many parts of the world, fixes may be obtained not only at the cone of silence but also at the intersections of legs of two or more radio ranges. Because accurate flying is required to hit the cone of silence, particularly at low altitudes, a cone-of-silence marker is often provided. This marker consists of a transmitter operating on 75 Mc/sec with a highly directional inverted-cone radiation pattern directly over the radio-range station. For convenience, the airborne receiver on 75 Mc/sec is usually so designed that a light turns on as the airplane passes over the station. Somewhat similar marker stations with a fan pattern are located 10 to 15 miles out from the radio-range station on each leg of the beam to give the pilot an additional fix and to warn him of his proximity to the station. These fan markers are also used half-way between radio-range stations along an airway to provide an additional fix and to warn the pilot to retune to the range station he is approaching.

An extremely valuable aid to radio-range navigation is the radio compass, usually in the form of the automatic direction finder, ADF, described in Sec. 2-5. When tuned to a radio station in the 200- to 1500-kc/sec band, the ADF indicator gives directly the bearing of the station to which the receiver is tuned.

It may be used in a variety of ways. When an aircraft is flying along a radio range, the ADF may be tuned to a station off the range leg; the bearing of the station, together with the line of position known from the range leg, is used to determine a fix. The ADF may be kept tuned to the radio range being followed and, by swinging 180°, will show when the airplane has passed over the range station. When a pilot is lost in the middle of an *A* or *N* quadrant, the ADF will give the bearing of the range station, immediately identify the quadrant, and check the identity of the range leg that is first intersected.

Advantages and Limitations.—The advantages of radio-range navigation may be summed up as follows:

1. The existing stations include a network of some 200 in the United States and a considerable number in other parts of the world.
2. Since pilot training and practice have concentrated for many years on making this system the background of air navigation in the United States, there are a large number of pilots expert in its use.
3. The simplicity of airborne equipment, necessitating only a 200- to 400-kc/sec receiving set, is such that maintenance is no problem, and spare receivers are always available.
4. Reliability of ground stations is high as a result of years of experience with them.

5. Voice communication as well as course information is available with the existing system.

The limitations of radio-range navigation include the following:

1. Only occasionally are fixes available; therefore, a pilot is not certain of his position at all times.
2. Collision hazard is increased by this uncertainty of position.
3. Multiple on-course signals exist, particularly in mountainous terrain. In such regions, if an airplane flies at right angles to a range leg, it may go through several on-course signals, with or without a change of quadrant signal between them. Under these conditions it is impossible for a pilot without experience on that particular range leg to know which is the correct on-course signal to line up on and follow. The newer 125-Mc/sec ranges now being tried out eliminate much of this difficulty, however.
4. Bending and swinging of the on-course path, caused by changes of transmission conditions at the transmitter or along the propagation path, occur with some ranges.
5. The distance to which a range station can be heard and its courses interpreted varies greatly. This depends both on the location of the transmitter and on existing atmospheric conditions. In general, the high-power radio-range transmitters are located along the airways about 200 miles or less apart; this spacing is adequate for normal conditions.
6. Rain and snow static sometimes limit seriously the distance over which a radio range is usable, and may even reduce reception to as little as 20 miles. This condition can be partially overcome by various static eliminators on the aircraft or by using a shielded loop for reception. It is sometimes necessary to reduce the speed of the aircraft greatly in order to lessen the difficulties caused by static.

2-3. German Radio Range, Sonne.—During the early part of the war the Germans developed and used a navigational aid known as “Elektra” which was later improved and renamed “Sonne.” This system is essentially an omnidirectional range with multiple ambiguity and operates at a frequency of about 300 kc/sec.

The transmitter for the system radiates a multilobe pattern from three antennas, *A*, *B*, and *C*, placed in a straight line. The central antenna *B* is placed so that *AB* equals *BC*; the distance between each radiator line may be 2 or more wavelengths. By phase switching and phase shifting, certain equisignal lines relative to the station are defined, and the operator locates himself relative to these equisignal lines.

Although a variety of antenna-phasing arrangements are possible,

only the one most commonly used by the Germans will be discussed. This system places the antennas as described above, with the distances AB and BC equal to 3 wavelengths. With this antenna arrangement, A and C usually carry equal currents, which are one-fourth the current of B .

The phasing cycle may be described briefly in the following manner. If the A current is used as a reference, then at the start of a phasing cycle the C current has a phase of 180° while B is at $+90^\circ$. At the end of $\frac{1}{8}$ sec the phases of A and C are suddenly reversed. After an additional $\frac{1}{8}$ sec the phases of A and C are suddenly returned to their initial position. This phase-keying sequence is repeated at 1-sec intervals throughout the 1-min phase-shifting period. At the same time the phases of A and C are moved slowly and uniformly in opposite directions at such a rate that after 60 sec each will have changed by 180° and thus will have reversed their original values. At the beginning of the next phase-shifting cycle the phases start again at their original angles. The complete sequence of events goes through a two-minute cycle as follows:

1. Phase shifting and phase keying as above 60 sec
2. Silent period (no transmission)..... 1 sec
3. Steady transmission from center antenna only, including identification signal.....56 sec
4. Silent period..... 3 sec

With an antenna spacing of 3 wavelengths and with the described phasing conditions, the pattern at the start of a phase-shifting cycle is shown by the solid lines of Fig. 2-2. If the phases of A and C are reversed, the pattern shifts to that shown by the dotted lines. It will be seen that the maxima of one pattern occur at the minima of the other. The patterns are symmetrical about the line of the antennas but not about a line perpendicular to it.

If the phases were merely reversed without the superposition of the slow phase change, an observer on OR (Fig. 2-2) would always be at a continuous or equisignal point, an observer along OP would hear a series of pulses $\frac{1}{8}$ sec long (dots), and an observer on OQ would hear pulses $\frac{3}{8}$ sec long (dashes). This is essentially the Elektra system used by the Germans in 1940 and 1941.

If now we add the slow phase shift to the patterns, we effectively rotate the equisignal lines. Those in the top half of the pattern move clockwise and those in the lower half move counterclockwise. As a result, at the end of the 60-sec phase-shifting period each equisignal line occupies the position previously occupied by the adjacent equisignal line to the right. At the left side of the dash pattern the small lobe expands and divides, and at the right side the two large lobes contract

into one small lobe. Corresponding changes take place in the dot pattern so that at the end of the 60-sec period the two patterns have become interchanged.

As a result of these pattern changes, an observer on line OP will hear the following sequence of signals:

1. At the start of the cycle dashes will be heard.
2. As dots become audible and increase in intensity, dashes decrease in intensity until the contrast is lost.
3. This equisignal condition gives way to dots, and dots only are heard until the end of a 60-sec period.

In practice, a navigator might effectively count 35 dots preceding the equisignal period and 25 dashes following it. The fact that dots are heard first places him in a dot sector, and the fact that 35 dots are heard

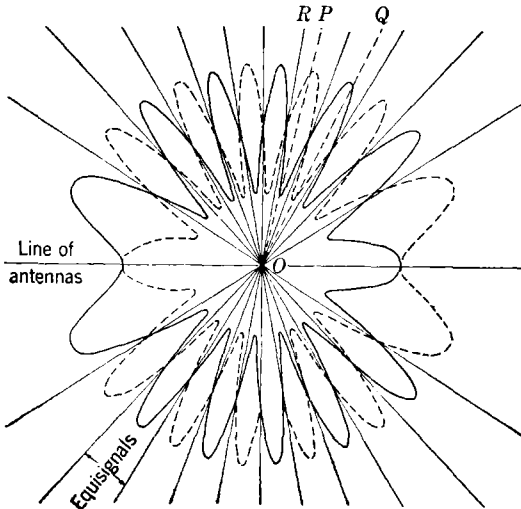

FIG. 2-2.—Dot and dash patterns superimposed. (Courtesy of Cruft Laboratory, Harvard University, and OSRD.)

enables him to find his azimuth position on a chart supplied with the equipment. Obviously there are many ambiguities because the above counts could be obtained in any of the dot sectors shown in Fig. 2-2. This makes it necessary for the operator to establish his position to within about 20° by some other means before his Sonne reading is completely unambiguous.

Under ideal conditions, the system is said to give an accuracy of 1.7° in the daytime, 2.3° at night. Ranges of 2000 miles over water are claimed; about one-half this range is possible over land.

Sonne has two very obvious advantages over the American radio range. First, it gives line-of-position data throughout 360°; second, use of two or more Sonne stations establishes a definite fix. Sonne itself requires only a radio receiver; a good direction finder should be used to resolve its ambiguities.

The system has the usual disadvantages of uncertain operation in bad weather; errors have been noted at sunrise and sunset. In addition, because the complete phase-shifting cycle takes 2 min, readings cannot be made more frequently than this.

2.4. Ultra-high-frequency, uhf, Navigational Aids.—Apart from the serious traffic problems involved, most of the faults of the present radio range can theoretically be corrected by the use of higher frequencies. The Civil Aeronautics Authorities and other organizations have been active in this field for some time and several uhf aids have been experimentally tested. These systems include the uhf range, the visual two-course range, and the so-called omnidirectional beacon.

The Uhf Range.—The uhf range¹ differs from the standard radio range only in its operating frequency, which is 125 Mc/sec. The present experimental systems use five Alford loop antennas so phased and modulated as to produce the usual *AN* pattern. The coplanar antenna array is housed in a wooden structure mounted on a steel tower some 30 ft high, and the directions of the courses are changed by rotating the whole array.

Because the normal figure-8 pattern gives a weaker signal (about 2.5 db less than the maximum) near the on-course position than between courses, the uhf range system uses a modified pattern which directs the maximum energy near the equisignal courses. This pattern has been found to be more efficient than the low-frequency range patterns. Although use of the uhf range arrangement should reduce the terrain and beam-swinging errors of the present system, it has no other particular advantage.

The Visual Two-course Range.—The use of the two-course range as a navigational aid received fresh impetus with the development of the "localizer and glide path" system for instrument landing (see Chap. 7). The localizer signal beyond the range of the glide path is merely a visual indication of direction. The pilot receives right-left indications from a meter on his instrument panel. The ambiguity present in this simple system—although it is unimportant in the actual landing problem—is removed by adding similar equipment to provide a 1020-cycle note keyed differently on opposite sides of the station. The combination of visual right-left indication and an aural note enables the pilot to identify his quadrant location with respect to the station. In this respect the system has an advantage over the usual range system because it eliminates the time-consuming procedure necessary to resolve the ambiguities. The

¹ For full details see Sandretto, *op. cit.*

two-course range, however, does not solve any of the fundamental problems involved in the use of radio range.

Omnidirectional Beacons.—The uhf omnidirectional beacons that have been developed are based primarily on the low-frequency system used for marine navigation. This low-frequency system uses a rotating-loop transmitting antenna with a normal figure-8 pattern. The antenna is rotated at 1 rpm. When the loop is at such a position that the minimum signal is along a north-south line, a distinctive all-round signal is broadcast. The occurrence of this signal and the time when the minimum signal direction is toward the ship gives the bearing of the ship from the station. This results in a 180° ambiguity which is easily resolved in marine navigation by ordinary dead reckoning.

This simple procedure has been developed for both marine and air navigation into a system using a rotating cardioid pattern which has only one minimum and therefore no ambiguity. As before, a distinctive tone is broadcast when the minimum signal is directly north of the station. In both systems the necessary equipment consists only of an ordinary radio receiver and a stop watch. Either version, therefore, is satisfactory for small ships and airplanes which can carry only limited equipment.

The uhf omnidirectional beacon uses a system of five Alford loops to produce the required beam. The central loop is fed with 125-Mc/sec energy and is amplitude-modulated at 10 kc/sec, which in turn is frequency-modulated for communication. The other four loops are connected in diagonal pairs and fed from side-frequency generators of 125 Mc/sec \pm 60 cps. These are phased in such a way that at any point in space a 125-Mc/sec signal modulated at 60 cps will be received; the absolute time phase of the 60-cps modulation depends upon the azimuth angle of the receiver with respect to the beacon. The reference voltage necessary to determine the absolute phase is provided by the 10-kc/sec carrier.

This uhf system requires special receivers in the airplane; the actual indication is, however, reduced to an azimuth selector and a right-left zero-center meter so that fixes can be obtained quickly. In experimental trials the errors have been about $\pm 5^\circ$ compared with the theoretical accuracy of $\pm 2.8^\circ$. Its operational range is 50 miles or more for an aircraft at an altitude of 1000 ft.

2-5. Airborne and Shipborne Direction Finders.—Although airborne and shipborne direction finders are essentially the same, the advantages and disadvantages of the airborne equipment are more distinct. This section, therefore, is devoted mainly to the use of direction finders in aircraft. The procedures described apply equally well to the shipborne direction finders, except that the airborne system requires lighter equipment and its accuracy suffers from the relatively long time required to

obtain fixes. Both direction finders consist primarily of a loop antenna¹ used in conjunction with an azimuth indicator, some type of loop-rotating mechanism, and a radio receiver.

Fundamentally, the loop and its associated equipment are merely the means of detecting a radio signal and determining the direction from which it comes. If the plane of the loop is at right angles to the direction of the signal, a minimum voltage is induced. The bearing is always obtained at this null position because the rate of variation of induced voltage with loop position is much greater around this point than around the maximum signal position. The azimuth indicator shows the direction perpendicular to the plane of the loop. It therefore indicates the direction of the transmitting station when the loop is rotated for minimum signal.

If this equipment only is used, the pilot or navigator tunes his receiver to the frequency of the station that he wishes to locate and then rotates the loop until the signal reaches a minimum. It is important to note that because the loop antenna has a figure-8 pattern this indication is ambiguous; the station may be in one of two directions, 180° apart. Such "fixes" on two or more stations, however, enable the operator to eliminate this ambiguity and to determine his position. This simple equipment has, in recent years, been developed progressively into the radio compass and various types of automatic direction finders.²

Both the radio compass and the automatic direction finder have vertical antennas in addition to the loop antennas. The receiver, in each case, then, is fed by two antennas, one with a figure-8 pattern, the other with a circular pattern. If the signals from these are properly phased in azimuth a cardioid pattern which is unidirectional in its indication results.

The radio compass uses the cardioid pattern, but is operated in such a way that some of the unidirectional property of the pattern is lost. The loop is rigidly mounted with its plane at right angles to the major axis of the aircraft, and the output signal of the loop is rapidly reversed by electronic switching. As a result, the phase of the loop signal is changed by 180°. This phase change, added to the signal from the vertical antenna, has the effect of rapidly reversing the cardioid pattern. The total signal is fed to a zero-center meter and, depending on the position of the station relative to the airplane, the needle of the radio compass will deflect to the right or left. If the pilot turns the airplane to obtain zero deflection the station will be placed either directly ahead of or behind the airplane. Another simple turn can tell the pilot immediately which is the

¹ Full description of the loop antenna used can be found in Sandretto, *op. cit.*, Chap. 4.

² Sandretto, *loc. cit.*

case. The radio compass is usually used as a method of "homing" but gives no indication of distance from the station.

The radio compass is very difficult to use in a cross wind because no allowance is made for drift. If the pilot carefully keeps it centered while his airplane is being blown off course by a cross wind, he flies a curved path and eventually approaches the station approximately upwind. Such a path is a long route and requires constant adjustment if the wind is very strong.

Use of ADF.—Several types of automatic direction finders which use the radio compass as a basis have been developed. Most of these use a rotatable instead of a fixed loop, following the system patented by F. L. Mosely. In simple form the loop is rotated until the needle of the radio compass returns to zero; the loop direction at this point is indicated on a bearing indicator by means of a flexible shaft connection. Bearings on two or more such stations, of course, provide a fix. If the airplane is exactly on course on a radio-range leg, a fix can be obtained by one ADF setting.

Rather simple additions to this system make the direction finder completely automatic. As long as the receiver is tuned to the required signal, the loop, and hence the indicator, remains pointed at the station. This gives the pilot a continuous indication of his direction from this station.

Basically, any type of radio compass is simple to use; a great deal of care is required, however, if reasonable accuracy is to be obtained. Under the best conditions of smooth flight and good received signals, the errors are limited to $\pm 2^\circ$. Usually, however, they range from $\pm 3^\circ$ to $\pm 5^\circ$. The accuracy depends not only on skilled operation and steady flight but also on the accuracy of the calibration of the loop. This calibration must be done carefully for each airplane and for each position of the loop because the metal structure of the airplane varies the amount of the energy received by the loop from certain directions.

Advantages and Limitations.—The advantages of the airborne radio compass and automatic direction finder as navigational aids may be summarized as follows:

1. Because the system may be tuned to any radio station the pilot can always find a "homing" station over reasonably well-populated country.
2. The airborne equipment is simple and easy to use.

The disadvantages are as follows:

1. The system is subject to all of the bad weather faults of the radio range including reduction of range due to precipitation static.

2. Physical features of the terrain can give reflections that will cause false indications of direction.
3. Because there is no indication of distance from any one station, position fixes must be obtained by plotting bearings on appropriate maps, a task that is time-consuming and extremely awkward for a pilot.
4. Collision hazard is serious because the exact position of the aircraft is not known.

2-6. Ground Direction Finders.—This aid to navigation can be used almost equally well with marine or airborne traffic. Because of the speed involved, however, it is more difficult to use with airplanes. It is essentially the same as the airborne or shipborne direction finders except that the measurements are taken on the ground and the burden of calculation is placed on the ground station, and the navigator is given a fix by direct radio communication.

Like all other radio navigational aids, ground direction-finding was first tried at relatively low frequencies; in fact, it is still largely used at these frequencies. The United States-Canadian direction-finding stations along the Atlantic coast, for example, are nearly all on 375 kc. Similar frequencies were used in Europe, where the system was the first navigational aid used by airplanes. During the war, however, operation was very successful on 3000 to 7000 kc. Higher frequencies are being tried to eliminate the usual difficulties—static, bending, etc., at long wavelengths.

Much work has been done on ground-based equipment. The Adcock direction finder and the spaced-loop direction finder¹ eliminate most of the errors due to abnormal polarization, but successful operation still depends on the station operator's ability to take bearings quickly and accurately.

As first used, the ground direction-finding system did not coordinate the ground stations. A navigator would request a fix, and while he transmitted, two or more stations would determine the direction of his signal and report this to him with their identity. From these data and the known location of the stations the navigator could determine his position. The directions given would, of course, be the actual direction of arrival of the radio signal reaching the station over a great circle course.

This method was satisfactory for most marine traffic, because the time necessary for the calculations could be taken. With ships close to shore and airplanes approaching their bases, however, it has been found much more satisfactory to operate the ground stations in teams. The

¹ Full descriptions of those antenna systems are given in Sandretto, *op cit.*, Chap. 8.

stations in any one group report bearings to a central position where all calculations of the navigator's position can be made rapidly and accurately and transmitted to him.

During the war this latter method of ground direction-finding was used very successfully by transatlantic airplanes. Although only medium-high frequencies were used, the operators became so skilled that fixes could be transmitted very rapidly. In fact, instead of giving fixes, the stations often broadcast headings for the aircraft to fly; in bad weather they were able to guide airplanes into their final approach path. This kind of performance is unusual and depends on the use of exceptionally well-trained and experienced operators.

In many ways this system, if it is reliably operated, is the most satisfactory of all the radio navigational aids because:

1. All the measuring equipment is on the ground; calibrations are more accurate, therefore, and can be checked frequently. Calculations can also be made more quickly and more accurately in a permanent ground installation than in an airplane.
2. Studies of terrain effects and reflections from nearby objects can be made in order to eliminate or allow for errors in each station.
3. Constant monitoring assures proper operation of each station. The usual difficulties of fading, beam swinging, and bad weather static are still present, however. In addition, the traffic-handling capacity is too small for an active airport if the system is being used with aircraft.

2-7. Celestial Navigation.—Until very recently the only navigational aid available to marine traffic and to aircraft on long flights over water was celestial navigation. This aid is primarily dependent on three things:

1. Clear weather so as to see the sun or the stars.
2. An accurate sextant and the necessary charts and tables.
3. A reasonably well-trained observer.

When the above conditions are filled, the position of a ship can be found to within 1 or 2 miles. A ship, however, is a relatively steady platform for observation, and very accurate sextants can be used with the sea horizon as a reference level. On the other hand, when a ship is sailing under complete overcast, no readings are possible. Before the days of radio direction-finding, the only means of navigation under such circumstances was dead reckoning. Fortunately for marine traffic, dead reckoning is reasonably reliable because of the accuracy of speed indicators and accurate knowledge of ocean currents.

For air navigation, however, a sextant with an artificial horizon was necessary before celestial navigation could be used at all. Such a sex-

tant, using a bubble level, makes possible readings from an airplane, but accuracies are no better than ± 10 to ± 20 miles. To offset this disadvantage, the navigator of an airplane is often able to obtain readings by flying "above the weather."

Despite the obvious disadvantage of complete dependence on fair weather, celestial navigation has the advantage of simple rugged equipment and it pleases those navigators who like to feel independent of outside aid. It should be noted, however, that its accuracy is independent of location and is inadequate for aircraft about to let down through heavy clouds to a landing in dangerous terrain.

LORAN AND OTHER NAVIGATIONAL NETS

BY J. A. PIERCE

2-8. Hyperbolic Systems.—Hyperbolic navigation is achieved when synchronized signals having a known velocity of propagation are transmitted from at least three known points, and when the relative times of arrival of these signals are measured and interpreted by a navigator. The general principle of hyperbolic navigation is shown in Fig. 2-3.

The signals may be transmitted and received by any known means; at present, radio is the only mechanism which is accurate at long ranges. Various sorts of signals, ranging from continuous waves through modulated waves to pulses, may be used. Pulse transmission is preferred for many present applications because ambiguity is minimized and the power supplied to the transmitters may be kept low. Pulse transmission ordinarily requires more space in the radio spectrum (that is, greater channel width) than does continuous-wave transmission; in a pulse navigation system, however, this apparent disadvantage may be entirely illusory because a number of methods of identifying signals become available by the very use of pulses. Thus, pulsed systems permit the transmission of a large number of signals within a common radio-frequency channel without excessive confusion, but continuous-wave systems require the use of a separate radio frequency for each component to provide identification.

The hyperbolic principle is now used by only three operating systems if we include those in which the base lines are so short that each is contained within a single transmitting site. Examples of these last are the Omnidirectional Range and the German Sonne systems. Of the three hyperbolic systems, the pulse method is exemplified by two, Gee and Loran, while the continuous-wave technique is used in the Decca system.

Consider two fixed stations that transmit signals at the same instant. If a navigator receives these signals simultaneously, and if the velocity of propagation can be considered to be equal over the two paths, he knows

that his position must be somewhere along the perpendicular bisector of the line connecting the transmitting stations. If one signal arrives before the other, a measurement of the time difference identifies some

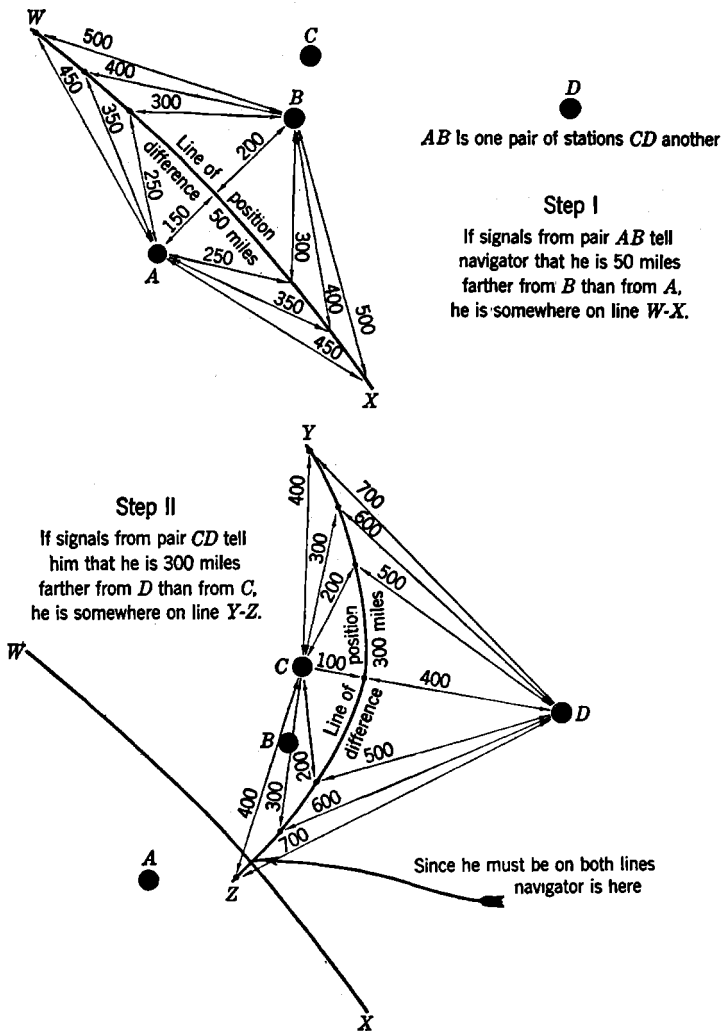

FIG. 2-3.—The principle of hyperbolic navigation.

other line of position on which the navigator must be. Although these lines of position are approximately spherical hyperbolas, they may usually be represented by plane hyperbolas drawn on a conformal conic

projection if the distances involved are not too great—less than 300 or 400 miles, for example, in the case of a system whose errors are expected to be several hundred yards.

Actually, in the pulse systems, the signals are not transmitted simultaneously but are separated by an arbitrary, constant time difference, which is introduced by causing one station to transmit some time after it has received a signal from the other. This is done partly to identify the signals and partly so that the state of the receiving equipment may be altered as required to accommodate each signal individually. The

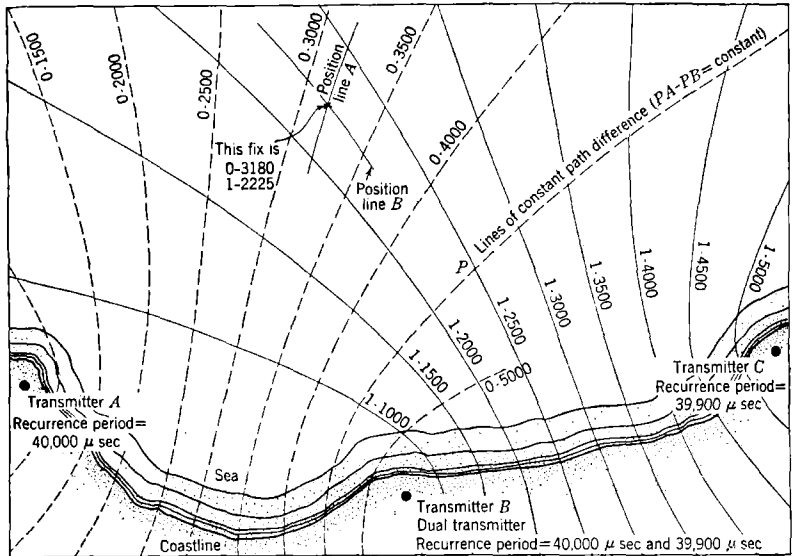

Fig. 2-4.—Loran triplet showing hyperbolic lines and method of plotting a fix. Pair *AB* provides Rate 0 (dotted) lines, and Pair *BC* provides Rate 1 (solid) lines.

signals are ordinarily repeated in an endless sequence. The measurement to be made, therefore, is actually one of relative phase rather than a time difference between single impulses although the units generally used have the dimension of time.

The navigator obtains a fix by finding his lines of position relative to two or more pairs of stations. For example, in the course shown in Fig. 2-4, the navigator obtains one position line from the pair labeled "Rate 0," while the second position line—and thus the fix—is derived from a subsequent observation on "Rate 1." These readings may be made in sequence or simultaneously, or may be continuously indicated by semi-automatic equipment. In air navigation, a few of the available position lines are usually precomputed and exhibited on special charts.

Any one line, then, may be obtained by interpolation. On surface vessels the navigator may use similar charts or may reproduce a portion of each line of position on his plotting sheet by taking the requisite data from special tables.

The number of distinguishable lines of position in the pattern surrounding a pair of stations is equal to twice the time taken for a signal to travel from one ground station to the other, divided by the smallest change in time difference which can be observed on the navigator's indicator. In Gee there are often 1000 resolvable lines for a single pair, while in Loran or Decca the number may be as high as 8000 or 10,000. Since, at considerable distances from the ground stations, the lines of position are approximately radial with an origin at the center of the base line, the positional accuracy of a hyperbolic system is about that which would be obtained with a direction-finding system capable of resolving $\frac{1}{2}^{\circ}$ to $\frac{1}{10}^{\circ}$.

The labor involved in computing these lines of position is so large that several hundred thousand man-hours have already been spent in the construction of Loran charts and tables. The results are permanently available, however, because the lines are fixed with respect to the surface of the earth. Not only is the process of taking a fix greatly expedited by this precomputation but the time spent, per navigator, decreases with increasing use of the system and becomes small compared with the computing time required for celestial navigation.

The whole process of hyperbolic navigation may be compared with that of celestial navigation since the determination of lines of position in both systems is essentially similar. The hyperbolic lines involve a more complex mathematical solution than do the circular lines obtained in celestial navigation. This additional complexity is unimportant because, as we have noted, the unchanging character of the lines permits precomputation. The hyperbolic system may therefore be thought of as equivalent to one that would be obtained if a number of stars could be permanently established above fixed points on the surface of the earth, thus providing lines of position which would immediately be known upon measurement of the stellar altitudes.

A navigator using hyperbolic navigation can determine, from charts or otherwise, the indications which obtain at some distant point—such as his destination or one of a series of points on the route to his destination—and can preset his equipment to the constants applicable at the point. His vessel can then be steered along a simple path until the predicted indications are obtained at the instant of arrival. Thus, the taking of a fix is made instantaneous at certain significant times and places; the position given is the actual one and not one occupied by the vessel at some previous time.

The great advantage of hyperbolic navigation over radar beacon systems¹ that might offer equal or greater precision over the same ranges is that saturation of the ground facilities is impossible. The transmitters of a hyperbolic system can be compared with a family of lighthouses whose keepers simply transmit intelligence as prearranged. There is no correlation between the activities of the navigators and those of the operators of the transmitters, and the behavior of the system does not depend upon whether one or ten or thousands of navigators are making use of the service it provides.

2-9. Gee.—The Gee system was the primary radio navigational aid during the European War. Its successes were far too numerous and too well known to need recounting here. The Gee system was put into operation in March 1942. Its usefulness over Germany varied somewhat with changes in types and magnitude of enemy jamming, but it served continuously as an invaluable homing system for the RAF and the American air forces, as the coverage chart in Fig. 2-5 illustrates.

Gee stations radiate about 300 kw on frequencies between 20 and 85 Mc/sec and therefore give service at somewhat more than optical ranges. Near the surface of the earth, their useful range is not over 150 miles, but their reliable service radius increases with altitude to a maximum of 450 miles. This range is attainable, in the case of fixed stations with high antennas, for aircraft at 30,000 ft. The pulses used are about 6 μ sec in length (as seen on the oscilloscope) and the method of comparison is such that time differences can be estimated to about one-tenth of the pulse length.

Base lines in the Gee system are usually about 75 miles long and are disposed with the master station in the center and the two or three "slaves" dispersed around the circumference of a rough circle. Each chain formed by such a group of stations operates on a different radio frequency. Six frequencies are available in each of the four bands assigned to the system. (This flexibility was, of course, of great value in avoiding the worst effects of enemy jamming of the British stations.)

The navigator's indicating equipment presents visually a family of four or five pulses, two being transmitted from the master station and one from each slave. A double time base (one upper and one lower trace) with a total length of 4000 μ sec is employed on the cathode-ray tube. This is shown in circle *a* of Fig. 2-6.

By the use of delay circuits, four fast cathode-ray sweeps can be initiated at such times that two of the sweeps contain and exhibit the master-station pulses and the other two exhibit two of the slave pulses in inverted form. Each of the slave pulses may be adjusted laterally to lie with its base coincident with the base of one of the master pulses.

¹ See Chap. 7.

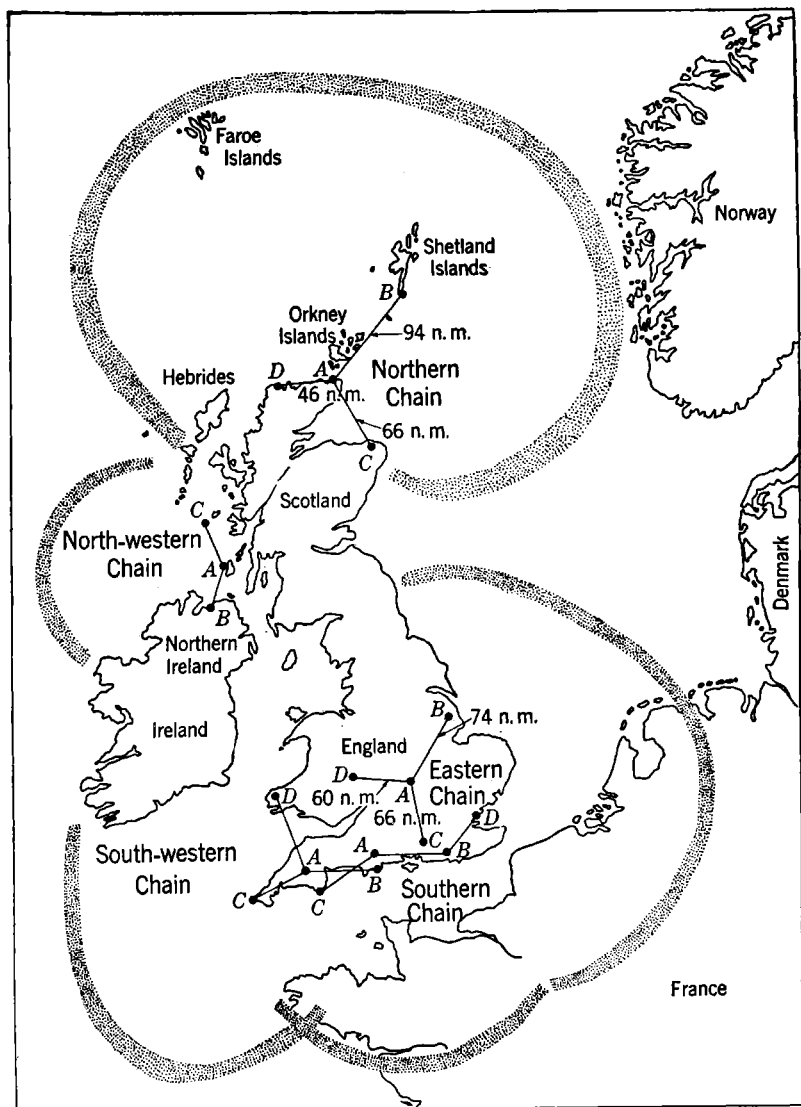

FIG. 2-5.—Gee coverage in the United Kingdom as of Nov. 1, 1945, for airplanes flying at 2000 ft or higher.

When this adjustment has been made, the two time differences (between each of the master pulses and its corresponding slave pulse) are determined from the relation between families of markers which can be switched onto the cathode-ray traces. The matching process is given in circles *a* and *b* of Fig. 2-6. The steps given in circles *c* and *d* consist of reading markers on the time bases. The most closely spaced family of

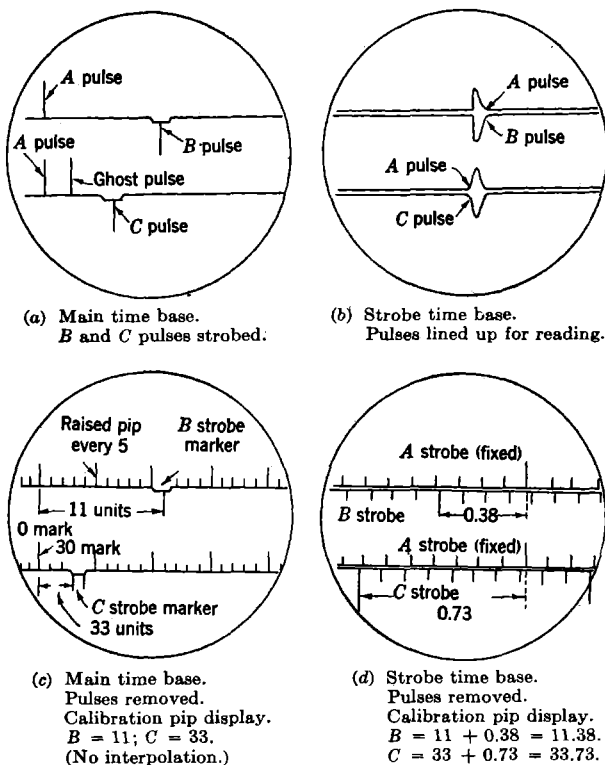

FIG. 2-6.—Gee system indication.

markers has a unit separation of $6.6 \mu\text{sec}$; interpolation to tenths permits a reading with an average error of $0.6 \mu\text{sec}$.

On the line between master and slave stations this matching and reading accuracy corresponds to a precision of about 100 yd relative to a line of position. A reading error of $0.6 \mu\text{sec}$ will correspond to a line-of-position error of somewhat more than 1 mile at the maximum distance of 450 miles, however, because the hyperbolic lines diverge approximately in proportion to the distance from the two stations. The error of fix

varies even more with distance because it is proportional to the linear errors and also varies inversely as the sine of the angle between the two lines of position. Since this quantity decreases approximately inversely with distance, the error of fix varies roughly as the square of the distance from the transmitting stations. In the Gee system, the average error in reading a time difference is about equal to the least reading ($0.6 \mu\text{sec}$); this corresponds to an average error of fix which increases from about 200 yd near the stations to about 5 miles at the maximum distance of 450 miles.

As suggested above, two lines of position can be determined at once, because two of the slave pulses can be compared simultaneously with the two master pulses. This important property of Gee makes it especially suitable for homing operations, otherwise known as "instantaneous fixing" or "navigation in advance." As mentioned in Sec. 2-8, a navigator's equipment may be preset to the constants applicable at any point, for example, at the home airport. The two pairs of pulses will not then appear in coincidence on the fast sweeps but they may usually be brought closer together by flying any course which brings the aircraft closer to the desired place. If one of the pairs of pulses comes into coincidence and is held so by flying the proper course, the aircraft then proceeds along one of the hyperbolic lines of position which passes through the airport. The rate of approach to the airport and the time of arrival there may be determined by observing the decreasing separations of the second pair of pulses and the coincidence between them. Without searching out either line of position, the Gee navigator can approach his destination by any course, knowing that simultaneous coincidence of the two pairs of pulses can be obtained only by his arrival there. Homing with Gee has been so valuable and effective in England that at the present (1945) in a system of airport approach and control around London, using a special four-station Gee chain, a landing rate of one aircraft every four minutes under bad weather conditions has been reported.

Whether Gee or Loran is used for navigation in advance or for obtaining occasional fixes to be used with dead reckoning, a most important feature of hyperbolic navigation is used to full advantage: since the hyperbolic lines are fixed with respect to the earth, all courses derived from them are true courses and all speeds are ground speeds. The effects of drift, therefore, are compensated automatically. As a result, even a tyro can navigate an aircraft with amazing ease and accuracy.

As a permanent navigation system, Gee has much to recommend it, but suffers from four limitations:

1. Because the choice of frequency yields good range only at high altitudes and results in a system with high accuracy over only a

- small area, a very large number of chains would be required to provide service over a continental region.
2. The choice of recurrence rate limits the length of the base lines that can be used, even if the frequency or synchronizing techniques should be changed, and it therefore forbids much expansion of the linear dimensions of the service area.
 3. Because only one chain of stations can be operated in $\frac{1}{2}$ -Mc/sec r-f channel, the problem of finding enough room in the radio spectrum would inhibit the operation of an extensive system.
 4. The pulses to be compared are usually of varying amplitudes; some experience and judgment, therefore, are required in making a match. This factor would probably result in either additional complication or reduced accuracy if automatic matching equipment were to be used.

2-10. Loran.—Standard Loran is a hyperbolic system that was developed primarily for navigation over water. It operates on one of several frequencies between 1700 and 2000 kc/sec and therefore enjoys propagation characteristics determined primarily by soil conductivity and ionospheric conditions. Transmitters now in use radiate about 100 kw and give a ground-wave range over sea water of about 700 nautical miles in the daytime. The daytime range over land is seldom more than 250 miles even for high-flying aircraft and is scarcely 100 miles at the surface of the earth. At night the ground-wave range over sea water is reduced to about 500 miles by the increase in atmospheric noise, but sky waves, which are almost completely absorbed by day, become effective and increase the reliable night range to about 1400 miles. The variable transmission times of the sky waves reduce somewhat the accuracy of the system. The timing errors grow smaller with increasing distance, however, and partially compensate for the increasing geometrical errors, so that navigation by sky waves compares tolerably well with celestial navigation. Except in ground-wave transmission over land, the signal strength (and therefore the usefulness of the system) does not vary at all with the altitude of the receiver. Even over land, the principal increase in signal with height occurs within the first few thousand feet; little improvement can be expected by going to higher altitudes.

Pulses shorter than about 50 μ sec cannot be used at standard Loran frequencies because of the necessity for conserving space in the radio spectrum. For this reason, as many stations as possible should be operated in a single r-f channel. The long pulse length requires the use of careful matching techniques to obtain reasonable precision. The method employed is to alter the gain of the receiver as required in order to produce pulses of equal amplitude on the oscilloscope no matter what

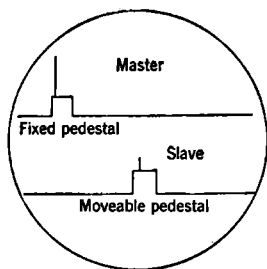

(a) Slow sweep.
Both pulses on their pedestals.

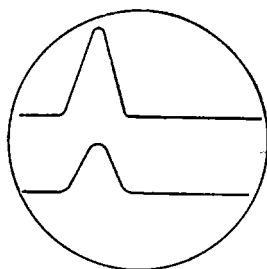

(b) Medium sweep.
Pulses aligned vertically.

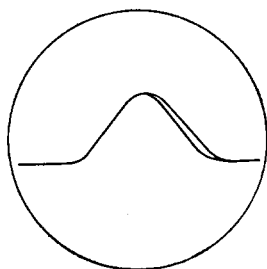

(c) Fast sweep.
Amplitude equalized, trace separation removed, pulses superimposed.

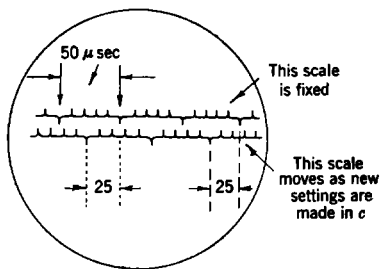

(d) Fast sweep.
Marker display.
Lower trace displaced 25 μ sec from upper trace.

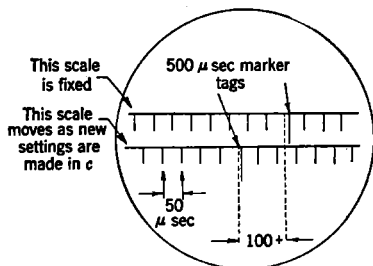

(e) Medium trace
Lower trace displacement 100 μ sec.
No interpolation.

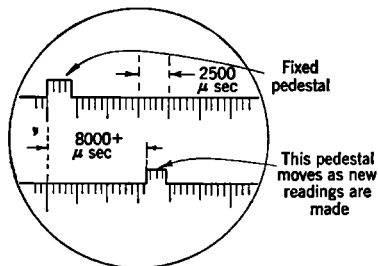

(f) Slow sweep.
Pedestals displaced 8000 μ sec (no interpolation).
Reading is $25 + 100 + 8000 = 8125$ μ sec.

FIG. 2·7.—Loran system indication.

distances or other attenuating factors may be present in the two transmission paths. The pulses may then be superimposed accurately, provided that, as radiated, they are made sufficiently identical by all transmitters. Such a measurement may be made with a precision of 1 per cent of the pulse length if the signal-to-noise ratio is satisfactory. Figure 2-7 depicts the Loran reading process. Figure 2-8 is a picture of the airborne and shipborne equipments.

The method of measurement is similar to that used in the Gee system, except that no effort is made to indicate two lines of position at once. This is a very important exception. The reason for it is somewhat involved and will be discussed below. The navigator can make readings to the nearest microsecond—two-thirds of the precision of the Gee reading. The base lines ordinarily used are about 300 miles in length so that the geometrical factors at 1400 miles are similar to those of Gee at 350 miles.

If, as is common, three Loran stations are used as a triplet, the accuracy of fix may be compared to that of Gee because the same factors apply. The average error at short distances is about 300 yd and increases smoothly throughout the ground-wave service area to a little more than 1 mile at 700 miles. At night, sky waves may be used at distances between 300 and 1400 miles with average errors ranging from 1.5 to about 8 miles.

The average errors of fix at long ranges are often smaller than these estimates because selected Loran pairs can often be found which supply better crossing angles than are obtainable from a lone triplet. Loran stations are often installed as a chain consisting of three or more stations, along a coast line or between islands. In each pair, pulses are transmitted at a specially assigned recurrence rate, one of a family that have ratios 400 to 399 to 398 and so on . . . to 393. Thus, as many as eight pairs, all employing the same r-f channel, may operate as a chain. The navigator's equipment can be adjusted to synchronize with any one of these rates to identify a particular pair. The pulses at the chosen rate *then appear stationary and their time difference can be measured.* The pulses from all other stations pass across the screen at such speeds that confusion is negligible. Stations between the ends of a chain ordinarily are "double"; that is, they act in all essentials as two independent stations at the same location, so that a chain consists of a number of separate pairs set accurately end to end.

The navigator can choose from among these the pairs he will use for determining a fix in the same way that he would choose stars for celestial navigation. In other words, he takes those whose lines of position cross at the most favorable angle. In fact, he frequently uses three- or four-line fixes for maximum precision, because the reading of a single line of

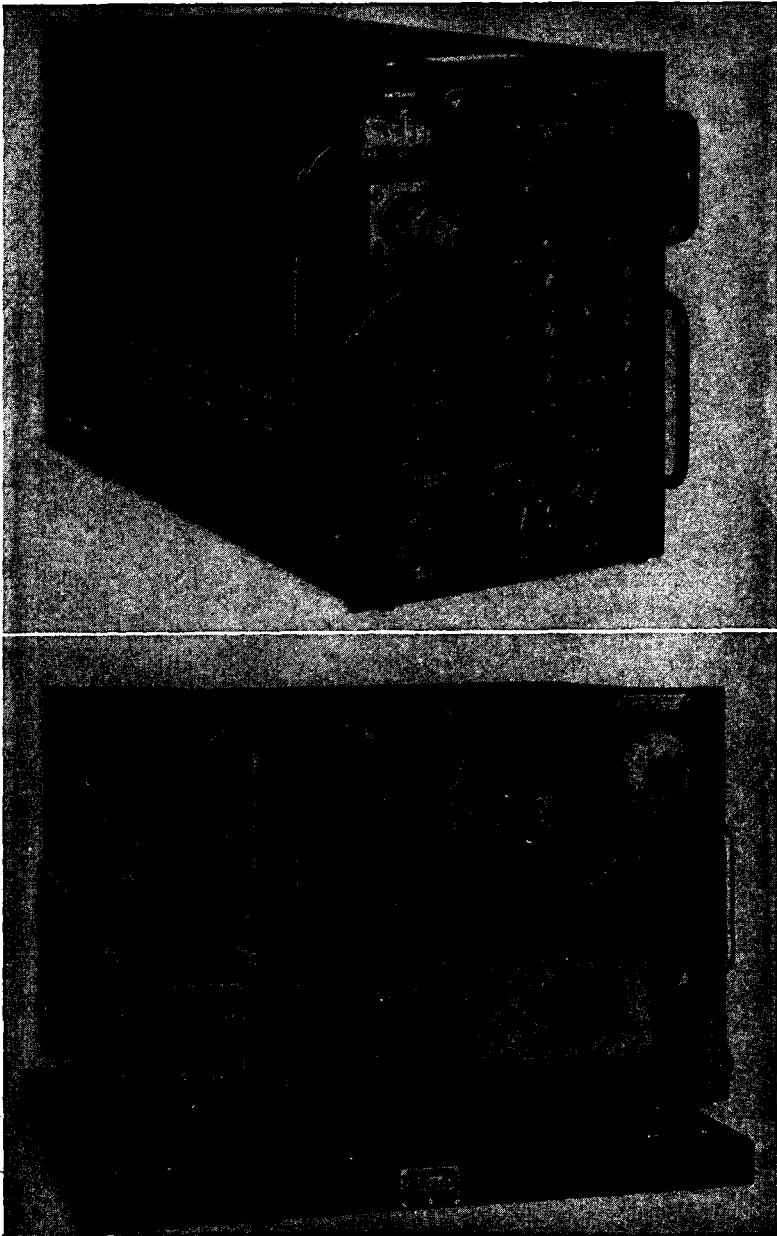

FIG. 2-8.—Loran indicators. Lightweight, airborne model above, shipborne model below.



FIG. 2-9.—An air view of a Loran station on the Faroe Islands.

position at a time permits great freedom of choice. This arrangement stems directly from the concept that Loran navigation is to be effective over an area that is large compared with that which could be served by a single pair or triplet. If a three-line fix is used, the chance that the true position is within the triangle bounded by these lines is one in four.¹

The Loran system in the North Atlantic, for example, consists of a chain of five stations along the east coast of the United States, Nova

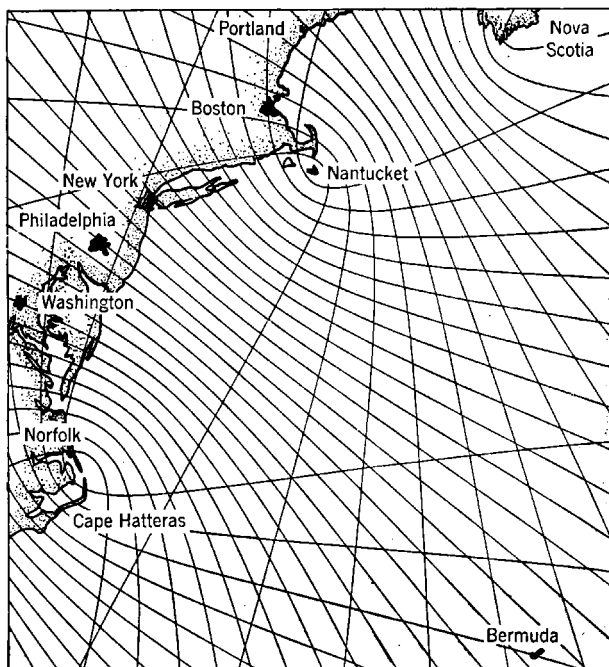

FIG. 2-10.—Section of Loran coverage, New York to Bermuda, showing the more important features of a Loran chart. Readings are ordinarily made to $\frac{1}{100}$ of the spacing of the lines in this figure. The customary microsecond labels are omitted.

Scotia and Newfoundland, a triplet between Newfoundland, Labrador, and Greenland, and a triplet extending from Iceland through the Faroes to the Hebrides. An air view of a Loran station on the Faroes is shown in Fig. 2-9. These stations form a total of eight pairs so that often a total of three, four, or five lines of position are available to the navigator. The sample Loran coverage between New York and Bermuda shown in Fig. 2-10 displays only three sets of position lines; the others have been deleted for clarity.

¹S. A. Goudsmit, "Accuracy of Position-finding Using Three or Four Lines of Position," *Navigation* (Journal of the Institute of Navigation) 1, 34 (1946).

Because pairs of Loran stations transmit at various recurrence frequencies, it would be necessary almost to double the number of components in the navigator's equipment in order to give him the advantage of simultaneous determination of two lines of position, as in the Gee system, if his freedom of choice of lines is to be maintained. It has seemed better, therefore, to reduce the complexity of the receiving equipment and to recommend the use of two complete receivers when instantaneous fixes are necessary.

With Loran equipment a fix is ordinarily taken in about three minutes, about twice the time taken with Gee. Homing to a point can be accomplished by following one line of position until the correct compass heading has been determined and then switching to a second pair of stations to determine the progress along the first line. This process is cumbersome and finds favor only with those operators who have not had experience with Gee.

The chief disadvantages of Loran are:

1. The impossibility of instantaneous fixing without dual installations.
2. The fact that the use of sky-wave transmission requires the application of corrections before the charts or tables can be entered.
3. The presence at night of long trains of pulses reflected from the ionosphere (see Fig. 2-11). In one of these trains, only the first reflected pulse is useful for navigation, but from 1 to 20 useless pulses may follow it. The difficulty of identifying the correct pulse is thus greatly increased and the useless pulses interfere with operation of other pairs in the same channel.
4. The fact that ionospheric transmission is not homogeneous with the result that the shapes of the sky-wave pulses are often distorted and difficult to match; the time of transmission, moreover, varies from hour to hour and creates minor errors that cannot be eradicated.
5. The rather embarrassing difference between the ground-wave ranges over land and over water, which inhibits the free choice of station sites in many cases and reduces the base lines for overland triplets to about the scale of Gee.

2-11. "SS" Loran.—An alternative technique for using the equipment developed for standard Loran takes advantage of the long nighttime range of E-layer transmission to extend the base line of a pair of stations to 1200 or 1300 miles. This kind of operation is known as "Skywave-Synchronized" Loran. It is effective because of the large increase in geometrical accuracy which derives from the long base line.

Because sky waves are used for transmission paths between stations and from the stations to the navigators, there is no escape from the timing

errors produced by variations in the height of the reflecting layer. The total error has an average value of about 8 μ sec for a single reading. This establishes the minimum average error of fix at about nine-tenths of a nautical mile when the navigator is at the intersection of two base lines crossing at right angles. This condition is obtained in the preferred orientation of stations—the SS Loran quadrilateral where, ideally, the stations occupy the corners of a square and the base lines are the diagonals. In this case the useful service area is nearly the area of the square—perhaps a million square miles—and nowhere does either the crossing

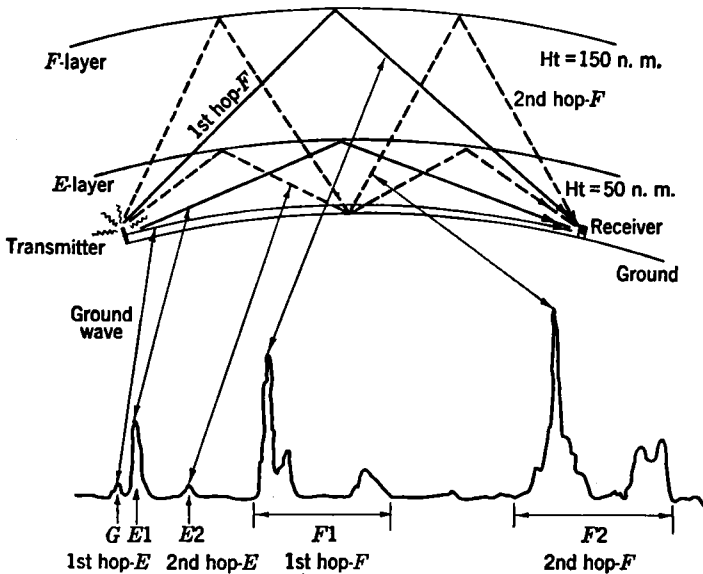

FIG. 2-11.—Signals produced by multiple paths between transmitter and receiver. Only G and E1 are used for Loran purposes. F1 is often split, as shown, and F2 follows G by 500 to 2000 μ sec depending on the range. The long and complex F pattern indicates the instability of the upper layer.

angle or the separation between hyperbolas become greatly inferior to the value at the center of the pattern. These properties of the quadrilateral are illustrated in Fig. 2-12. The distance corresponding to a change of a microsecond in the time difference may degenerate from 500 to 800 ft, and the crossing angle may change from 90° to 60° at the outer edges of the service area, but these variations increase the average error only from 0.9 to about 1.7 miles. Unfortunately, the transmission times may make unpredictable excursions, especially during ionospheric storms, but the maximum errors of fix seem to be about 5 or 6 miles and to occur not more than about 1 per cent of the time. The serviceability of the system, or the fraction of the night hours within which satisfactory synchronization can be maintained, is remarkably high, about 99.8 per cent except

where the points of reflection are close to, or in, the auroral zone. A facsimile of an SS Loran chart employed by the RAF in night raids over Germany is shown in Fig. 2-13. This organization conducted about 22,000 sorties with SS Loran in the six months preceding the close of the European phase of World War II, and the average error of fix was reported

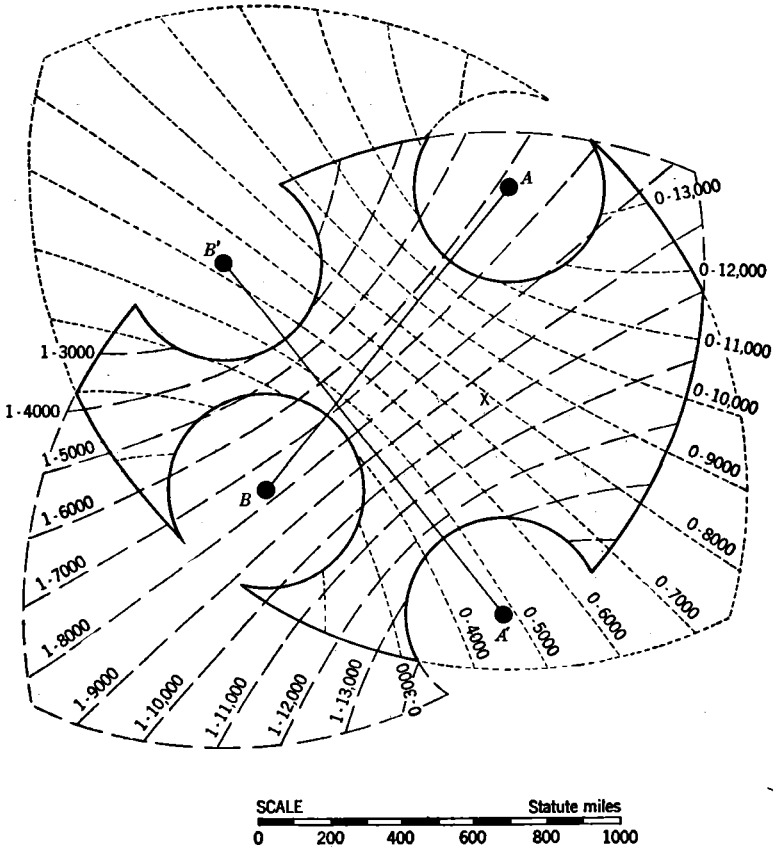

FIG. 2-12.—An SS Loran quadrilateral. The solid line bounds the region common to transmitter pairs AB and $A'B'$. Indicator readings at X are 7500 on Rate 0 and 9700 on Rate 1.

to be less than 2 miles. This figure was comparable to or better than that of certain radar blind-bombing aids.

2-12. Low-frequency Loran.—Another variant of Loran under development takes advantage of the increased range of propagation at low radio frequencies. This LF Loran system will probably offer a daytime range about equal to the nocturnal range of standard Loran and will permit base lines two or three times as long as those now in use. Its greatest single advantage seems to be a tremendous improvement in

range over land at low frequencies—an increase which gives promise of a system with at least a 1000-mile range over land or sea, by day or by night. A service radius of 1500 miles was obtained over land in a trial system in the United States, but this range depends upon daytime sky-wave transmission which is not yet fully understood and which may well be undependable in the summer in some latitudes.

The timing accuracy of LF Loran is not equal to that of standard Loran, primarily because it is necessary, for technical reasons and also

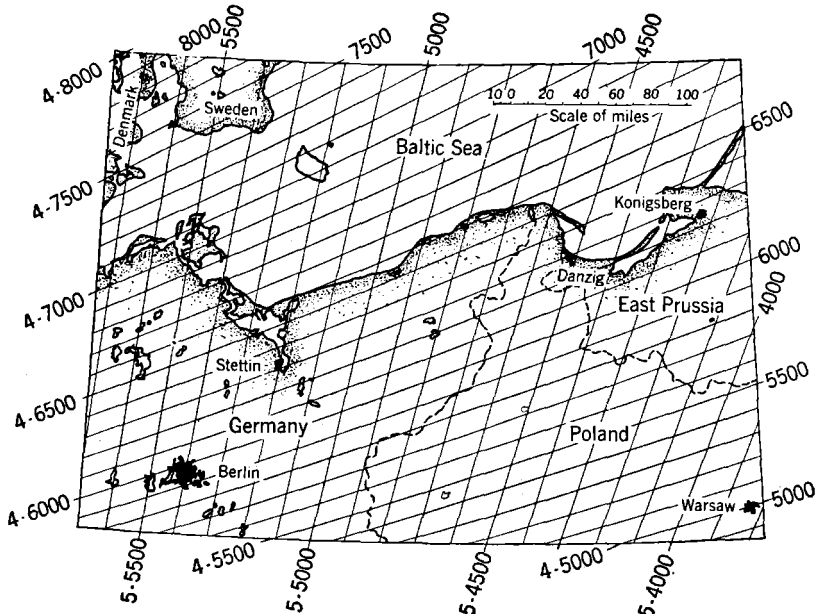

FIG. 2-13.—A section of an SS Loran chart used by the RAF from 1944 to 1945. Labels are in microseconds as read by the navigator. (Courtesy of the British Air Ministry.)

because of the limited available spectrum, to operate with a narrower channel and correspondingly longer pulses. The pulse length is about $300 \mu\text{sec}$ and the average reading error at short distances seems to be about $4 \mu\text{sec}$, four times that of standard Loran. During trials performed in 1945, some eighty thousand individual observations were made at fixed monitor stations of LF Loran transmissions from the east coast of the United States. With a base line of 600 nautical miles, the average position-line error in these observations as a function of distance is given in Table 2-1. These data refer to a position line that subtends a 45° angle with the base line, a fairly typical case.

TABLE 2-1.—AVERAGE POSITION-LINE ERROR. LF LORAN READING, 1945
All figures in nautical miles

Distance	Av. error, summer, day	Av. error, summer, night
500	±3	± 3
1000	±3	± 4
1500	±4	± 7
2000	±6	±16

A very great advantage of LF Loran is that, since the r-f energy never penetrates beyond the E-layer of the ionosphere, the long trains of night-time sky waves (which make identification difficult at 2 Mc/sec) are not present in 200-kc/sec transmission. Because of the long pulse length, the various orders of E-layer reflections overlap the ground wave. As a result, most of the energy arrives in a single pulse. Thus, ambiguity is avoided to a degree which permits the use of more complex and more useful schemes of station synchronization than in standard Loran.

The first step toward more versatile Loran systems is the operation of three stations at a common recurrence rate, as in the Gee system. If two slave stations are synchronized with a common master station midway between them, the slaves themselves are then synchronized with each other, since the base line connecting the slave stations is twice either of the other two base lines, and slave-slave hyperbolas diverge only about half as much as those associated with the master station. Thus, the three stations generate three families of hyperbolas and the "extra" family has important properties which provide greater accuracy at long distances as well as nearly straight lines of position in the center of the coverage pattern.

Another interesting orientation of stations is the quadrilateral in which four stations occupy approximately the corners of a square. If the four stations operate on the same recurrence rate, any one of them may be the master while those at either side are normal slave stations. The fourth station may be a secondary slave operating against either of the other two slaves. In this arrangement, six families of hyperbolas are available. The two of greatest interest are those that are erected upon the diagonal base lines and provide crossing angles of 60° to 90° over the whole area of the square. An advantageous feature is that the diagonal geometrical base lines are 1.4 times the length of the synchronization paths; this additional length provides double the service area of a quadrilateral system of two independent pairs, since transmission and noise conditions always determine the maximum separation of a synchronized pair.

Other more complex groupings of stations are possible and may even-

tually become useful. All of these arrangements involving the use of more than two pulses on a common recurrence rate require that one or more of the pulses be identified by a peculiar shape or in some other way, but numerous identification methods can be used to avoid undue confusion. The method employed in the triplet under trial in 1945 was to vibrate one of the pulses slightly in phase with the result that, in addition to a steady pulse used for measurement, there appeared an "ident" pulse to the right of the steady pulse. In Fig. 2-14 this vibrated pulse

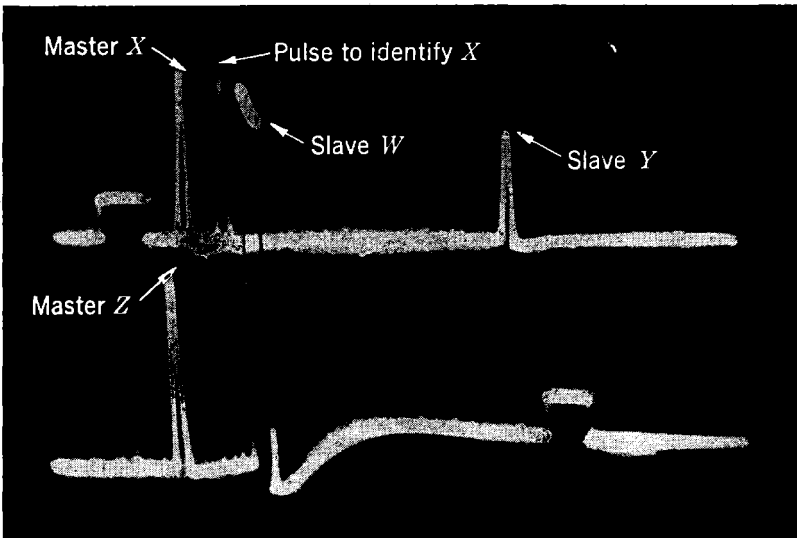

FIG. 2-14.—An LF Loran indication showing pulses from 3 stations of a triplet. Conventional Loran readings are made between X and W , Z and W , and W and Y . Station W is close to the receiver and therefore produces a strong signal. X and Z originate at the same station.

appears on the top trace. The top and bottom traces form one continuous sweep.

More than two pulses on a common rate would permit the easy use of instantaneous fixing as in the Gee system, but this feature will have to await the construction of new and improved Loran indicators. The immediate steps taken to add low-frequency service to Loran assumed the use of existing receiver-indicators plus a simple frequency converter to change the low frequency to that at which the existing equipment operated. The converters were designed for extremely simple installation and operation so that low-frequency service could be provided without requiring any extensive additional training of operators and navigators.

Low-frequency transmitting stations are more complex than standard Loran and require new construction, except for most of the timing ele-

ments, but there are so few of them that the total effort required to add low-frequency operation to the present Loran system is entirely within reason.

A version of LF Loran which may become extremely important, at least for certain applications, is called "cycle matching"; it consists of comparing the phase of the r-f or i-f cycles of a pair of pulses rather than of comparing the envelopes of the two pulses. Equipment for this technique is still in such an early stage of laboratory development that a critical evaluation is not yet possible; it seems reasonable, however, to expect that measurements may be made to 0.1 μ sec over ground-wave ranges. The facility with which such readings can be taken is as yet unknown, but it is probably safe to predict that after a difficult development program cycle matching can provide accuracies equal to those of H-systems, at ranges of 600 to 800 miles. Preliminary tests in August 1945 gave an average position-line error of 160 ft for observations on stations 750 miles distant.

2-13. Decca.—Decca is the name commonly applied to a low-frequency continuous-wave hyperbolic system, officially designated "QM," that has been under test and operation by the British Admiralty for some years. As in other hyperbolic systems, at least three stations (two pairs) are necessary to provide fixing cover. The master station transmits at the basic radio frequency of the system while the slave in each pair radiates at a different radio frequency simply related to that of the master, the ratio being 3 to 2, or 4 to 3, etc. Each slave monitors the master, maintaining its own emissions at its assigned frequency but with phase rigidly related to that of the master. The family of hyperbolic lines thus are lines of constant phase difference.

The navigator's equipment consists of a receiver channel for each station (three in all for fixing), suitable multiplying and phase-comparing circuits, and two phase-indicating meters (similar to watt-hour meters). Let us assume the master frequency to be 90 kc/sec, that of one slave to be 120 kc/sec and that of the other slave to be 135 kc/sec. The equipment, by means of frequency multipliers, changes the frequencies of the master and first slave to the common multiple of 360 kc/sec, and displays the phase difference on the indicating meter; this furnishes information on one line of position.

For the second slave and second line of position the phase difference is examined at a frequency of 270 kc/sec. The operation is wholly differential; the coordinates of the point of departure must be set into the equipment manually at the beginning of every continuous run. A constant phase reading indicates that a hyperbolic course is being followed, and changes of phase may be summed up when cutting across hyperbolic "lanes." The wavelengths used are about a mile or greater. The read-

ing precision has been quoted variously from $\frac{1}{1000}$ of a wavelength to $\frac{1}{30}$ of a wavelength.

The Decca system in its present form is highly ambiguous because there can be no identification of a cycle. Therefore, although a great many lines of position are available to the navigator, successful interpretation of the data obtained depends upon two factors. First, the point of departure of the vessel must be known, and second, the equipment must be operated continuously. Ambiguity can be reduced as far as desired by modulating the radio frequency with a lower envelope frequency that gives coarser identification of the hyperbolic lines. This technique apparently makes the receiving equipment prohibitively complex.

Decca has two other defects that militate against its extensive use. One is its somewhat extravagant use of the radio spectrum. Because a different frequency is required for each station, the number of frequencies required to cover a large area would be prohibitive. A pulsed system covering an equal area would utilize only one spot in the spectrum and require a smaller net channel width.

The second, and more serious, defect of Decca is that interfering continuous waves can distort the readings almost without limit without the navigator's being aware of it. An extreme example is the interference produced by sky-wave transmission, which is often present at the frequencies employed for Decca. It prevents the use of base lines more than 100 miles long, and limits the useful service radius to perhaps as little as 200 miles.

2-14. Accuracy and Range of Various Systems.—A consideration of the factors which affect the timing accuracy of pulsed systems indicates that a Loran system (a system in which the pulses are equalized and superimposed) ideally should yield matches which are accurate to about half a wavelength. This accuracy corresponds to a minimum error of line of position of a quarter wavelength, or 125 ft at the frequency used for standard Loran. Actually, the minimum error in standard Loran is about 500 ft; this increase is due partly to the use of pulses about twice the minimum size and partly to the use of reading techniques that are not as precise as could be desired.

The accuracy of Loran in the ground-wave service area could no doubt be quadrupled by the use of shorter pulses and indicators with more stable circuits and more closely spaced families of marker pips. These changes, however, would not enhance the sky-wave service, which contributes a large part of the usefulness of the system, because in that case the accuracy is controlled by propagational variations that seldom permit an average error of less than $2 \mu\text{sec}$, which is twice the current reading error.

Gee pulses are not equalized in amplitude or superimposed. A measurement, therefore, is good only to about one tenth of the pulse length. In the Gee system, the practical average error is about 100 yd; the "theoretical" error is about one fourth as great, or even less at the higher frequencies. As in Loran, the departure from the optimum is accounted for partly by the use of long pulses to reduce the spectrum space required and partly by a certain crudity in the indicating equipment for the sake of simplicity.

For LF Loran the same analysis leads to an estimate of average errors of a quarter mile in the best areas. Although this figure may actually be attained now at short distances, propagational factors as well as geometrical ones will probably operate to increase these errors over a large part of the service area.

For Decca or other phase-comparison systems, it seems reasonable that a precision of 1° of phase should be attained, although neither Decca nor cycle-matching LF Loran have yet reached that accuracy in practice. Even the present precision of about 1 per cent of a wavelength, however, is extremely interesting in comparison with pulse envelope methods.

Transmission ranges and service areas also depend primarily on frequency, and the lower the frequency the better. The reliable range throughout the microwave region is little more than the optical range. Even the ranges obtained in the uhf band are not more than about one and one-half times the optical range. This often results in good cover for high-flying aircraft, as in the Gee system, but the distances usable at the surface of the earth are discouraging from the point of view of navigation.

As the frequencies decrease through the high- and medium-frequency regions, ground-wave ranges increase and the differential in signal strength observed at high and low altitudes grows smaller, especially over sea water. The propagation of signals as the frequency is decreased is no longer simple because of the complex structures of multiple sky-wave reflections that vary tremendously with the time of day. Furthermore, at the higher frequencies the behavior of sky-wave reflections is extremely unpredictable.

These sky-wave phenomena become simpler and more predictable in the lower part of the medium-frequency range, but only at low frequencies is there such a degree of stability that sky waves can be used without confusion. At very low frequencies, propagation over thousands of miles is easy and reliable, but wide-band antenna systems are not available because the required size is prohibitive.

As long as current techniques prevail, therefore, pulse methods cannot be expected to operate at these frequencies. At present it seems that 100 to 150 kc/sec is about the lower limit for pulse systems. At these fre-

quencies ranges of 1500 miles should be easily obtained over land or sea and at any altitude. Either pulse or continuous-wave systems may be used at these frequencies, although the pulse systems will require larger and more expensive antenna structures. If reliable ranges greater than about 1500 miles are needed, continuous-wave systems operating at very low frequencies must be used. The alternative is to use pulse systems with very long pulses and relatively low accuracy.

All of these considerations lead to the conclusion that there are, theoretically, two infinite families of hyperbolic navigation systems, the pulsed and the continuous-wave methods, and that for each method the choice of frequency establishes the desired compromise between range and accuracy. Continuous-wave systems have inherently greater precision but are so ambiguous that they are of interest only at the low-frequency end of the spectrum. Pulse systems, on the other hand, may be useful at any radio frequencies except the very lowest, but they suffer from limited range at higher frequencies, from sky-wave interference and ambiguity at middle frequencies, and from limited accuracy at the low frequencies.

Nevertheless, the choice among the many possibilities is easy. In a permanent navigation system, the ambiguities inherent in the continuous-wave method and in pulse methods in the high-frequency range are intolerable. Therefore, the choice lies between low-frequency and uhf pulse methods. Of these, the uhf method is unsatisfactory because of its very short ranges at the surface of the earth. A secondary factor of marked economic importance is the far greater number of high-frequency stations required to cover a given area. A low-frequency Loran system, on the other hand, should give fixes to within 5 miles or so over tremendous areas and errors well under a mile in certain areas. For most purposes this accuracy is sufficient. If much greater accuracy is required there are two alternatives whose relative merits need to be investigated: cycle matching in LF Loran, and local-approach uhf chains supplementing a low-frequency general navigation system and receivable with the same equipment.

2-15. Automatic Data Analysis.—Anyone familiar with Gee or Loran equipment can readily see that it would not be difficult to perform all of the set manipulations automatically. There is no insuperable technical problem in producing a receiver which will automatically present, for example, the Loran readings on two lines of position on a pair of dial counters. During the war, however, completely automatic receivers were not needed, but when hyperbolic navigation is applied to commercial transportation a position-determining set that operates continuously will be desirable. Like the chronometer in the chart room, it will be in constant use; the navigator should be able to look at it whenever he wishes to

know his position. There are a great many ways in which such automatic sets can be built. Most of them may be so complicated, however, that the navigator would be properly skeptical of their reliability.

The most common suggestion for a device of this kind is to have an attachment to the indicator which would automatically present latitude and longitude directly to the observer. This is a natural but misguided proposal because there is little that is inherently more desirable in latitude and longitude than there is in Loran coordinates. The two things that a navigator always wants to know are the distance and direction to one or to several points.

Another suggestion is to use a black box containing a number of push buttons and a pair of visible counter mechanisms. A navigator would only have to push the button marked "Bermuda," for instance—whereupon the counters would spin and stop so that he could read "distance, 342 miles; course, 114°." Such a device, however fine a toy it might be, fails because the navigator should not be satisfied unless he is told his relation to a great many different places. Once he obtained this information, either with the black box or the latitude-longitude indicator, he would then have to plot his position on a chart before he could understand the interrelations between his position and those of all other significant points.

Obviously, the only really effective automatic aid to navigation will plot the position of the vessel continuously. It should leave a permanent track on a chart so that the navigator can see at a glance his current position in relation to all other points on the chart, and also can have the history of his voyage presented to him in graphic form.

The desirability of such an instrument will be obvious to the sales managers of our larger electronic corporations. They will probably see to it that the necessary time is spent to develop and produce a practicable device. The only prerequisites are that ground stations must be in operation to provide the necessary coverage, and that the control of the ground stations must be in responsible hands.

It is worth while here to point out a single concept which, although it violates sea-going tradition, may have some influence by virtue of its simplicity. In any Loran indicator, there is sure to be a shaft whose rotation is more or less linearly proportional to the Loran reading. This shaft may be connected to a pen through a mechanism such that the lateral position of the pen also bears a linear relation to the Loran reading. A second shaft from the same, or a second, indicator may be connected so that a rotation of that shaft in accordance with a second Loran reading produces a linear motion of the pen at an angle to the first motion. With this arrangement, any pair of Loran readings which defines a point on the surface of the earth also defines a position of the penpoint on a

plane. A sheet of paper over which the pen moves is therefore a chart drawn in Loran coordinates.

This simple system has one defect. It considers that all Loran lines in any family are straight and parallel, and also that the angles of intersection between the lines of any two families are constant all over the chart.

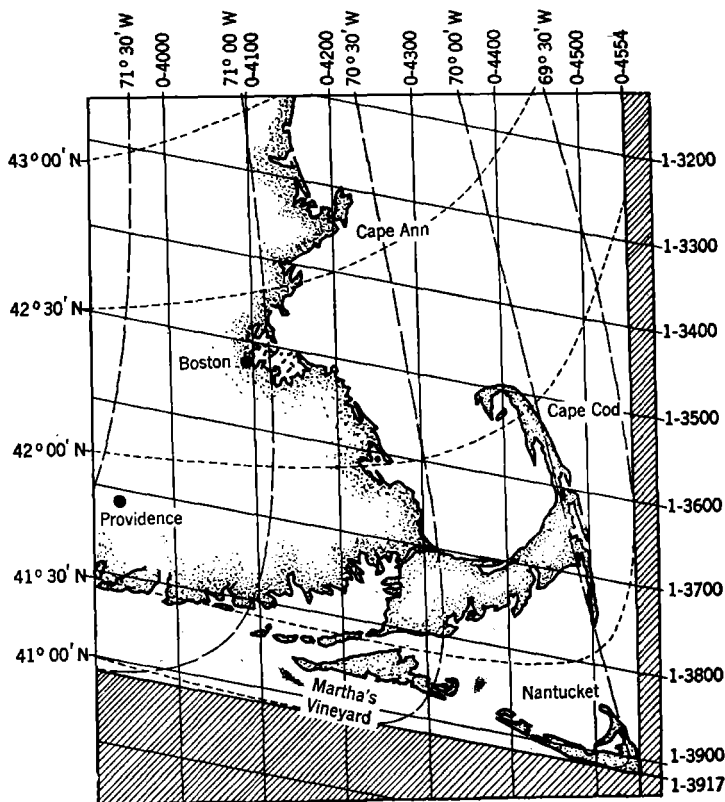

FIG. 2-15.—Loran plotting-board chart with Loran projection. The map is drawn assuming that Loran position lines are straight and parallel. This example exhibits the worst possible distortion since the area shown includes a Loran station.

These limitations, however, may not be too severe, especially in an area at some distance from the ground stations. The angle between the two directions of motion of the pen may be set at the mean value of the crossing angle of the Loran lines in the area. Likewise, the rates of motion in the two directions may be set to be proportional to the relative separations of the lines in each family.

This plotting-board concept has the immense advantage of mechani-

cal and electrical simplicity. In many cases, if the area on a chart is not too great and if the ground stations themselves are not in the charted area, the distortions encountered in drawing such a chart in Loran coordinates are no greater than those involved in many other projections.

Experiments were conducted with SS Loran using a plotting board of this sort. An ordinary Lambert chart was used to cover an area whose side was 150 miles, about a sixth of the length of the base lines, and the Loran lines were sufficiently straight and uniform to ensure that the errors due to the assumptions mentioned above were no larger than the errors inherent in SS Loran. The presentation described in the last paragraph was also tried and flown for standard Loran, with good results. A section of the Loran projection so used is given in Fig. 2-15.

2-16. Automatic Piloting.—Mentally it is only a very short step, and mechanically not a long one, from automatic presentation of position on a map to connecting the map and the rudder of a vessel so that a pre-determined track may be followed automatically. The means are easy to visualize and are already at hand. Only incentive and time are required; here, again, commercial enterprise may be relied upon to bring a family of such devices into being.

One variant from past experience with direction-finding must be pointed out. When a direction-finding system is used, any change of course is immediately indicated and measured so that a correction may be made instantaneously if the change is accidental. When a hyperbolic system is used, however, a change of course does not lead to any change of indication until after the new course has been held for some finite time. That is, the hyperbolic system gives an indication of position, not of direction, and the indication does not depend at all upon the attitude of the vehicle. This is an important and valuable point. It makes navigation independent of currents in sea or air because, to reiterate, all courses and speeds directly derived from hyperbolic systems are ground courses and ground speeds.

A simple right-left indicator to show a pilot whether he is to the right or left of the Loran line he wishes to follow, or even how far to the right or left, will not be very successful in helping him follow the line because there is no appreciable relation between the indications on the meter and the course that the pilot should follow. Thus, if the meter shows him to be to the left of his desired track, he tends to turn more and more to the right, until he crosses the line at a large angle, and has to repeat the process in reverse. The net result is a zigzag track which, although it passes nearly over the objective, wastes large quantities of time, fuel, and the pilot's energy on the way.

Theoretically, this difficulty could be removed if the pilot would study the behavior of the right-left meter in enough detail to understand both

the degree of his displacement from the line and his rate of progress toward or away from it. With a knowledge of both these factors, he could return to the desired track by a gentle change of course and could stay on it with only small excursions. The pilot is, however, too occupied with the business of piloting to enter into such a study, so it is necessary to advance the equipment another stage and present to him both his rate of approach and the distance from the line he wishes to follow. He may be shown, for example, two meter readings, as is now done in Shoran (Sec. 7-13). One of these might tell him that he is 1000 ft to the left of the line, and the other that he is approaching the line at 50 ft/sec. It is clear immediately that, if he continues on the same course he has been holding, he will reach the line in 20 sec and that, if he wishes to come smoothly onto the line, he should begin to change course to the left. This conclusion is, of course, the opposite of that derived from the simple right-left indicator and shows clearly the defect in that presentation.

Within certain limits, it is possible to combine automatically the factors of displacement and rate of change of displacement. The pilot, therefore, would not need the two meters mentioned in the preceding paragraph, but could use a single indicator calibrated in terms of the appropriate course correction, such as "two degrees to the left." The only defect in this instrument would be a time constant dependent upon the time required to analyze the rate of approach to the track, requiring the pilot to learn not to make a second correction too soon after the first.

This difficulty would vanish if the meter indication, instead of being presented to a human pilot, were connected to a gyro-controlled automatic pilot. In that case the linkage to the automatic pilot could easily be given the appropriate time constant to prevent overcorrection.

The design suggested above is the simple and natural way to build a device that will automatically follow a Loran line. This is worth while because there is always a line passing through any target in a Loran service area, but it falls far short of the really desirable solution. The most important requisite of automatic equipment, like the human pilot-navigator combination, is the ability to proceed by a simple and reasonably direct course from wherever the vessel happens to be to wherever it should go.

This ability can stem only from simultaneous examination of two families of hyperbolas. There are many ways to make this examination, just as there are many ways to make a plotting board. One of them is so very simple that it should be mentioned here.

Assume a Loran receiver capable of following automatically two Loran readings in two families of hyperbolic lines. The shaft rotation corresponding to either of these readings could be connected through the displacement-and-rate device mentioned above to the rudder of the vessel.

Any desired Loran line in the corresponding family could then automatically be followed. A Loran line passing through the initial position of the vessel, for instance, could be followed until it intersected a line passing through the objective, after which instant the second line could be

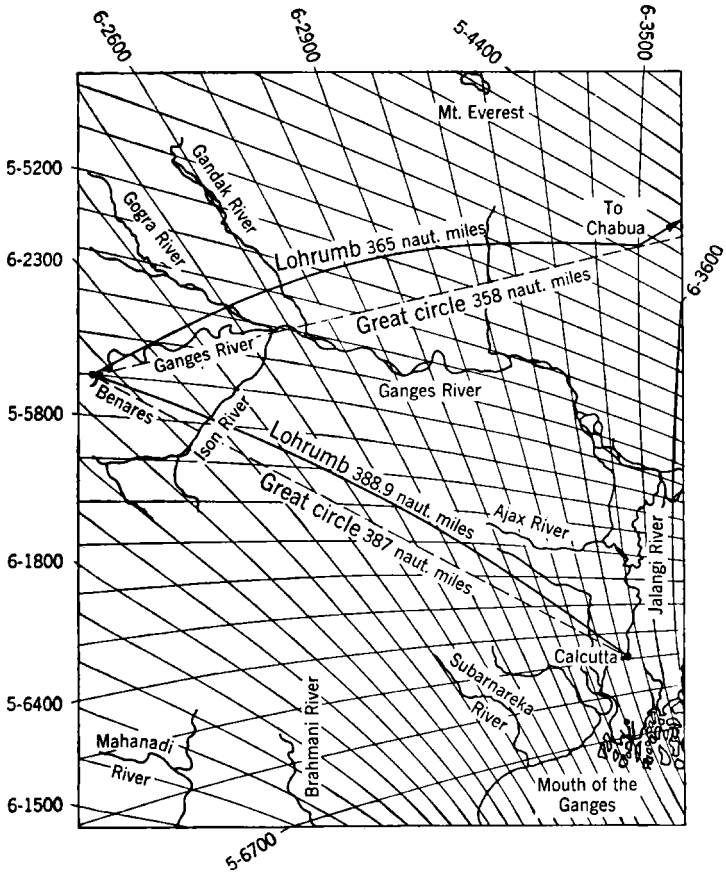

FIG. 2-16.—Two examples of the Lohrumb line, or curve, which intersects two families of Loran hyperbolas at a constant ratio. These lines can be followed automatically by the use of relatively simple equipment.

followed. Although this would produce the desired end result, it might be by a very indirect route indeed.

A much more direct path would be one cutting across both families of lines in such a way that the rates of change of the two Loran readings would constantly bear the same ratio to each other as the total change between initial and final readings. Along such a path, if the changes in

one Loran reading were followed automatically while the time difference for the second set of lines was constrained to vary in the designated ratio to the variation in the first reading, then the second pair of pulses, once set to coincidence, would remain so. The steering mechanism might be so controlled by the second pair of pulses that it would maintain the coincidence, thus directing the vessel along the chosen path.

For example, if the readings were 3500 at the initial point and 2700 at the objective on the first Loran pair, and 1400 and 1800 on the second pair, the linkage between the indications would be set at $-\frac{1}{2}$. The vessel would then follow such a track that it would successively pass through points whose Loran coordinates were (3400, 1450) (3300, 1500) . . . (2800, 1750) to the objective at (2700, 1800). The track would be almost direct unless it passed very near one of the transmitting stations. In fact, the track would differ from a great circle only in proportion as the Loran lines differed from being straight and parallel.

Figure 2-16 shows two lines of this sort drawn upon a Loran chart of part of India. The great circle from Calcutta to Benares is shown as a dashed line while the proposed curve, or "Lorhumb line," which crosses the East-West lines at two-thirds the rate that it crosses the North-South lines, is shown as a solid line. For the great-circle track, the shortest distance is 387 miles. The Lorhumb line is 1.9 miles, or 0.5 per cent, longer.

A second Lorhumb line is drawn between Benares and point *Q* which is about halfway from Benares to Chabua, off to the right of the map in Fig. 2-16. Here the geometry of the Loran lines is less favorable so that the proposed course is 7.0 miles, or 2.0 per cent, longer than the great-circle distance of 358 miles. If an attempt were made to span the distance from Benares to Chabua with a single Lorhumb line, the excess distance would be about 30 miles, or 4 per cent, of the total distance.

This sort of path has been called the "Lorhumb line" because it is the exact parallel, in hyperbolic navigation, of the rhumb line in Mercator sailing. Various Lorhumb lines might be connected by the navigator to form an approximate great circle or any other desired path. Devices utilizing this principle will probably be adequate for all navigational purposes (as distinguished from problems of pilotage) and will presumably be simpler than others which, through more complete analysis of the exact forms of the hyperbolic lines, could follow slightly more direct paths. The advantages of the design are so obvious that devices that embody this principle may be expected to be ready for experimental operation as soon as engineering talent is available.

PART II
AIRBORNE RADAR

CHAPTER 3

CHARACTERISTICS OF AIRBORNE RADAR

BY D. L. HAGLER, C. F. J. OVERHAGE, J. H. BUCK, J. J. HIBBERT,
G. A. GARRETT, H. FAHNESTOCK, JR., AND T. H. WATERMAN

INTRODUCTION

The purpose of this chapter is twofold—first, to present to the reader a picture of what an observer sees on his airborne radar indicator; and second, to show how this information may be interpreted and used as an aid to navigation and pilotage.

The most elementary method of air navigation consists of flying from landmark to landmark with little or no reference to instruments of any kind. This is usually supplemented by some form of dead reckoning to overcome poor visibility. The radar equipment, essentially, enables one to fly a similar reference-point course at night or through overcast and to use reference points at a much greater distance than is possible visually.

The scale of usable reference points in radar, of course, is different. Visually, roads, railroads, villages, parks, lakes, and rivers, usually within a 10-mile radius, are most useful for reference. On the radar indicator only towns, cities, larger lakes, and rivers are visible in recognizable forms; they can, however, be identified 20 to 50 miles away. When the reference points are not easy to identify individually, the pilot may find his position by using a map with his radar indicator to identify a combination of reference points.

In visual pilotage, the distance to an object and its angular position with respect to the airplane must be estimated. This is relatively easy to do at low altitudes, but at high altitudes, distances are extremely hard to judge, even on a clear day. With radar pilotage, guesswork is eliminated because range marks and an azimuth scale giving adequate accuracies can be superimposed on the picture.

3-1. Features Revealed by Radar Mapping.¹—When presented on a PPI, the basic range, azimuth, and signal strength information obtained by radar form a radar map of the territory over which the airplane is flying. This map, which displays the relative amount of energy reflected back to the antenna by the individual elements of the surrounding terrain, has a direct resemblance to its topographical characteristics.

¹ Sections 3-1 and 3-2 by D. L. Hagler and C. F. J. Overhage.

The correlation between the radar presentation and the actual terrain varies with the characteristics of the radar system, the altitude of the airplane, the type of terrain, and, in most cases, the direction from which it is viewed. The interpretation of the presentation is quite simple in some cases, but in others it requires a certain amount of experience and

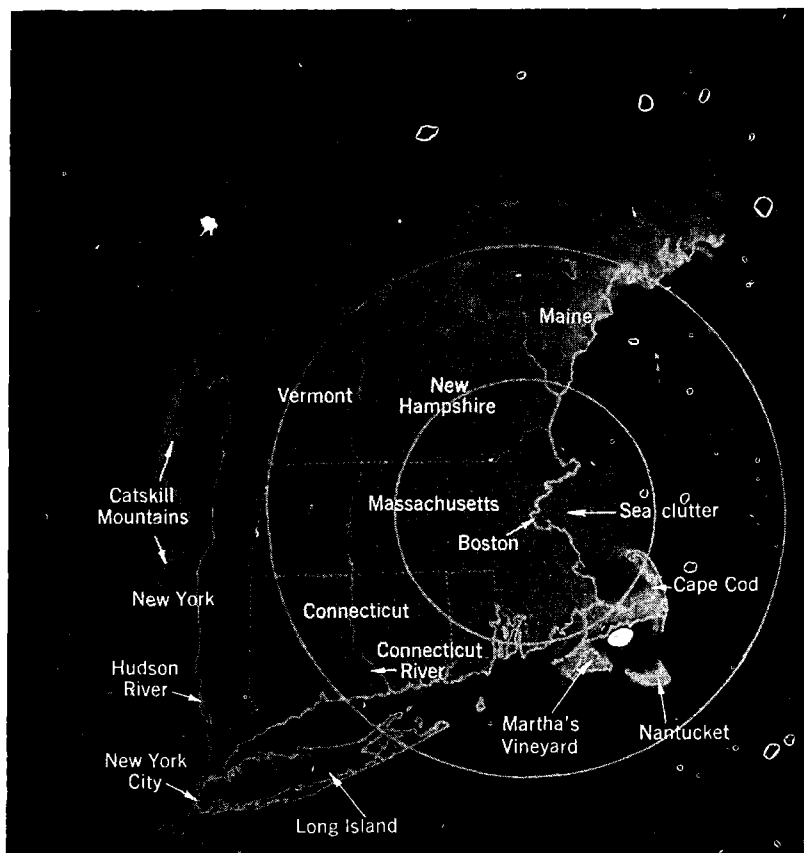

FIG. 3-1.—Comparison of long-range PPI presentation of northeastern United States with a map. Range circles at 50 and 100 nautical miles. Photograph taken near Boston, Mass., from 20,000 ft.

knowledge of radar principles—including an understanding of the various distortions and limitations of the PPI. This section describes the appearance of various terrains on an indicator of this type.

Land-water Boundaries.—The most striking and most readily identified terrestrial feature is the boundary between land and water. The smooth surface of water tends to reflect energy away from the radar

antenna, but the rough character of land causes energy to be scattered in all directions, including that from which it originated. Part of it, thus, returns to the radar antenna. In consequence, land areas appear bright on the PPI and the water remains dark. Figure 3-1 is a photograph of a PPI display of the New England coast from New York to Maine. Little imagination is required to correlate this display with the map of that area. Certain distortions are present in the display, however, and these become important for terrain that is not distinctive or when detailed features must be revealed.

As an example of the distortion associated with resolving power, a small body of water, such as a small river, might be obliterated on the PPI by the overlapping of signals from the land surrounding it. Many land or water areas seem to change shape when they are viewed from different directions, and often narrow water areas such as rivers, that can be resolved when viewed from the side, do not show up on the PPI when viewed lengthwise. These distortions are illustrated in Fig. 3-2, which shows two photographs of the PPI presentation of a pier and breakwater in Lake Michigan at East Chicago, Ind. Since the tangential distance corresponding to a given azimuth resolution increases with range, many objects which cannot be resolved at 20,000 ft or more can be separated at altitudes of 5000 ft or less.

General Features of Cities.—An airborne radar system adjusted to display land-water boundaries as effectively as possible usually presents saturated signals from all land areas within a given range. These areas appear on the indicator as regions of uniform brightness. If the receiver gain of such a system is gradually decreased, the display corresponding to land areas becomes less uniform. Built-up areas are particularly effective in redirecting radiation toward its source; with proper gain adjustment, such areas can easily be distinguished from the surrounding countryside. This feature is the key to the use of radar in overland navigation.

The characteristic properties of signals from built-up regions are discussed qualitatively in this section and illustrated by photographs of radar displays obtained in flight tests. The points under discussion can best be demonstrated with systems of high resolving power, and the illustrations have been chosen predominantly from the results of experimental 1.25-cm system flights at low and intermediate altitudes. With systems of lower resolving power, and at high altitudes, the features presented in these photographs become less distinct but retain considerable navigational value. Engineering and economic considerations, however, may often make it impractical to insist on the quality of the performance illustrated by these photographs.

At very long ranges, the radiation is incident at a grazing angle, and

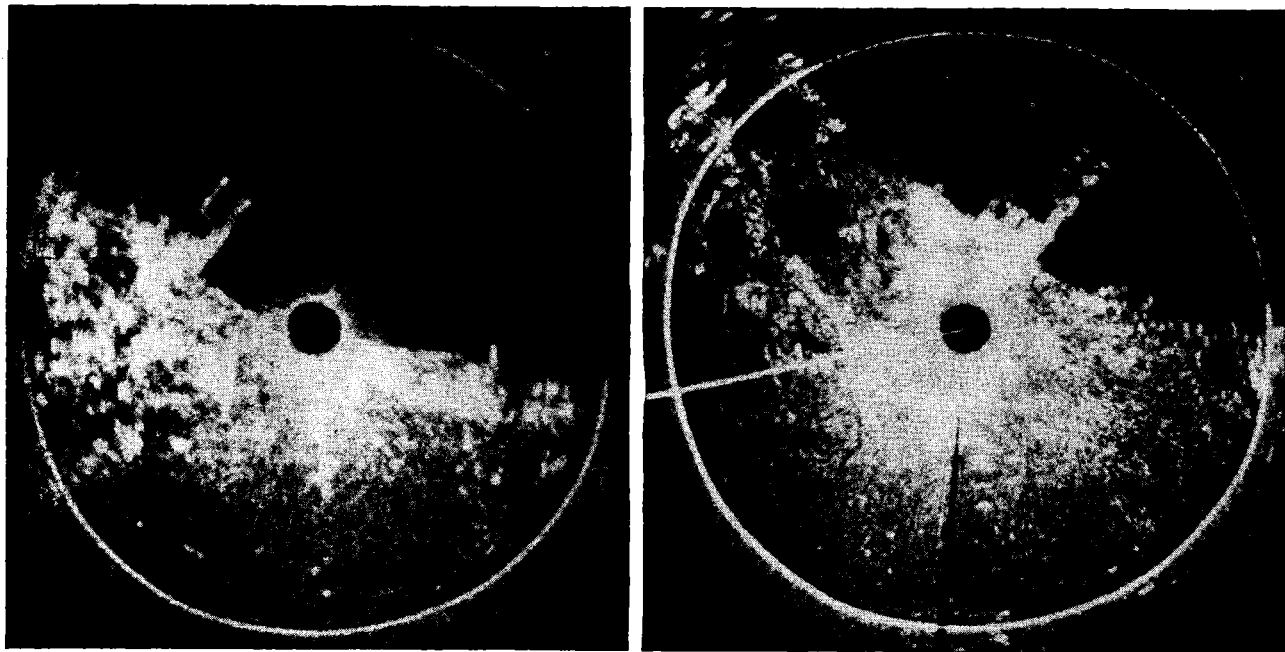

FIG. 3-2.—Pier and breakwater in Lake Michigan, East Chicago, Ind. PPI distortions cause the apparent shape to change when viewed from different directions.

the vertical surfaces of built-up regions reflect much more strongly in the direction of the aircraft than do the surrounding elements of flat country. Large cities can, therefore, be seen as strong signals at ranges where the general ground return is no longer distinguishable above receiver noise.

At shorter ranges the presence of many vertical surfaces in built-up areas, and the combinations of such surfaces into retrodirective corner

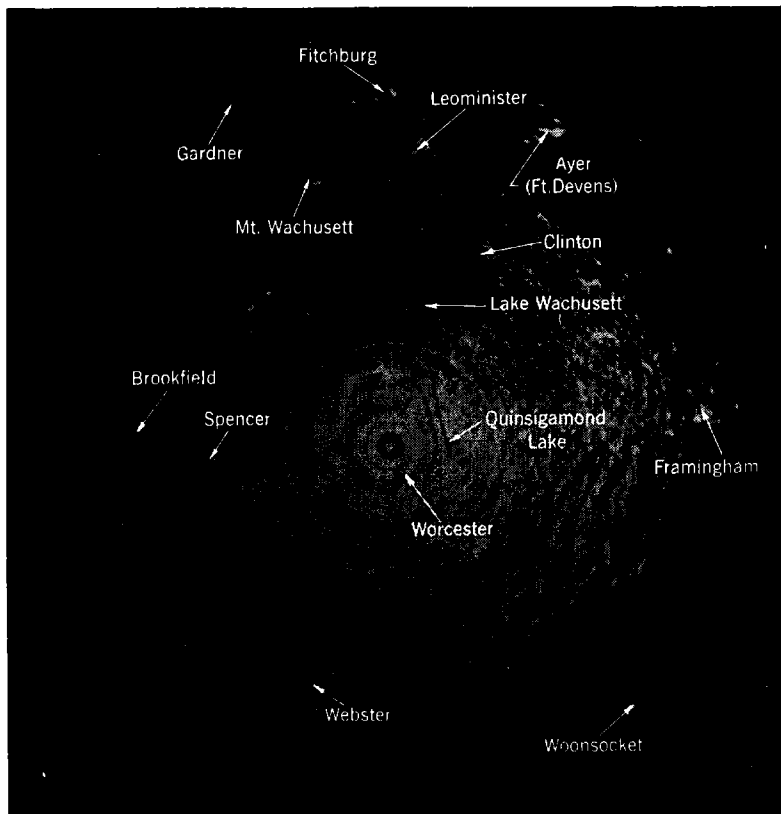

FIG. 3-3.—Identification of position by a group of signals. Small towns near Worcester, Mass., from 7000 ft. Sweep length, 24 nautical miles; 0.8° beamwidth; $\frac{1}{2}$ - μ sec pulse.

reflectors, result also in increased reflection of energy relative to the adjacent open country. When the indicator sweeps are adjusted to these shorter ranges, the region containing many surfaces of this type will occupy a finite area on the scope, and this area will have a characteristic shape corresponding roughly to the extent of the densely settled area of the city in question.

The observer thus has two valuable means of identifying his position

in overland navigation. In the first place, the bright signals corresponding to various towns form a definite pattern by their positions relative to each other; this "constellation" can be identified by comparison with a map, especially if the map has been prepared for this purpose by deleting other information. In the second place, the shape of the mass of bright

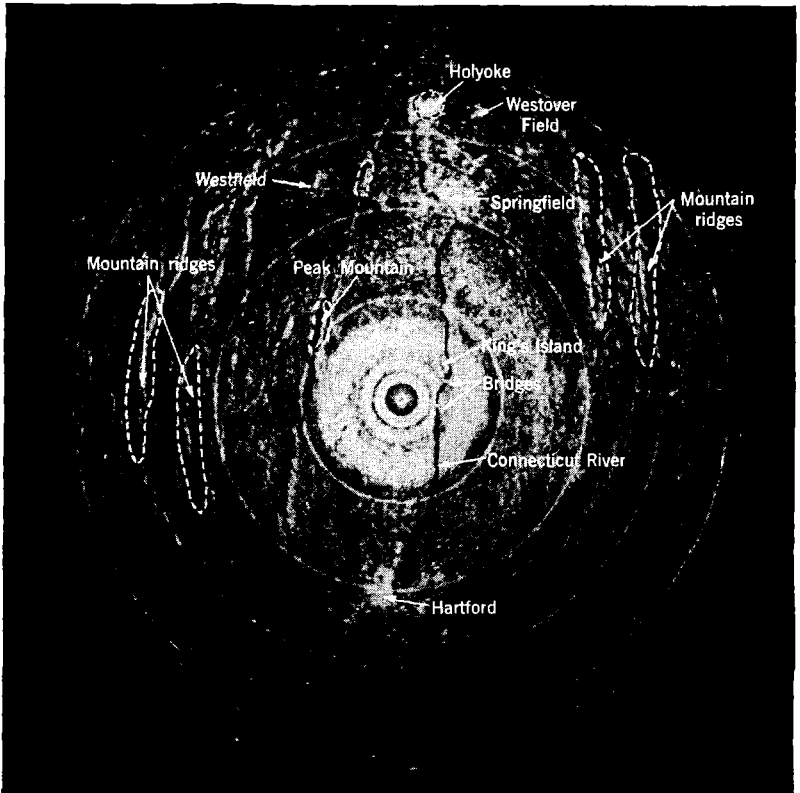

FIG. 3-4.—Identification of position by the shape of built-up areas. Hartford, Conn., and Springfield, Mass., from 7000 ft. Sweep length, 20 nautical miles; 0.8° beamwidth; $\frac{1}{4}$ - μ sec pulse.

returns from an individual town may be characteristic of only one particular town in that general region.

These characteristics of overland signals are illustrated in Figs. 3-3 and 3-4. The first of these shows a number of small towns in the vicinity of Worcester, Mass. A characteristic constellation of five bright signals is apparent near the top of the photograph. The signal nearest the aircraft is from a mountain and is readily identified by the characteristic

shadow extending away from the center toward the top of the picture. The remaining four signals represent the towns of Gardner, Fitchburg, Leominster, and Ayer (including Ft. Devens).

Figure 3-4 shows two cities, Springfield, Mass., and Hartford, Conn., which can be identified by their characteristic shapes. In this photo-

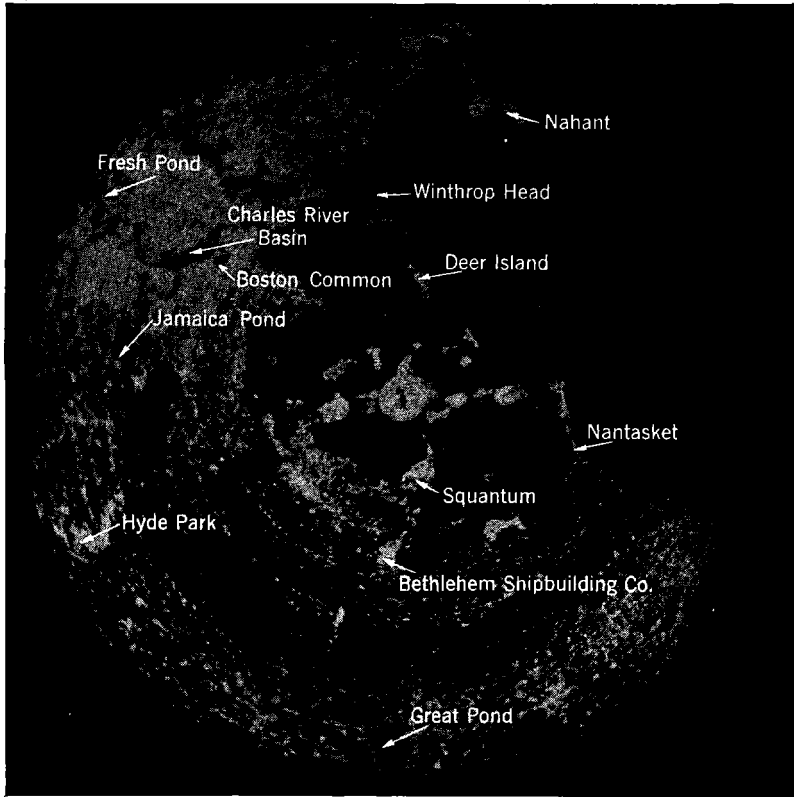

FIG. 3-5.—Detail observed in built-up area with a high-resolution radar. Boston outer harbor from 8000 ft. Sweep length, 10 nautical miles 0.8° beamwidth; $\frac{1}{4}$ - μ sec pulse.

graph the clear indication of the Connecticut River contributes to easy recognition.

In identifying built-up areas from the shape of the bright radar returns, two important factors must constantly be borne in mind to prevent misinterpretation. First is the dependence of signal strength upon range. The built-up regions nearest the aircraft will often be brighter than those farther away. In viewing a city from a distance of 5 to 10 miles, for instance, the nearer suburbs will be more conspicuous

than those farther away. The operator must learn to overcome a tendency to locate the center of a city too close to the airplane when he is estimating its location from shape interpretation. The second difficulty arises from the unstable nature of the individual radar responses that constitute the pattern. These exhibit considerable variation as the aircraft moves along its path; small variations in aspect angle can cause very large fluctuations in signal strength. This simply means that the

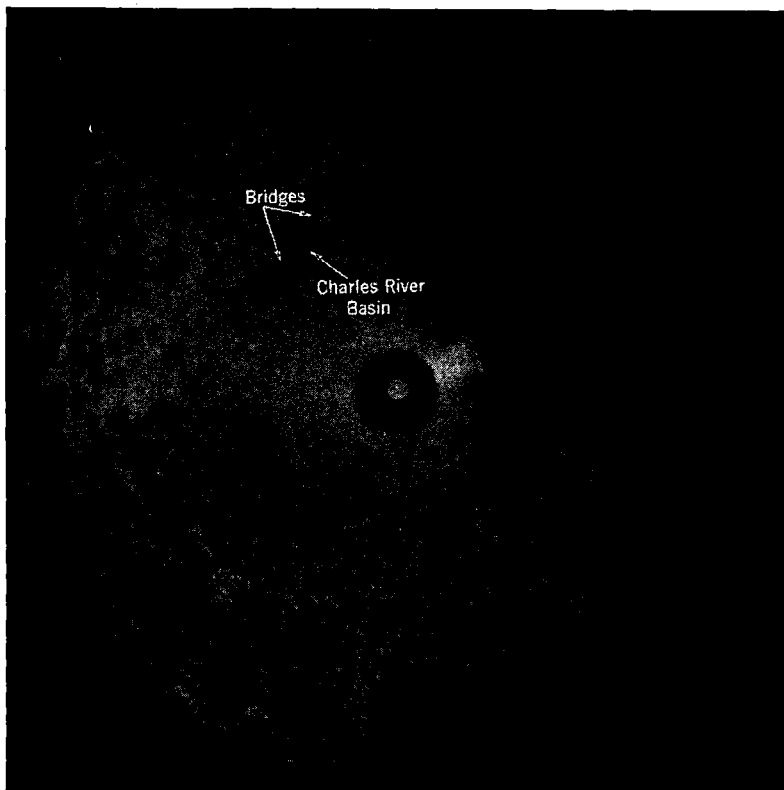

FIG. 3-6.—Detail observed in built-up areas with a conventional antenna beamwidth of 3° .

appearance of structures and built-up areas varies with time as well as with the direction of approach. Although experience greatly reduces errors in observation arising from these causes, it is essential that charts and other briefing aids be prepared for the particular conditions of approach and aspect under which the area is to be recognized.

3-2. Details in Radar Mapping. Built-up Areas.—In almost all built-up regions, additional information of considerable value is contained

in the detailed variations of brightness which become apparent at close range. Many cities contain important and characteristic water areas. In Fig. 3-5, the bright region at the upper left represents the densely built-up area of Boston, Mass. The characteristic shape of the Charles River basin with its two traffic bridges provides unmistakable identi-

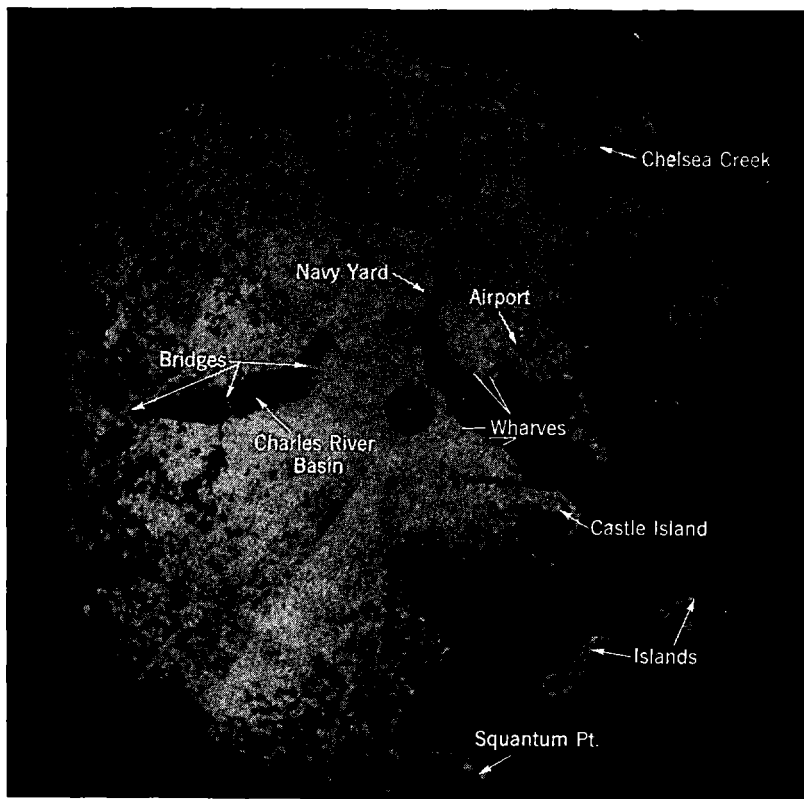

Fig. 3-7.—Increased detail is evident from a lower altitude. Boston, Mass., from 4000 ft. Sweep length, 5 nautical miles; 0.8° beamwidth; $1\text{-}\mu\text{sec}$ pulse.

fication. A smaller dark patch, slightly closer to the center, represents the Boston Common; various watercourses, together with the shoreline, provide easy landmarks for the identification of various parts of the city. A similar photograph obtained with a conventional 3-cm radar having an antenna beamwidth of 3° is shown in Fig. 3-6. Figure 3-7 shows the increased detail which becomes visible at close range. Figure 3-8 shows a portion of New York City in which immediate identification is possible

by reference to the Hackensack, Hudson, Harlem, and East rivers, together with Central Park and the bridges.

In cities that have fewer characteristic water patterns or large parks it is sometimes possible to discern a few prominent features of the street pattern. A complete presentation of the street pattern would, of course, be ideal for identification. Radar equipment now in use, however, does

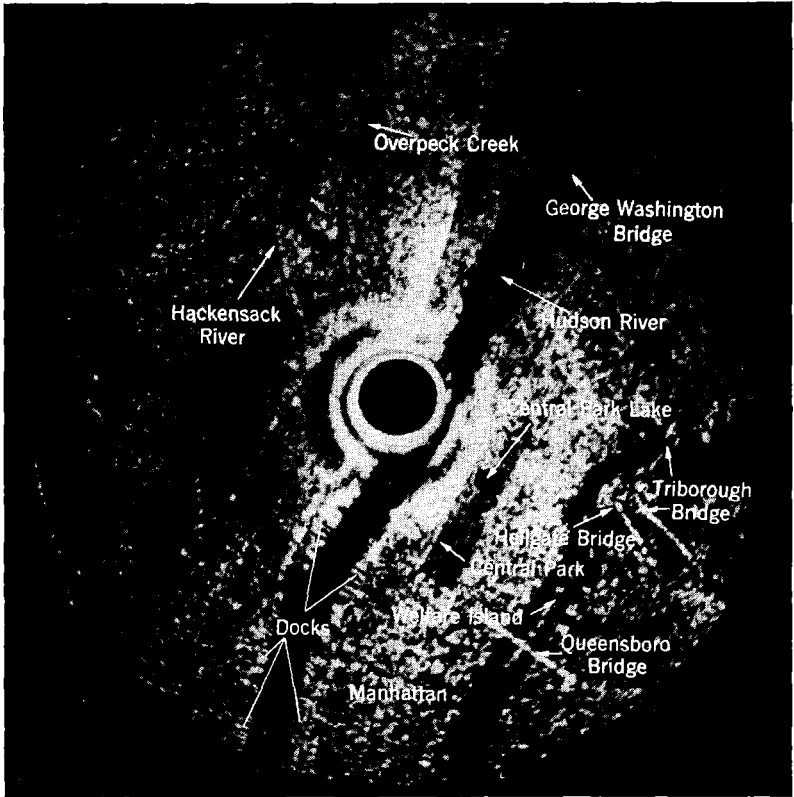

FIG. 3-8.—Rivers, parks, and bridges characterize the radar map of New York City. Sweep length, 6 nautical miles; 0.8° beamwidth; $4\text{-}\mu\text{sec}$ pulse; altitude, 8000 ft.

not have the resolution in either azimuth or range to make this possible. Hence it is only at very low altitudes and very short ranges that major thoroughfares can be seen as dark lines in the bright mass of city returns. Figure 3-9 shows a dark trace corresponding to Commonwealth Avenue in Boston, Mass.; this photograph was obtained with an experimental high-resolution system at an altitude of only 2000 ft.

The concentration of large buildings along major streets and the

presence of elevated railways or overhead trolley systems often result in a concentration of particularly bright signals along such streets, however. The street patterns of Chicago, Ill., and Detroit, Mich., which are partially visible in Figs. 3-10a and 3-10b, are of this type. Some caution is necessary in the interpretations of such displays; bright radial lines are occasionally caused by directionally selective reflection from a mass of buildings with parallel surfaces. Such lines appear to move along with the aircraft, and can thus be distinguished from streets, which are stable with respect to other signals.

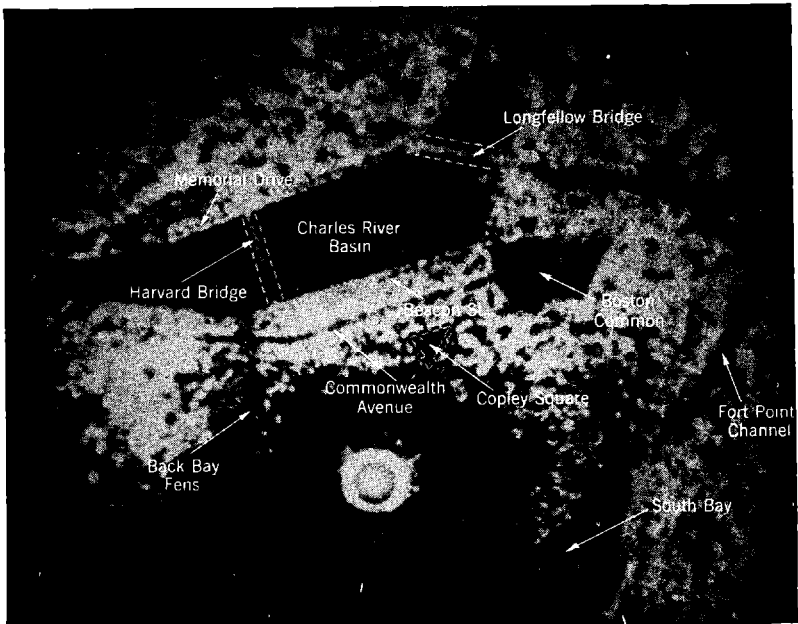

FIG. 3-9.—Street patterns are sometimes evident at very low altitudes. Charles River Basin, Boston, Mass., from 2000 ft. Sweep length, 3 nautical miles; 0.8° beamwidth; $\frac{1}{2}$ - μ sec pulse.

The receiver-gain adjustment required for the best presentation of these bright overland signals is different from that required for the best presentation of land-water boundaries. Experienced operators, therefore, continually vary the receiver gain in order to produce the best contrast for each topographic detail that aids identification. This process calls for mental integration of successive presentations; it is much simplified by automatically and rapidly switching the receiver gain back and forth from the best condition for land-water contrast to that best for overland contrast. Simultaneous display of both types of presentation

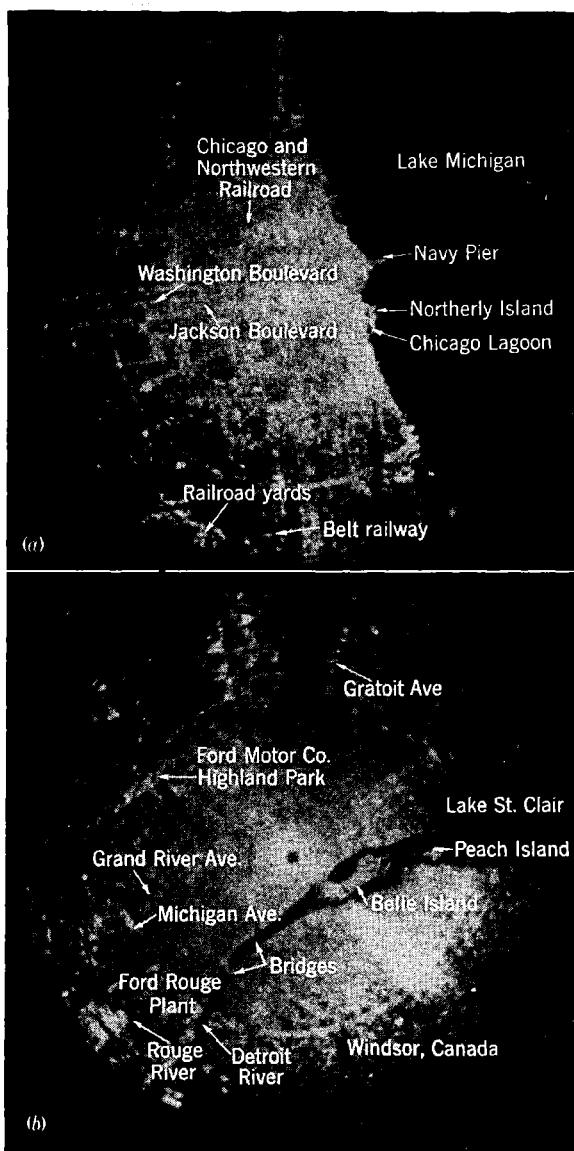

FIG. 3-10.—Street patterns resulting from large buildings and railway systems. Sweep length, 10 nautical miles; 0.8° beamwidth; $\frac{1}{4}$ - μ sec pulse; altitude, 4000 ft. (a) Chicago, Ill., (b) Detroit, Mich.

can be achieved by "three-tone" receiver construction, which is discussed in Sec. 5-1.

The amount of detail visible in radar presentations of built-up areas increases enormously as the resolving power of radar systems is improved. The obvious value of such detail in identifying targets for bombardment has been a strong incentive to the development of high-resolution radar

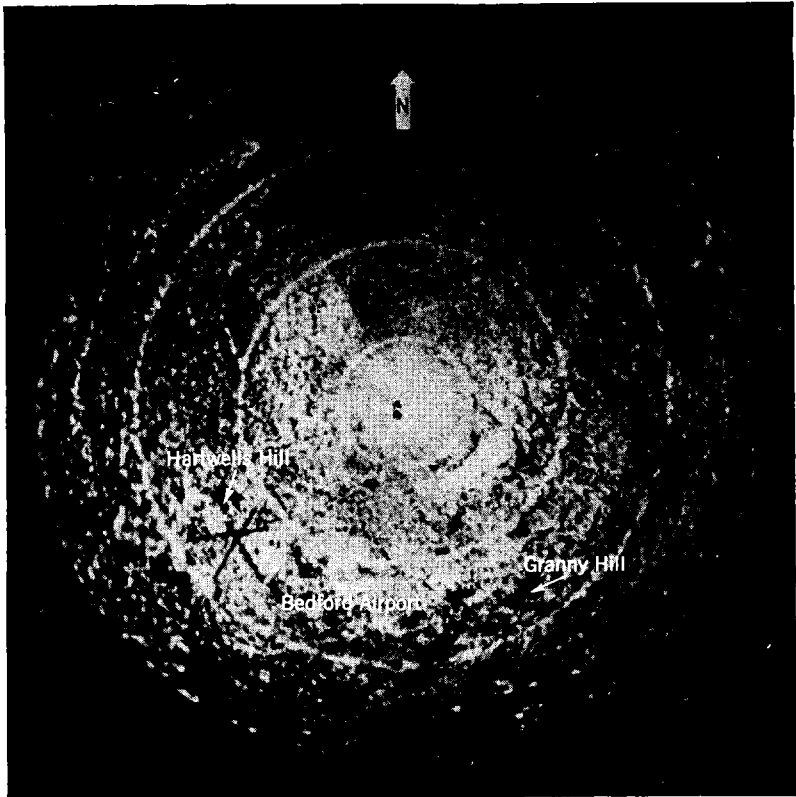

FIG. 3-11.—Runways at Army airfield, Bedford, Mass., from 2000 ft. Sweep length, 4 nautical miles; 0.8° beamwidth; $\frac{1}{2}$ - μ sec pulse.

systems. The reduction of azimuth beamwidth to values below 1° has necessitated the use, even at 1.25 cm, of larger radar antennas (a 34-in. reflector for 1°) than may be tolerated in commercial transport practice. On the other hand, extreme resolution of detail is much less important for navigational purposes, and the more compact AN/APS-10 system, described in Sec. 6-3, appears to meet all the essential requirements of overland navigation by radar.

Returns from Highways and Runways.—The paved surfaces of airport runways usually scatter less energy than the surrounding ground, especially if it is rough or grass-covered. Paved surfaces large enough to be resolved, like water areas, appear dark on the PPI. The contrast in signal strength, however, is not so great as that for land-water boundaries. For that reason, the contrasting signals are more easily lost on the PPI by improper receiver-gain adjustment. Observations of airport runways



FIG. 3-12.—Highway displayed on an off-center PPI, 0.8° beamwidth, $\frac{1}{2}$ - μ sec pulse.

on a PPI have been made at distances up to 10 miles. Figure 3-11 shows the runways of the Bedford Airport near Boston, Mass.

Highway pavement is generally too narrow to be resolved by a conventional radar system, although wide, four-lane, super-highways have been observed as dark lines on the PPI's of high-resolution radar sets, as shown in Fig. 3-12. When this happens, however, it is probable that detection is aided by the cleared right-of-way on either side of the pavement. Narrower roads are usually bounded by telephone wires, fences, embankments, trees, billboards, and small buildings and reflections from

these objects add up to produce a bright line on the PPI, corresponding to the route of the highway. In most cases, therefore, highways can be identified.

For the same reason, railroads often appear as bright lines on a PPI. The four-track electrified main line of the Pennsylvania Railroad between New York and Philadelphia produces a strong signal. It is possible to



FIG. 3-13.—Southern California mountains from 13,000 ft with a 3-cm production radar. The range circles indicate 5-mile intervals.

identify single-track railroads across swamps, but not those traversing wooded country.

Mountain Relief.—Mountains are indicated chiefly by dark areas or shadows. The far slopes, not illuminated by the radar beam, appear dark. With proper adjustment of the receiver gain, the near slopes of mountains appear brighter than level ground. The net effect of the

somewhat brighter signal from the near slopes and absence of signal from the far slopes is a presentation resembling a relief map. A photograph of the PPI display of a mountainous region in southern California is shown in Fig. 3-13.

Obviously, the shapes of the bright and dark areas caused by mountainous terrain vary greatly with the angle of incidence of the radar beam,

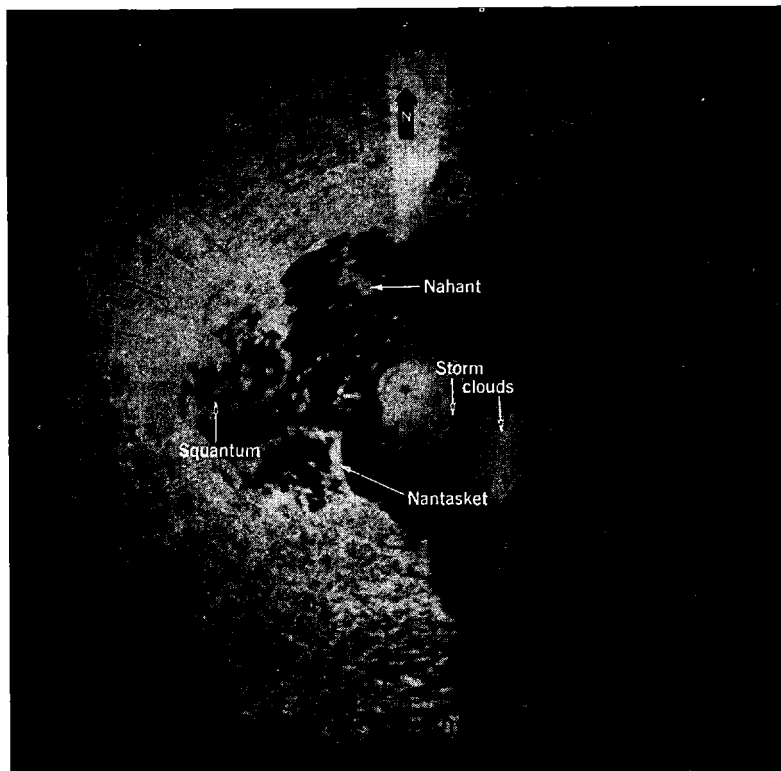

FIG. 3-14.—Presentation of storm clouds in Boston Harbor, Mass., on a 3-cm radar. Pulse length $\frac{1}{2}$ - μ sec, beamwidth 5° .

which is a function of the position and altitude of the airplane; consequently, identification of a particular mountain in an extensive range is difficult. However, the 15th Army Air Force, which was based in Italy in 1944 and 1945, did use this sort of display as an aid to navigation through passes in the Alps. Isolated mountains in flat country are easily identified and provide useful landmarks for air navigation.

Storm Detection.—The problems of atmospheric scattering of microwave energy by rainfall were discussed in a general way in Sec. 1-5.

Signals from storms have been observed on airborne radar sets at ranges as great as 50 miles. They differ from those of most other objects because they have less distinct boundaries, usually change in shape and size, and persist even when the antenna is tilted upward and the ground signals disappear. Figure 3-14 shows a storm area on a PPI display of Boston harbor. The characteristic appearance of the storm may be compared with the sharp boundary between land and water. Note that the radar return from the central portion of the storm area is strong enough to obscure the return from ships that might be located on the ocean below.

3-3. The Operator.¹—The two previous sections described the information that can be obtained by observation of the PPI of an airborne radar. In this section the necessary qualifications of the radar operator are discussed.

It is easy to operate an airborne radar set and to obtain signals on the PPI, but it is difficult both to operate the equipment intelligently and to interpret the picture correctly. The operator must be trained to look at the PPI as we ordinarily look at a photograph. It is equivalent to analyzing an X-ray in which bright blobs must be recognized as towns and cities, dark spots as lakes or mountain shadows. This interpretive ability comes only with training and practice.

A poorly trained operator gets land-water contrast but no detail of the land even with a high-resolution set. At least 25 to 50 hours of actual operating experience are required to learn the proper technique to make railroads, buildings, etc. stand out clearly. Only then can the operator properly and completely interpret his oscilloscope picture.

Not all of the required training need be done in the air. In fact, better initial training can be done on a supersonic trainer on the ground, away from the noise and complications of flying. Like the Link trainer, the supersonic radar trainer gives the operator the fundamental ideas of radar operation, teaches him the initial knob twisting, and enables him to practice measurements of ground speed and drift at any time. Teaching is infinitely easier on a ground trainer than in an airplane because the operator's errors and progress can be checked directly.

3-4. Measurement of Drift and Ground Speed.² *Conventional Methods.*—Navigation of an airplane can be compared with the problem of determining the angle at which a canoe should be headed upstream so that it will travel in a straight line to a point directly across the river. This angle is a function of the speed of the canoe and of the river current. The velocity of the current is exactly analogous to the velocity of the air mass (that is, the wind) through which the airplane flies. We may speak of the airplane heading as the direction in which it is pointing—the

¹ By J. H. Buck.

² By J. J. Hibbert.

direction of flight with respect to the air-mass—while the angle between the airplane heading and the actual path over the ground (ground track) is called the drift angle. This is illustrated in Fig. 3-15.

The problem of flying a specified ground track is one of determining the velocity and direction of the wind in which the airplane is moving. This requires a knowledge of the movement of the airplane with respect to objects on the surface of the earth. Such information may be obtained by several consecutive determinations of the position of the airplane by either pilotage, radio direction-finding, or celestial navigation so that the ground track can be drawn and compared with the air track. It may also be determined by observing the motion of objects on the ground through a visual drift indicator. In this latter case, the drift angle is measured directly. By making two determinations of the drift angle with the aircraft on two different headings, both the magnitude and direction of the wind can be evaluated. The work is greatly simplified by the use of

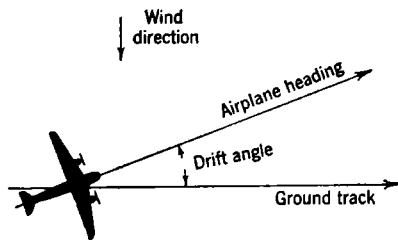

FIG. 3-15.—Illustration of terms commonly used in air navigation.

measure drift angles. They are the radar fix, the cursor, and the pulse doppler methods. An extension of the last could be used to provide a direct-reading ground-speed meter.

Radar Fix Method.—This method establishes two or more consecutive positions of the airplane so that the ground track can be drawn. It is analogous to visual pilotage. Its disadvantage is the length of time required to make the wind determination, particularly because the airplane heading and speed must be kept constant during the measurement.

Cursor Method.—When this method is used, a transparent disk engraved with a radial cursor line and with a series of evenly spaced lines parallel to it is mounted over the face of the PPI. This disk can be rotated concentrically in front of the indicator tube. A degree scale is mounted on the rim in such a way that the angular position of the cursor line can be measured. In addition, a so-called "lubber line" appears on the PPI presentation. This is a bright line on the face of the tube which appears whenever the antenna is pointed along the longitudinal axis of the airplane and indicates its heading.

a navigational computer such as the E6B computer of the Army Air Forces. From the wind information placed on the E6B the ground speed and drift angle at any other heading or air speed can be computed.

Drift Determination Using Radar Systems.—There are three general methods by which radar mapping systems may be used to

In operation the cursor line is adjusted so that radar signals appear to move parallel to the cursor, in a way very similar to that employed by the optical drift sight. When this adjustment has been made, the cursor line is in the direction of the ground track of the airplane, and the angle between the cursor and the lubber line is the drift angle of the airplane for that particular heading. Furthermore, by measuring the speed with which the radar targets move down the cursor line, or along the lines parallel to it, the ground speed of the airplane can be determined.

This is a fairly satisfactory method of using the radar system for navigation, except over water where the absence of identifiable signals makes its use impossible. Its disadvantages are: (1) the difficulty in setting the cursor line parallel to the apparent motion of the radar echoes because of uncertainties resulting from changes in range and aspect of a signal; (2) the parallax present because of the separation of the PPI and the mechanical cursor line (this can be eliminated by using an electronic cursor or by using the optical arrangement shown in Sec. 5-2); (3) the difficulty of centering the cursor accurately over the PPI presentation; and (4) the length of time required for an error in the setting of the cursor to be perceived.

Doppler Drift Determination.—The doppler frequency shift of radar echoes may be used for rapid determination of the ground track of the airplane. It is closely analogous to the increase in pitch that is commonly observed from the whistle of an approaching locomotive.

In the case of radar waves transmitted from a moving airplane, the signals are transmitted by a moving source and reflected back to the aircraft which is then a moving observer. Here the velocity of the source in the direction of the observer is the component of the ground speed of the airplane in the direction of the reflecting surface which is fixed on the ground. This velocity is a maximum along the ground track of the airplane and is then equal to the speed of the airplane.

It can be shown that the frequency received from any point reflector is given by the following relationship,¹

$$f_r = f_t + 2 \frac{v_g \cos \theta}{\lambda_t} = f_t \left(1 + 2 \frac{v_g}{c} \cos \theta \right) \quad (1)$$

where

f_r = received frequency,

f_t = transmitted frequency,

λ_t = wavelength of the transmitted signal as measured in the airplane,

v_g = airplane ground speed,

¹ For a derivation of this relationship consult any standard textbook on physical optics. The factor of 2 appears because both the transmitter and the receiver are moving with respect to the target.

- θ = angle between the ground track and the direction in which the antenna is pointed,
 c = velocity of light.

(Note: This formula assumes that the reflector is far enough removed from the airplane so that its slant range is approximately equal to its ground range.) The second term of the expression, $\frac{2v_r \cos \theta}{\lambda_t}$ represents the change in frequency of the received signal as compared with that transmitted. The airplane catches up with signals sent out ahead of it ($\theta = 0$, $\cos \theta = 1$) with a resulting increase in frequency, and is going away from signals sent to the rear ($\theta = 180^\circ$, $\cos \theta = -1$) with a resulting decrease in frequency. However, signals sent directly to the side ($\theta = \pm 90^\circ$, $\cos \theta = 0$) experience no frequency change because instantaneously the airplane moves parallel to the reflecting surface and the relative radial velocity between source and observer is zero.

The above idealized conception must be modified by two considerations in actual radar installations. First, the radar beam has a finite width which is commonly between 1° and 10° . Second, the transmitted pulse has a finite duration. Because of these two properties, the signal received at any given place on the indicator screen will be composed of echoes returned from an area or collection of "point reflectors" (small targets) rather than from the single point reflector previously considered. Because the relative velocity of each of these points with respect to the airplane differs (that is, the value of θ in Eq. (1) differs for each point) the frequency of the signal returned from each point reflector is different. The composite radar signal returned to the airplane will, therefore contain a number of frequencies, each differing slightly from the transmitted frequency. When a signal containing a number of frequencies is applied to the radar receiver, its output will contain frequency components equal to the differences in frequency between each input component and every other input component—the so-called difference beat frequencies. The output signal corresponding to this block of signals will vary in intensity at this rate. If the difference beat frequencies are low enough (less than about 20 cps) this variation in intensity will be discernible to the human eye. For frequencies greater than 20 cps it appears simply as a blur.

When the radar beam is pointed directly along the ground track, the frequencies from points at equal distances on either side of the center of the beam are the same because the value of $\cos \theta$ is the same whether θ is positive or negative. Moreover, for small values of θ , the value of $\cos \theta$ is very nearly that for θ equal to zero. In other words, there is very little difference in the relative velocities of various objects in the beam with respect to the aircraft. Therefore, the beat notes will be most nearly

equal to zero and will be discernible to the eye on the PPI. When the beam is pointed away from the ground track, the frequencies of echoes received from objects on either side of the center of the beam differ by an increasing amount. The beat note then increases rapidly as the angle between the ground track and the center of the radar beam is increased and it will be a maximum for θ equal to 90° . It should be noted that the observed beat frequency is greatest when the doppler shift itself is least, and vice versa.

By turning the antenna slowly, it is possible to find the direction of the beam for which the beat frequency is a minimum. From our previous argument we learned that this direction is along the ground track of the airplane.

From the foregoing discussion it can be seen that for this method of determining drift, the radar must be equipped with a control mechanism that will permit the operator to adjust the position of the antenna easily and smoothly. In addition, some indication of the position of the ground track should appear on the PPI when the ordinary mapping function is resumed. This has been done in military installations by the use of the circuits in the servomechanism for the dual purpose of controlling the position of the antenna and of providing a bright line on the PPI that indicates the ground track as determined on a particular heading of the aircraft. As the drift angle changes with time or aircraft heading, a new determination of the ground track must be made. For convenience, the azimuth control of the antenna may be calibrated to read the drift angle directly in degrees right or left.

For ease in observing the doppler beat-frequency, a PPI should be viewed through a blue optical filter which permits observation of signals whose intensity is changing rapidly. This is in contrast with the use of an orange filter when it is desired to view the persistent echoes. However, pulse doppler phenomena are most easily observed on an A-scope and it is recommended that radar systems using this technique be so equipped.

For a system with a frequency of 10,000 Mc/sec and a beamwidth of 3° , a determination of the drift angle by the pulse doppler method can be made in about 30 sec. The drift angle determined in this way when flying over ordinary terrain is within $\pm 0.5^\circ$ of the actual value. If the air is rough—as it may easily be over mountainous terrain—so that the instantaneous ground track of the airplane is changing rapidly, it is desirable to take a series of readings and average the results. In this case, the error of the determination may be increased to about $\pm 1^\circ$.

Two disadvantages of the method outlined above are the requirement that the scanning be stopped so that the beam can explore the region on both sides of the ground track, and the necessity of redetermining this

track wherever a major change in the airplane heading is made. An ideal system would have an instantaneous direct indication of the ground track of the airplane at all times. The fact that several unsuccessful attempts to perform this function have been made emphasizes both its difficulty and desirability.

Possibility of Instantaneous Ground-speed Determination by Doppler Method.—An examination of Eq. (1) discloses the interesting fact that the absolute value of the doppler frequency shift of radar waves when measured along the ground track is directly proportional to the ground speed of the aircraft. Therefore, a direct-reading frequency meter could serve as a ground-speed indicator. Along the ground track ($\theta = 0$), the doppler frequency shift becomes exactly $\frac{2}{\lambda_t} v_g$. Specifically, the doppler shift for a ground speed of 150 mph and a frequency of 11,780 Mc/sec (a wavelength of 2.54 cm) would be 5280 cps, whereas at 300 mph it would be twice this value. These frequencies are in the audible range where direct-reading frequency meters have been available for some time.

Several methods of using this phenomenon to measure the ground speed of airplanes have been proposed. As in the case of radio altimeters, either continuous wave or pulsed radiation may be used; the arguments which have been brought forward do not conclusively favor either. Sufficient power must be available in order that echoes will be received from targets at ranges so great that the slant range and ground range are nearly equal, or as an alternative the antennas might be arranged to point down at a fixed known angle.

The antenna system employed might be either a rotatable beam or two fixed antennas with one pointed to the right and the other pointed to the left of the longitudinal axis of the airplane. In the former, it will be necessary to point the antenna in the direction in which the ground speed is a maximum to determine the ground track and speed. In the latter, a vector addition of the two components of ground speed obtained from the two antennas will determine both ground speed and track.

Although no completely successful system employing the doppler frequency shift to measure the ground speed of aircraft has yet been built, future development may unravel the difficulties and provide the airplane with the equivalent of the automobile speedometer.

3-5. Determination of Drift and "Ground Speed" Over Water.¹—The optical solution to the problem of drift and "ground speed" over water may be simple when weather does not interfere with visual sighting of the water surface. In daylight the optical-drift sight may be used to sight on wave crests or on a drift marker—an object dropped from the aircraft in flight which floats on the surface of the water. At night,

¹ By J. J. Hibbert and N. W. MacLean.

floating flares may be dropped. Information obtained in these ways is used in the manner described in the preceding section. Overwater sights give the relative air-ocean current drift, but because the ocean current is small, the measurement is usually regarded as one of drift relative to the ground.

Just as in overland navigation, drift angle may be found from two fixes obtained in any convenient way. Unfortunately, in overwater navigation, when the only signal available is the echo from the sea itself, the pulse doppler radar technique has not yet been applied successfully. Limited tests indicate that a radar system with a frequency of 10,000 Mc/sec (3 cm) and a beamwidth of 3° gives no indication of the ground track when flying over water. On the other hand, at 3000 Mc/sec (10 cm) with a 7° beam, a minimum beat frequency can be detected but no change in it can be observed over an angle of 20° centered about the ground track.

Although the reason for this apparent failure of the conventional pulse doppler technique has not been established definitely, it is probably the result of extraneous doppler frequency shifts caused by the motion of the waves or ripples. Each of the reflecting wave or ripple surfaces is moving with its own particular velocity which must be considered in calculating the doppler shift of the radar signal. Because this velocity may vary from wave to wave and over the surface of a single wave, the echo signal will contain a mixture of frequencies. Even if the radar beam were pointed directly along the ground track of the airplane and there were a minimum frequency corresponding to the aircraft motion, this frequency might be masked by the doppler frequencies caused by the movement of the waves.

This hypothesis would also explain the failure to detect any frequency minimum when 10,000 Mc/sec are used, while a rough minimum can be detected at frequencies in the vicinity of 3000 Mc/sec. At the higher frequency, minor irregularities moving with random velocities on the wave surface are large enough to reflect a substantial amount of energy. Therefore, a much greater random variation in the degree of frequency shift would be expected. At 3000 Mc/sec, the signal is returned mainly from the larger waves and hence is not subject to so many perturbations.

In spite of this somewhat discouraging prospect, experimental evidence is far from complete, and so it is entirely possible that for some other radar frequency and beamwidth a pulse doppler determination of ground track over water could be developed. Moreover, modified applications of the doppler phenomena such as those described in Sec. 3-4 might provide both ground-speed and drift information.

The approximate direction of surface winds may sometimes be obtained by noting the appearance of sea return on the radar screen.

If the surface wind direction has been fairly constant for a period of a few hours, sea return will be most prominent in a direction upwind from the aircraft.

Corner reflectors that can be dropped from the airplane (see Sec. 9-4) have been used over water to provide radar signals useful in determining drift and ground speed. The maximum range at which such reflectors have been of value to this problem at 3 cm is about 6 miles. This means that by suitable maneuvering of the aircraft, the reflector could be observed during about 12 miles of flight. The maximum range at which corner reflectors can be used decreases as the altitude of the aircraft increases because of the nature of the reflector radiation pattern. The highest altitude at which nominal ranges of 5 or 6 miles can be obtained using the corner reflectors now available is about 5000 ft. The maximum range is reduced by rough seas.

Fixed radar beacons (Sec. 1-9) and Gee and Loran (Secs. 2-9 and 2-10) can be used for drift and ground-speed measurement by taking two fixes some distance apart and making the usual calculations. This method is preferable because it provides absolute fix data in addition to drift and ground speed. Except in the case of Loran, however, it is limited by the short range of the fixed stations.

3-6. Information Available on Flights over Water.¹—In overwater flight, the value of radar equipment may be seriously limited by the shortage of targets.

Landfall.—It is evident from the discussion on landwater boundaries in Sec. 3-1 that landfall can be easily determined by radar. This information is extremely valuable for air navigation near a coast line or over regions containing islands.

Surface Vessel Detection.—The radar returns from ships are usually very strong and stand out vividly as spots or short arcs on a PPI against the dark background of water areas. In Fig. 3-16*b*, several ships may be seen along the Massachusetts coast south of Boston. They are en route between Boston and the Cape Cod Canal. Additional ships may be seen in Buzzard Bay, south of the canal.

Even very small vessels, such as life boats, can be detected at ranges up to 10 miles or more. This fact is of great value in sea-rescue work. Collapsible corner reflectors have been added to the equipment supplied with the life rafts carried by ships and airplanes. These reflectors considerably increase the radar detection range.

The Problem of Sea Return and Its Alleviation.—In the discussion of land-water boundaries in Sec. 3-1 it was stated that water areas tend to reflect the radar energy away from the radar antenna. This statement is strictly true only for a perfectly smooth water surface with no waves or

¹ By D. L. Hagler and G. A. Garrett.

spray. Such a surface would act as a mirror and would scatter only a negligible amount of energy. This condition rarely, if ever, exists in nature; some radar return, therefore, is to be expected from any large body of water.

This sea return appears as a bright area at the center of the PPI display. It tends to obscure desired signals and may even obliterate them, as shown in Fig. 3-16a, and thus it may be a limiting factor in the usefulness of a radar equipment.¹

Although the exact phenomena which cause the scattering of radar energy by a rough water surface are not completely understood, the principal factors involved have been evaluated. In general, the intensity is greater for heavy winds than for light winds and is greatest from the windward direction because the size and shape of the waves and the amount of spray near the surface of the water depend upon the intensity and direction of the wind. The maximum range at which saturated sea return is obtained may be twice as great upwind as downwind. The intensity increases with increasing angles of incidence from the horizontal. The intensity and maximum range at which it appears increase as the power output, antenna gain, and receiver gain are increased. Measurements made on a 3-cm set show that the maximum range of saturated sea return increases rapidly with altitude for the first one or two thousand feet, and then at a diminishing rate because of the variation in the angle of incidence.²

The available information on the effect of polarization on the intensity of sea clutter at 3 cm and 10 cm is given in Table 3-1. It is not very conclusive.

TABLE 3-1.—POLARIZATION GIVING LEAST SEA RETURN FOR GRAZING INCIDENCE
Angle between beam and the surface of the sea less than 5°.

Wavelength, cm	Rough sea	Calm sea
10	No difference	Horizontal
3	Horizontal	Vertical

Range and azimuth resolution are also important factors. They are particularly significant when it is necessary to detect the presence of small craft within the clutter. The sea return at any one point on the indicator screen comes from an area on the surface of the earth of width equal to the radar beamwidth and of length corresponding to the distance light travels in half the duration of the pulse. The area of the water surface is usually

¹ E. W. Cowan, "Sea-return Effects and Their Elimination in the AN/APS-6,"
RL Report No. 707, June 11, 1945.

² Cowan, *op. cit.*

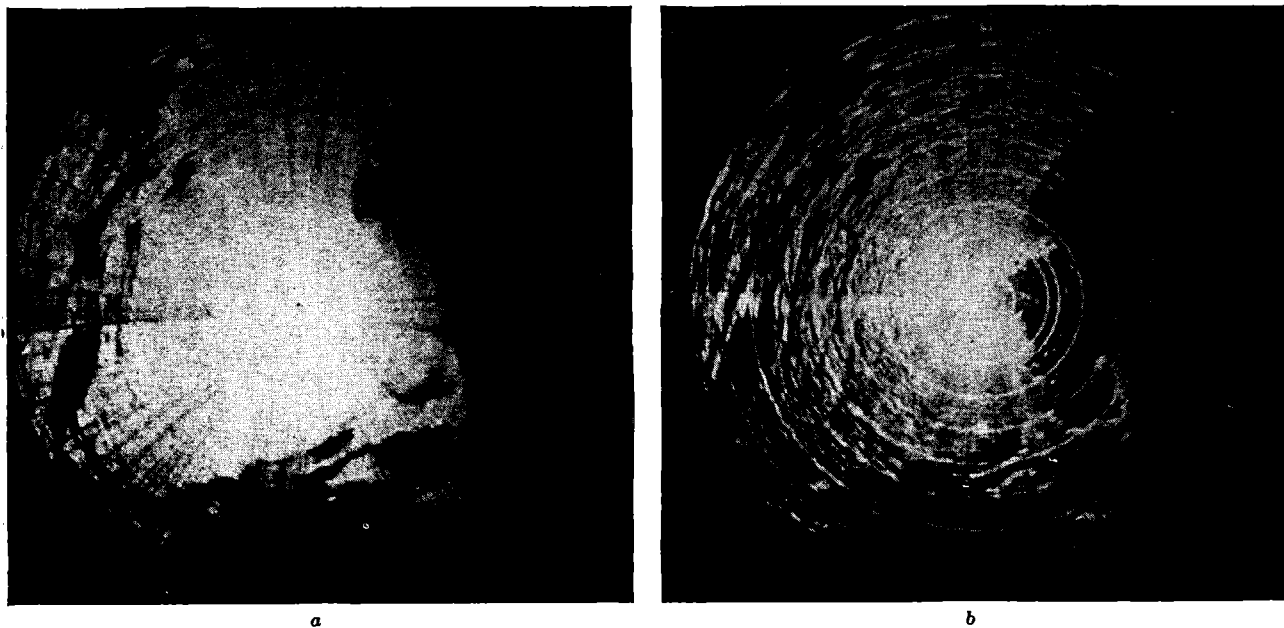

FIG. 3-16.—Two photographs showing the PPI (a) with a normal receiver, and (b) with a receiver having anticlutter circuits. High-power radar being flown near Boston, Mass.; 100-mile sweep length, 3° beamwidth, $2\text{-}\mu\text{sec}$ pulse.

large compared with this area of resolution and therefore intercepts the same total amount of radar energy regardless of its size. A small ship or a similar object, however, occupies an area which is small compared to this area of resolution. Thus, if the resolution of the radar set is improved, the ship will intercept a larger fraction of the total radar pulse energy and will therefore produce a stronger radar return without a corresponding increase in sea return. This increase in the ratio of desired ship return to sea return continues, however, only so long as the radar beam is wider than the ship or so long as the effective pulse length is greater than twice the width of the ship. Also, this discussion is based on the assumption that changes in beamwidth and pulse length are made without changing the total transmitted energy per pulse.

Several circuits have been found useful in minimizing the effect of sea return and are discussed in *Microwave Receivers*, Vol. 23, Chap. 10. All circuits accomplish their purpose by lowering the amplitude of the sea-return signal within the receiver to a value below the saturation limit so that other signals superimposed upon the sea return appear on the indicator. No one circuit is entirely satisfactory as a remedy for sea return, but certain combinations give great improvement. They are also useful in alleviating other types of clutter.

A striking pair of PPI photographs showing what can be accomplished by the use of anticlutter circuits is shown in Fig. 3-16. It is evident that many more ships (or possibly aircraft) can be seen and that Cape Cod is more clearly delineated when the anticlutter circuits are used.

Airplane Detection over Water.—The radar returns from other aircraft are detected more easily against the return from the ocean than against the stronger returns from land objects. The sea-return problems discussed in the above section apply to airplane detection as well as to the detection of objects on the ocean surface. This subject is discussed further in Sec. 4-2.

3-7. The Use of Maps as Aids to Radar Pilotage.¹—Radar navigation has been accomplished with the aid of only the conventional navigational maps. However, Air Force experience in Europe definitely proved that these maps were inadequate for easy navigation for two reasons:

1. They did not give all the information needed by the operator.
2. They provided a mass of useless, confusing information.

As a result, special radar-pilotage maps were prepared. The initial maps on the scale of 1-to-1,000,000 included detailed outlines of cities based on PPI photographs. In addition, they showed rivers, lakes, and railroads. These maps proved to be of tremendous help to navigators until the introduction of higher resolution equipment revealed certain

¹ By H. Fahnestock, Jr. and J. H. Buck.

undesirable limitations. For example, greater detail was needed in the outline of built-up areas, and light contour shading seemed necessary. In many respects, a 1-to-500,000 scale seems best for high-resolution radar, but this must be balanced, of course, by the amount of territory covered by any one map.

For any well-traveled route, a great deal of the bulkiness of maps can be eliminated by the use of strip maps. Preferably these should be sections of special radar maps cut so as to cover territory 25 to 50 miles on each side of the planned course. As an aid to the operator, pictures of the scope appearance at various positions along the course can be joined to the map at appropriate points. This is unnecessary if the radar map is well made.

A problem of the Troop Carrier Command, TCC, for example, was to navigate at night at altitudes below 1000 ft to a predetermined drop zone which was most often a small field. As an aid to such navigation, strip photographs leading from some prominent landmark to the drop zone were made in daytime from altitudes of 8000 to 10,000 ft. Positive transparencies were made from these negatives and dyed with a fluorescent dye. When viewed with an ultraviolet light behind them, these photographs were extremely realistic and showed land contours far better than most presentations. The films were placed on rollers in a box with a viewing window and an ultraviolet light behind the film. The rollers were geared to a variable-speed motor synchronized to the ground speed of the aircraft so that the picture in the window corresponded with the pilot's view of the ground.

A similar technique can be applied to a radar oscilloscope. Periodic photographs can be taken of a radar oscilloscope during reconnaissance missions flown with accurate navigation. The photographs can then be made into a strip and used in a manner similar to the TCC method, with the viewer set up adjacent to the radar oscilloscope. The navigator or pilot then directs the aircraft so that the picture on his oscilloscope corresponds to the reconnaissance strip. This has a distinct advantage over the visual photographs in that the maximum range shown by the photograph can be changed so as to be appropriate to the targets of greatest importance to the radar at the part of the trip in question. In some cases it might be desirable to show one or more beacons with the radar sweep set to 100 miles. The reconnaissance film could then have marked on it the fact that the radar sweep is to be set to 100 miles for that section of the film.

Similarly, the sweep could be changed as directed when the airplane approaches a coast line, a prominent river, or an airport. If desired, either electrical or optical means can be devised to superpose the reconnaissance (or, in the case of beacons, probably an artificial reconnais-

sance) on top of the picture of the targets being scanned by the radar. The aircraft would then be maneuvered to make the two coincide.

3-8. Radar Beacon Navigation.¹—A brief description of beacons is given in Sec. 1-9.² Ground beacons automatically transmit continuous information concerning their range and bearing to any aircraft interrogating them with a suitable radar system. Precise fixes may be determined and courses closely held by using the signals received from beacons. In addition, beacons help solve several special navigational problems.

Taking Fixes.—Because a beacon signal gives both range and bearing information, it is sufficient for a fix. The error of this fix is made up of bearing and range errors. At long ranges, errors in bearing are the greater because beacon signals usually cannot be read closer than about 1° . An angular inaccuracy of 1° at a range of 200 miles causes an error of 3 miles in position. The bearing error will also contain any inaccuracies of the compass reading used to convert relative to true bearing; these can be significantly large at long ranges or in rough air. Range errors are nearly independent of the range at which measurements are made and are usually less than 500 ft if readings are made on a short sweep.

Another possible source of error in obtaining range fixes is the use of slant ranges. The size of such errors here may be reduced by taking fixes only from beacons at ranges at least several times the altitude or by correcting the ranges graphically if they are taken from targets closer than this. This error is automatically eliminated, of course, if the radar sweep indicates ground ranges instead of slant ranges.

Because range can be read more accurately than bearing on most airborne radars, a better fix can be obtained with two beacons than with one. One intersection of the range circles gives the position of the aircraft. The fix error then is made up only of slant-range and reading errors. Very rough bearing measurements usually resolve the ambiguity arising from the fact that the range circles intersect at two points.

Course Indication.—Radar beacons can be used for holding any desired course within the area covered by a ground installation. If the ground stations are set up along an airway, a pilot using a radar scope can follow the beacon signals and steer directly by reference to the indicator screen. Homing is accomplished by keeping the signals from the beacon centered on the line on the radar scope that represents the course of the airplane. In the no-wind (or direct-head or tail-wind) condition this course line is the same as the heading line; otherwise these two differ by the drift angle, for which allowance is made in a radar system exactly as it is in the conventional radio compass.

¹ By T. H. Waterman.

² *Radar Beacons*, Vol. 3, contains detailed discussion of the uses and operation of beacons.

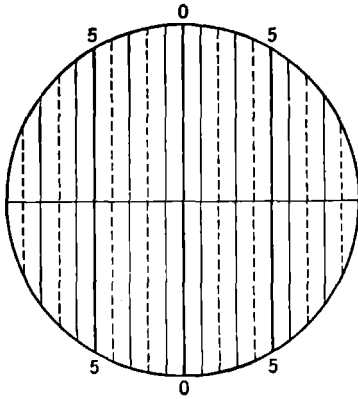

FIG. 3-17.—Course indicator for PPI with undelayed sweeps. Line 0-0 is the course line of the overlay. Distance between the paracourse lines is one-tenth of the sweep length.

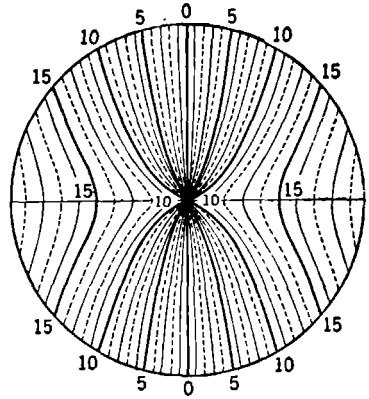

FIG. 3-18.—Course indicator for PPI with sweeps delayed by half the maximum range. Line 0-0 is the course line and the distance between the paracourse curves is one-tenth of the sweep delay.

Radar beacons may also be used in flying other than homing courses, if a course indicator is used on the radar scope. The indicator is a means of adding another coordinate system to the radar presentation; with it the operator can see whether or not he is on course and correct his heading accordingly.

The *course indicator* is a transparent overlay for the radar scope engraved with a series of lines that represent a set of equidistant parallel straight lines running in the same direction as the aircraft course and covering the area included in the scope presentation.

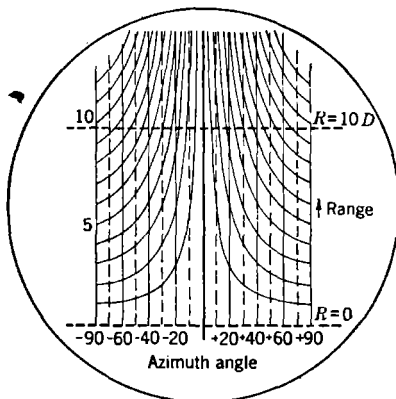

FIG. 3-19.—Course indicator for B-scope with undelayed sweep. When the line $R = 0$ coincides with the beginning of the sweeps on the scope, the distance between the paracourse curves is one-tenth of the sweep distance between $R = 0$ and $R = 10D$.

When a delayed sweep is used, the lines become distorted in the same way as do the geographical relations of the area covered. These two conditions are illustrated in Figs. 3-17 and 3-18, respectively. Figure 3-19 shows a course indicator drawn for a B-scope. The center line of the series is straight and represents the course of the airplane over the

ground. The rest of the lines are B-scope projections of imaginary straight lines parallel to the course of the airplane. For convenience they will be called *paracourse* lines. In addition to these, the overlay has reference lines in range and azimuth which permit it to be placed in the correct position on the face of the indicator tube. Any sweep lengths may be used with the transparency in Fig. 3-19, but expanded B-scope or delayed sweeps require other curves.

When a beacon signal or a search target moves down the radar screen along one of the paracourse lines, the airplane is flying a straight course which will pass the object observed at a perpendicular distance which can be read directly from the overlay.

The method outlined allows an airplane to use a radar beacon within horizon range for navigation directly to an airport where there is no beacon. It also offers a rough blind-approach system to any airfield which has a radar beacon located nearby in known relation to a particular runway. In general, such navigation can be used in cross-country flying when the desired course does not pass directly over beacons but does pass within horizon range of them.

As an example of the course indicator method of navigation, consider an airplane equipped with a 3-cm radar, which is to fly from Naval Air Station, Atlantic City, N.J., to Naval Air Station, Hyannis, Mass. (see Fig. 3-20). A course flown by radio-range airways between these two stations is about 40 miles (out of 270) longer than the most direct route which can be navigated with the help of a course indicator.

Five 3-cm radar beacons are in operation at sites near enough to the proposed course to be well within radar horizon range of an airplane at moderate altitudes. The airplane leaves Atlantic City climbing and on a magnetic heading of 63° . At 2500 ft (approximately over Tuckerton) the beacon at New York is picked up by the radar. Previous map study has shown that this beacon lies 37 nautical miles to the left of the desired course. Hence, when the airplane is on the right course, signals received from this beacon will center on an interpolated paracourse line 37 miles to the left of the course line. The beacon signal will continue to center about this line as long as the airplane stays on course.

The airplane, now at 8000 ft, picks up the beacon at Fishers Island at a range of 105 miles. This beacon lies 23 miles from the desired course and will move down the paracourse line 23 miles to the left of the course line. The beacon at Quonset Point will appear about 20 miles later. Its location on the scope should be on the paracourse line 20 miles to the left of the overlay center. The beacon at South Weymouth will be received 40 miles to the left of the course about 50 miles further on; a few miles later, the Deer Island beacon will come in 50 miles to the left.

In the foregoing discussion no mention is made of drift. The heading

and track of the airplane have been assumed to be the same throughout its flight. Unless the drift angle is taken into account, however, navigation by any direction-finding device, like a radio compass or a radar beacon, will result in a more or less spiral course. To avoid this in the present case, the center line of the course indicator must be displaced from the zero azimuth line of the radar scope by the amount of drift.

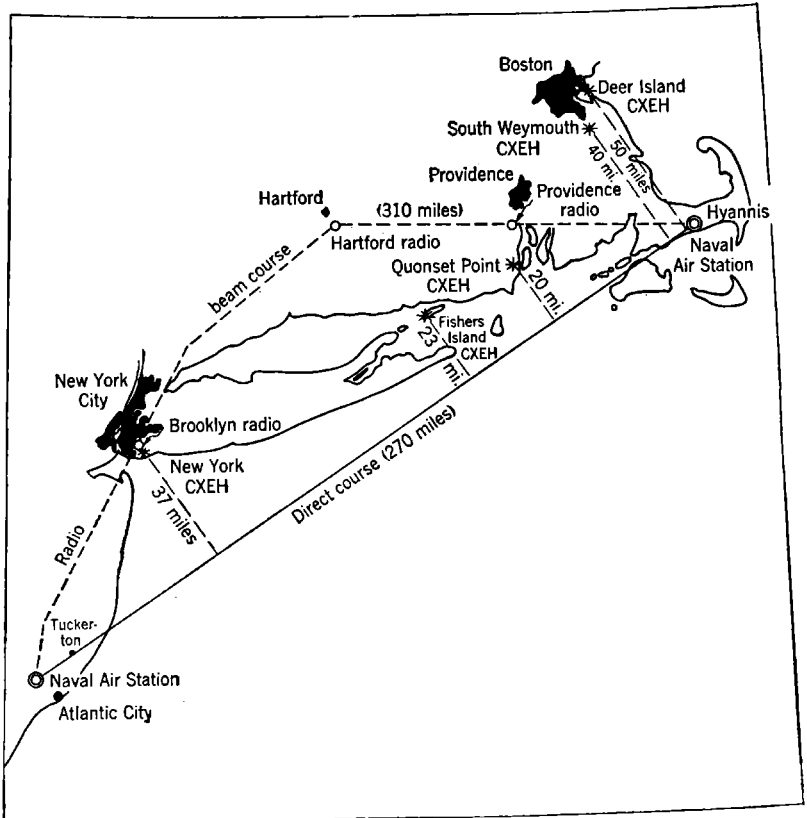

FIG. 3-20.—Map illustrating the flight made with course indication from radar beacons. This flight is described in detail in the text.

The reasons that these adjustments correct the navigation for drift are simple. The lines drawn on the course indicator represent relative motion of the airplane and ground beacons. Their center line coincides with the course made good by the airplane. The center line on the radar scope is coincident with the heading of the aircraft. When there is no drift, these two center lines should be super-

posed. When there is drift, the two center lines should be displaced so that the course line of the overlay is superposed on the azimuth line of the video which corresponds with the track of the airplane.

Fortunately the slant-range error is negligible for general navigation except at short ground ranges and high altitudes. At 10,000 ft or less, course errors resulting from slant-range effect will be less than 1 mile even when the airplane is almost over the beacon. For practical purposes, this factor may be safely neglected at low and medium altitudes. At high and very high altitudes only signals 25 miles or more in range should be used for course indication unless the distance of the beacon from the course is 10 miles or more.

Radar beacons could be used with course indicators in this way to set up parallel air traffic lanes. These would add a horizontal dimension to the present vertical stratification of air traffic. Such an application would permit the use of several air lanes on either side of a course marked by beacons.

Special Applications.—There are several special applications for which ground beacons might be used. For example, they could be used as aids in blind approach to airport runways. Several lightweight portable beacons already developed are suitable for this purpose. They could be mounted on trucks with their own power supply and moved from one runway to another as the need arose. Separate beacons could mark the ends of the strip, and additional equipment could be so located as to indicate critical turns in the let-down procedure. In an emergency, trucks with such beacons could be used to set up temporary navigational aids at auxiliary landing fields where no permanent setup exists. This application is discussed at greater length in Sec. 1-9.

Radar beacons in permanent installations might be valuable as anticollision markers for high obstructions near the airways, like particularly dangerous skyscrapers and mountains. A special type of obstruction marker would be an airborne beacon informing the pilot of the whereabouts of any other nearby aircraft. Airborne radar beacons have other uses and are discussed in more detail in Sec. 7-10.

Radar beacons can also be shipborne. Possible applications of this sort would include homing indication for aircraft employed in ship-to-shore mail transfer or other special services. Lightships may also prove to be useful beacon sites to aid aircraft navigating over continental shelf waters.

CHAPTER 4

SPECIAL AIDS AND DEVICES

BY W. J. TULL, R. H. MÜLLER, R. M. ROBERTSON,
AND R. L. SINSHEIMER

NAVIGATION AND ANTICOLLISION

4-1. The Ground Position Indicator.¹—A ground position indicator, GPI, is a device that continuously shows the position of the vehicle that carries it. The position is usually indicated either by latitude and longitude or by E-W and N-S distances from a point of departure. Information on the speed and direction of the vehicle is fed into the GPI continuously. It resolves the speed into components of velocity, multiplies the component velocities by the elapsed time to get the corresponding displacements, and adds these partial displacements to get the total displacements. These are automatically added to the coordinates of the starting point to give the display of the coordinates of position at any instant.

A GPI can be used only when means are provided for determining an initial fix and instantaneous values of ground speed and direction. The combination of a radar set, a true-airspeed meter, and a compass can provide all the necessary data for purposes of navigation. The GPI described in this section is one designed to be used in aircraft equipped with those three instruments. A GPI for some other vehicle might differ in minor detail but would be much the same in principle.

The GPI is made so that it will yield the following information:

1. The total distance traveled (given as two components of displacement).
2. The position of the aircraft relative to any landmark that gives a radar signal, obtained by setting an electronic index or crosshairs coincident with the radar signal.
3. The heading to be steered in order to follow a direct course to some desired destination.
4. The time that will be required to reach that destination if the prescribed course is flown.

An airborne GPI must be more complicated than one that would be used on a ship for two reasons: (1) the radar set measures slant range to

¹ By W. J. Tull, R. H. Müller.

the radar target; this must be corrected for altitude to get the corresponding distance from the point on the earth directly below the airplane to the target; (2) from the true-airspeed meter and compass, the components of the velocity in the air mass are readily computed but they differ from the components of the ground velocity by the amounts of the corresponding components of the velocity of the wind. Ocean currents produce similar but much smaller effects. The airborne GPI, then, must be so arranged that the components of the wind velocity can be determined and set in as a continuously operating correction.

The individual measurements which are to be set into the computer are described below.

Fix Determination.—The position of the aircraft is established by measurements of three quantities. They are the difference in altitude between the aircraft and the landmark, the slant-range or straight-line distance between the aircraft and the landmark, and the direction of the landmark relative to the aircraft.

The altitude H is set into the computer by making a range mark coincide with the first (nearest) radar signal appearing on the scope. This signal is assumed to come from a target almost directly under the aircraft. The altitude knob with which the range setting is made introduces the information into the computer.

The components of the fix mileage are adjusted until the crosshairs coincide with the reference signal on the PPI.

When these operations have been performed, it is possible to read from dials the altitude of the aircraft above the ground and its ground position with respect to the reference point. Ground position is represented in rectangular coordinates by two fix dials, one corresponding to X miles in the east-west, the other Y miles in the north-south, direction. The compass bearing of the landmark has been taken account of automatically by the GPI, into which the readings of the compass are continually fed. From this point on, all GPI computations are made in a plane parallel to the surface of the earth, the H factor being used only to convert slant-range radar data to GPI ground-range information.

Rate Determination.—The ground rate of the vehicle is determined by vector addition of the true airspeed and the wind speed. The GPI is made so that this vector addition can be made easily.

Suppose that the crosshairs have been set on a reference signal but that no correction for the wind has been put in. The crosshairs will then drift away from the reference signal with the direction and speed of the wind because the crosshairs are continuously shifted by the GPI only in accord with the velocity with respect to the air. If, however, the correction for the wind has been set in properly the crosshairs will remain in coincidence with the reference.

Wind correction is put into the computer by a simple process known as "memory point tracking." The operator sets the electronic index coincident with the landmark on the radar range scope, pushes a switch, waits until the index has drifted away from the reference by an appreciable amount, and then resets it on the landmark. The GPI then automatically computes and sets in the correct components of wind velocity that would have caused the marker to remain coincident with the radar signal. The computer has automatically taken two fixes, compared the components of true displacement and apparent displacement, measured the elapsed time, computed the components of the wind velocity, and set in the resulting values as a continuing correction.

Course Determination.—The course of the vehicle is set by placing the electronic index on the point over which it is desired to fly. This can be done in two ways. The first method consists simply of placing the index in coincidence with a signal, by a means involving the direct comparison of the relative position of the two as they appear on the radar scope. The second method performs the same function for points that do not appear on the radar scope. This method takes advantage of the knowledge of present position obtained from the GPI and the operator's ability to set the fix dials at desired future position numbers. Because the fix dials define the position of the crosshairs, they will appear in the correct position on the radar scope whether a radar signal is there or not, provided that the correct future position has been set on the dials.

With the crosshairs set on this point over which it is desired to fly, the computer will indicate both the change in heading and the time to go, which is necessary in order to reach the point in question.

Navigational Procedure.—The practice of GPI navigation has been made simple and permits accurate navigation with great facility. This procedure is outlined in four steps as follows:

1. Determine radar altitude.
2. Measure wind.
3. Set present-position dials to indicate position of aircraft.
4. Proceed with check-point navigation.

Steps 1 and 2 have been described. The fix dials indicate in north-south and east-west components the ground range and direction to any reference on which the crosshairs are set.

In Fig. 4-1 the fix dials (outer dials) show that the crosshairs are set on a point which is 18 miles north and 11 miles east of the aircraft. If the aircraft should proceed to this point the zeros of the fix dials will then have moved under the cursor, and on the PPI the crosshairs will have moved into the center of the oscilloscope. Clearly, the zeros of the fix dials may be thought of as representing the crosshairs. Now suppose

the crosshairs to be set on a reference whose mileage coordinates are known with the respect to home base. If the present-position dials then are turned until these mileage coordinates of the reference point lie opposite the fix dial zeros (crosshairs), the present position of the aircraft with respect to home base will be indicated on the present-position dials under the cursor.

In this example the crosshairs have been set on the PPI to a point which is known to be 118 miles north and 61 miles east of home base.

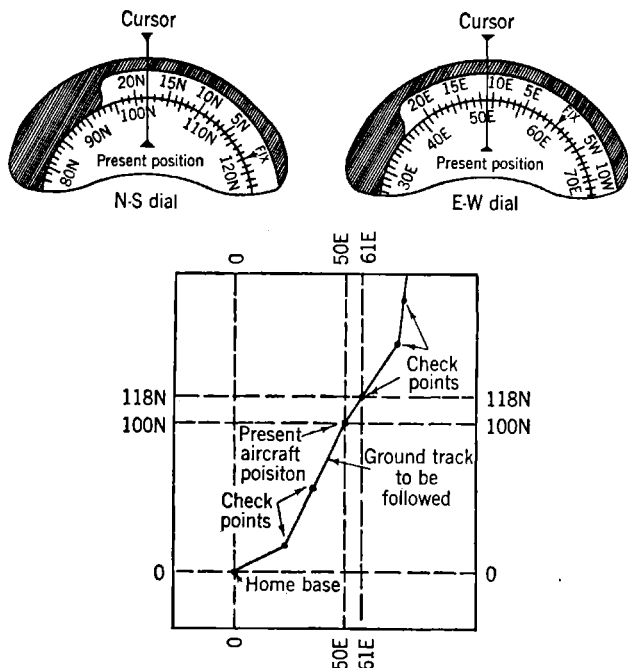

FIG. 4-1.—Ground position indicator, GPI. Present position and procedure for "check-point" navigation.

The fix dials indicate that this point is 18 miles north and 11 miles east of the aircraft. This means that the aircraft is $118 - 18 = 100$ miles north and $61 - 11 = 50$ miles east of home base. In Fig. 4-1 the present-position dials have been set so that the coordinates of the known point (118N and 61E) lie opposite the zeros of the fix dials. The present position of the aircraft is now indicated under the cursor on present-position dials. This constitutes Step 3 of the navigational procedure.

The "check-point" system of navigation is employed to indicate by means of the pilot's direction-indicator meter, PDI, the heading the

aircraft must follow in order to follow a given ground track. The mileage coordinates with respect to home base of any convenient point which lies on the desired ground track are selected by reference to an aeronautical chart or other source. This point is one over which the aircraft should pass in order to be on course (see Fig. 4-1), and it need not produce any radar signal. The fix dials are then turned until their zeros come opposite the mileage coordinates of the point in question. This operation places the crosshairs over this point on the PPI even though there may be no radar signal. If the function switch is now turned to the course position, the PDI meter will indicate a heading which is upwind from the desired ground track by an amount equal to the drift angle, and the TTG, time-to-go, meter will indicate the time in minutes before arrival at the selected point. This procedure of setting up check points for the GPI may be repeated until the aircraft arrives at its destination. If the aircraft has wandered off course during a time when the GPI may have been left unattended, the setting up of a single check point will bring it back to the prescribed ground track, and the use of a second check point will enable the aircraft to be turned on course. If the check-point system is used and if a new wind is found every time there is reason to believe it has changed, a predetermined course can be flown very accurately.

Identification of Radar Signals.—Radar signals appearing on a PPI tube can be identified by use of the GPI. One procedure would be to place the crosshairs on the unknown signal and then to read the mileage coordinates of that signal from the present-position dials opposite the zeros of the fix dials. By reference to a navigation chart showing these coordinates, the geographic location of the unknown signal can be found. Conversely, if it is desired to select one signal appearing among a number of other signals on the PPI, it is only necessary to set the fix-dial zeros opposite the mileage coordinates of the desired signal on the present-position dials. Then the crosshairs will appear over the desired signal on the PPI.

Classification of Reference Points for GPI.—The GPI technique divides reference points into three categories:

1. Principal references are those which, by nature of their shape or position relative to other signals, may be easily and positively identified by the use of radar with ordinary charts. It is not essential to use a GPI for these references. Principal references are used to set the present-position dials at the beginning of the navigational procedure. Since GPI is subject to a certain cumulative position error, the present-position dials will have to be reset occasionally. This may be done when the reference can be

positively identified by radar alone. It is very important that only principal references be used to set the present-position dials because in the absence of positive identification, the best information available is that stored in the GPI.

2. Intermediate references are those which appear as good radar signals but are not easily identified without a complete knowledge of present position. The use of GPI is very convenient in this case.
3. Local references are those which appear as small, weak radar signals. Many of these unidentified signals usually appear on the PPI. They can be picked up and identified by manipulating the fix dials to known coordinates of the reference and allowing the crosshairs to identify it on the radar scope. The destination of the aircraft may produce a signal of this type. If the crosshairs are set to the destination signal on the radar, the GPI will compute a very accurate estimate of arrival time.

In general, it should be stated that only some known discrete point of a reference should be used for fix or wind determination. The remaining larger portion of the reference serves only to aid identification.

Future GPI Techniques.—The descriptions and procedures in the preceding sections are concerned with a specific version of the GPI, which uses a rectangular coordinate system of computing and presenting data and requires an operator to judge when changes in wind make necessary a new computation of its component velocities. At this writing there are several new types of GPI in the design stage which treat these problems differently. One designed at Radiation Laboratory is expected, as a result of new techniques, to weigh only 35 lb in addition to the radar system.

Designs have been made that permit present position to be shown in latitude and longitude. Identification can also be made in latitude and longitude while the presentation of fix is given as miles from aircraft to reference. The major change that is made for a latitude-longitude presentation is multiplication of the east-west rates by the secant of the latitude of the north-south position in degrees.

It is desirable and comparatively simple to provide a system of counters and differentials in place of dials. There would be three sets of counters, one to give presentation of fix, a second to give present position of the aircraft, and the third labeled "Identification," to give the position of the crosshairs relative to home base. The counters would be used in the same way as the dials, but their presentation would be clearer.

Other refinements of the GPI will almost surely include continuously automatic altitude measurement. At this writing (1945), operatorless GPI's are being designed which solve continuously all problems of navi-

gation including the determination of drift angle. This type of GPI does not require a search radar but uses sonic or radar doppler principles, or beacons to obtain continuous data relative to ground speed and drift.

The accuracy obtainable with this equipment is about 5 per cent. A highly skilled operator can increase it to about 2 per cent.

The statements made herein have been concerned more directly with aircraft navigation; the GPI can be used very readily, however, for ship navigation or, for that matter, the navigation of any other vehicle. The GPI offers a convenient means for navigating since it supplies complete navigational information continuously and automatically, and requires little attention during flight.

4-2. Anticollision Radar Devices.¹—Collisions between two airplanes or between an airplane and a stationary object are rare but spectacular and disastrous. It can be expected that public opinion will be reflected in legislation requiring all possible measures for prevention of such accidents to be taken, and that much attention will be focused on airborne radar as a solution to the problem. Superficial consideration suggests that the objective of such measures should be a system that will give pilots "day-light" vision at night and in bad weather. The pilot should be able to "see" through fog and darkness with the help of radar.

Closer examination reveals tremendous difficulties in such a program. The complexities of scanning, presentation, and resolution appear to present insurmountable barriers to a realization of the popular ideal of the radar "eye." Other and simpler radar methods must be applied to the anticollision problem.

It is noteworthy that no specific radar system has yet been developed for anticollision work. Any development initiated now should be very carefully integrated into the entire air traffic control picture (see Chap. 8), and be considered carefully with regard to the known limitations of radar techniques. In particular, it would seem that, for prevention of collisions, most reliance should be placed on a general system controlled from the ground, rather than on adding more and more complicated equipment to the aircraft. In designing airborne anticollision equipment the emphasis should be on special situations which may arise despite generally adequate traffic control. Such equipment can be viewed as supplementary, designed with certain specific functions in view, rather than as an all-purpose system.

Minimum requirements for any anticollision system are: first, for the pilot to receive clear, unambiguous information of the approaching object in time to get out of its way; and second, for the pilot to be given sufficient directional information to know which way to turn. These requirements impose on the designer the necessity of providing adequate

¹ By R. M. Robertson.

radar range, directional sensitivity, and means for avoidance of confusion between important targets and undesired signals. The use of radar beacons will extend the range on targets of special interest and shows great promise in alleviating confusion of targets.

Anticollision Devices for Use over Land.—Two kinds of collision have to be considered, that between two airplanes and that between an airplane and a stationary object. In the crowded skies of the future, any attempt to make each airplane self-sufficient in avoiding collisions with other airplanes would lead to endless complexities of equipment. It can be expected that traffic will be rigidly controlled by ground control systems supplemented by airborne radio altimeters and, in some cases, by beacons and PPI navigational systems in the aircraft.

The pilot can always avoid stationary objects if he knows his own position and altitude and the position and height of nearby hills, mountains, and man-made structures. It would seem to be most important, therefore, to make sure that the pilot has access to such information. In mountainous areas outside of ground surveillance range, for example, a system of beacons used in conjunction with a PPI navigational radar would provide the necessary information. Further discussion of the use of airborne radar and beacons as a solution to the anticollision problem over land is given in Chap. 8.

Anticollision Devices for Use over Water.—A special problem is presented in the case of long-range overwater flights. The probability of collision is extremely low, but should one occur, it would be so disastrous that it is worth considerable expenditure to avoid even a one-in-a-million chance. Pilots on such flights usually desire considerable freedom in choosing their course and altitude. Hence, the obvious solution of channeling traffic is unworkable. The problem is made easier, however, by the fact that small private airplanes will not often be used, and that agreement as to standard equipment could probably be reached easily among the small number of major operators.

In this section, we set up a tentative list of requirements for such a system, and inquire briefly into how these requirements can be met. First, the pilots of two airplanes approaching one another at 400 mph should have at least three minutes' warning in order to avoid collision. Since the closing speed is 800 mph, a radar range of 40 miles is required to give the necessary warning. If both airplanes are flying very low, range will be limited by the horizon to a value considerably less than this, but this reduction in range will probably be compensated for by the fact that speeds at the lower altitudes will be less than maximum.

To achieve a radar range of 40 miles on large airplanes with present techniques requires equipment too large and heavy for practical use in the air. Ranges of 10 miles on bombers with radars (such as AN/APS-6

and SCR-720) designed for aircraft interception use in World War II were considered exceptional, and even then pronounced difficulties were experienced with sea return in all such systems. The components of AN/APS-6 are shown in Fig. 4-2. Ranges of 40 miles or more were obtained only with a system (AN/APS-20) which was too large and heavy for use in this application. The solution appears to lie not in attempting to improve the performance of radar systems to such an extent that they can be used alone, but in so adapting the radar beacon that it can be used with radar systems already in existence.

One way of doing this would be to require every aircraft to carry beacon equipment which would be interrogated by a sector-scanning PPI radar. Ranges of 40 miles or more could then be obtained. Problems

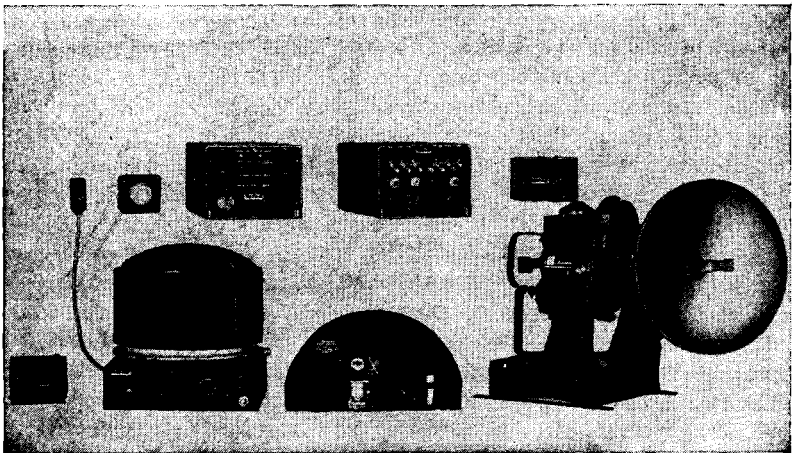

FIG. 4-2.—Components of AN/APS-6 system.

of sea return and cloud return can be eliminated by using beacons that respond at a frequency different from that of the radar transmitter (see Sec. 1-9).

The requirements for coverage in azimuth can be tentatively set at a 90° sector ahead of the airplane ($\pm 45^\circ$), and in height to ± 1000 ft. The height coverage can be obtained at ranges of 5 miles or more by making the vertical beam less than 4.5° high. Scanning is then unnecessary. Relative elevation information could be obtained by coding the beacon response or the response frequency to give altitude by means of a direct connection with the radio altimeter. Such an arrangement would require considerable development work, but has much to recommend it. For example, automatic warning by a bell or other means might be provided

when a signal is received that indicates an aircraft approaching at nearly the same height.

If accurate relative elevation could be obtained from the beacon response, the system would be simplified by having the aircraft change altitude to avoid an impending collision, instead of turning away from it. A convention might be established by which, for example, only east-bound aircraft would take evasive action by diving or climbing. Such a system would relax the requirement on azimuth directional information and might permit use of a simple nonscanning system.

ALTITUDE DETERMINATION

By R. L. SINSHEIMER

Radio altimeters determine altitude by measurement of the time required for radio energy to travel from an airplane to the earth and back. They provide an absolute measure of the clearance of the airplane above the terrain. Barometric altimeters, on the other hand, measure the altitude of the airplane above sea level. The accuracy of the height indication of a barometric altimeter rests upon two assumptions: first, that the observed atmospheric pressure on the ground beneath the airplane has not changed since the zero of the altimeter was last adjusted, and second, that the atmospheric pressure decreases at the assumed rate with increasing altitude. Because both of these assumptions are affected by meteorological fluctuations, the accuracy of barometric altimeter readings is also similarly affected.

Meteorological conditions, however, do not influence the accuracy of radio altimeters. Because these devices provide a rough profile of the terrain below the airplane, they can be used to a limited extent for navigation. For example, when an airplane crosses a coastline toward land, the altimeter indication will suddenly become slightly unsteady and fluctuate with variations of the terrain.

Methods for navigation over water which take advantage of the different properties of the radio and barometric altimeters have been devised. For example, fairly accurate measurements of crosswind can be obtained by utilizing the radio altimeter as a standard for observing changes in atmospheric pressure as shown on the barometric altimeter.¹ With this information it is possible to hold a more accurate course. This technique, however, is limited to overwater flights on which the radio altitude is the true altitude above sea level.

Two types of radio altimeters, one using the pulse technique, the other frequency modulation, are in common use. In the following sections

¹ AAF Board Report 3265B 413.44.

these are analyzed and one of each type described. The two radio altimeters discussed in this section were designed by the Radio Corporation of America.

4.3. Pulsed Radio Altimeter (SCR-718C). *Principles.*—This discussion of pulsed altimeters is confined to general principles and illus-

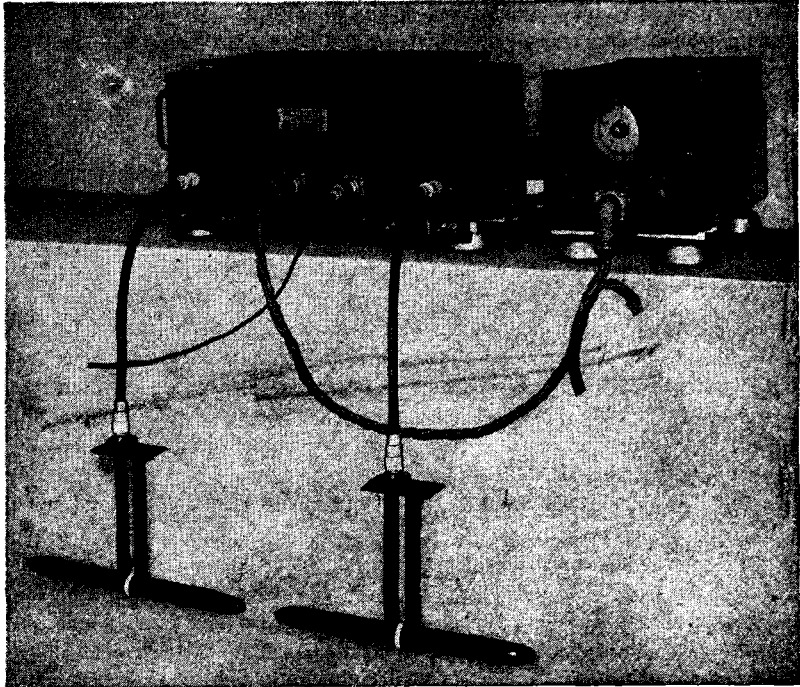

FIG. 4-3.—Components of pulsed radio altimeter, SCR-718C. (Courtesy of Radio Corporation of America.)

trated by the most recent version of this type, SCR-718C (see Figs. 4.3 and 4.4).

The time that elapses between transmission and return of the pulse of radio energy is measured by a method similar to those described in Sec. 1.8. The pulses are sent out and received at regular intervals at a rate of many thousands per second. An electron beam is started clockwise around the face of a cathode-ray tube at a constant angular rate in synchronism with each transmitted pulse. The beam is so timed that it is back precisely at its origin at the time of the next transmitted pulse. The transmitted pulse, and the echo pulse when it returns, deflect this beam radially in such a way that each produces a lobe, as shown in Fig. 4.5. The beam

leaves a visible trace on the face of the tube. The repetition rate is so high that the image does not flicker.

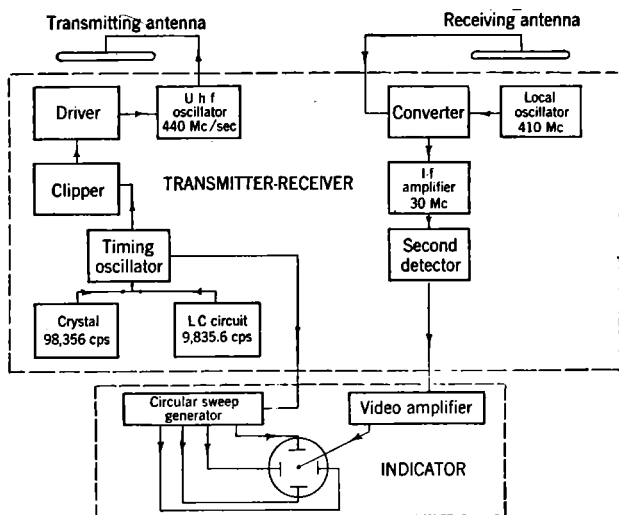
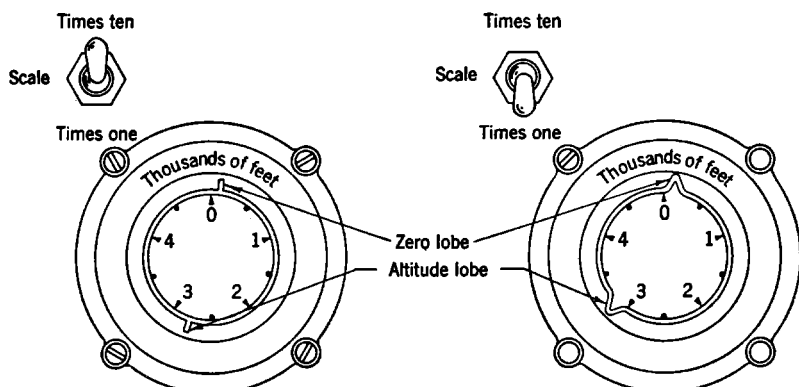

FIG. 4-4.—Block diagram of SCR-718C.



Switch in "times ten" position. Altitude lobe approximately between 25,000 and 30,000 ft.

Switch in "times one" position. Altitude lobe at exactly 3100 ft (sixth revolution). Exact altitude is $25,000 + 3100 = 28,100$ ft.

FIG. 4-5.—An SCR-718C altitude presentation. (Courtesy of United States Army.)

The angular separation between the transmitted and received pulses, or lobes, is thus directly proportional to the altitude of the airplane. A circular scale calibrated in feet is placed in front of the cathode-ray tube

in such a way that the zero is at the leading edge of the transmitted pulse and the scale reading at the leading edge of the echo pulse is the altitude.

On the low-altitude range of SCR-718C, 98,356 pulses are sent out each second. The electron beam must travel around its circular path in $\frac{1}{98,356}$ sec or 10.167 μ sec. This is precisely the time required for a pulse to travel to earth and back, if the airplane is at an altitude of 5000 ft. Hence, the circular scale is calibrated at 50-ft intervals from 0 to 5000 ft, and the reading opposite the leading edge of a return pulse is the aircraft altitude—if the aircraft is below 5000 ft.

If the aircraft were at 7500 ft, the ground signal would appear at a reading corresponding to 2500 ft because the electron beam continually retraces its circular path, and this reading would be ambiguous. Provision is made, however, for measuring altitudes up to 50,000 ft without ambiguity. The repetition rate of the radio altimeter is switched to one-tenth its previous value and simultaneously the electron beam is made to move around the face of the tube at one-tenth its previous speed. The same altitude scale may then be used by simply assigning ten times the previous number of feet to each scale division.

The accuracy of altitude measurement on a scale so compressed is necessarily poor. The proper operational technique with this altimeter, therefore, is to use the higher altitude scale only to locate the aircraft within a particular 5000-ft zone and then to switch to the low-altitude scale to measure accurately the altitude increment within that zone. By adding the reading on the 5000-ft scale to the nearest smaller multiple of 5000 ft, as observed on the high-range scale, the altitude of the airplane can be accurately measured (see Fig. 4-5).

Characteristics.—The pulses used in the radio altimeter described above are of 0.2- to 0.3- μ sec duration and the pulse power is 10 watts. A radio frequency of 440 Mc/sec is employed. The beamwidth is very broad because half-wave dipoles are used as antennas. Separate antennas, located on the underside of the airplane, are employed for transmission and reception.

The return signal is always very weak and must be amplified before it can be used to deflect the electron beam. After conversion to an intermediate frequency, the signal is amplified and converted to a video signal in much the same way as in an ordinary radar.

The SCR-718C weighs $24\frac{1}{2}$ lb, exclusive of cables and brackets, which for most installations weigh between 10 and 20 lb. The power requirement is 135 watts at 115 volts at any frequency from 400 to 2400 cycles.

The actual high-altitude limit of this equipment is 40,000 ft in an unpressurized airplane, because arcing in the high-voltage components

will damage the set at higher altitudes. At the other extreme, overlapping of the transmitted and received pulses and the inaccuracies mentioned below make readings at altitudes below 50 ft valueless.

The accuracy is dependent upon such heterogeneous factors as the time of rise of the transmitted pulse, the bandwidth of the i-f and video amplifiers, the accuracy of the pulse-repetition rate, and the fineness of the scale calibration. Of these, the first two are usually the limiting factors which determine the ultimate accuracy because it is necessary to estimate the position of the leading edge of the pulse. If we assume, for a moment, that the leading edge of the transmitted pulse is very steep, then the rate of rise of the received pulse as seen on the cathode-ray tube is determined by the half-bandwidth of the i-f amplifier or by the video bandwidth, whichever is the smaller. It is probably possible to estimate the position of the leading edge of the pulse with an accuracy in time of $\pm 1/10\Delta f$, where Δf is the bandwidth. In SCR-718C, Δf is approximately 2 Mc/sec so that this uncertainty gives rise to an error of ± 0.05 μ sec, or ± 25 ft of altitude. Because the small scale divisions represent 50-ft increments (for the 0-to-5000-ft scale) it is difficult to read the position of a pulse to closer than 25 ft.

The stability of the pulse-repetition rate is important because a fixed scale of calibration which assumes a particular period for each revolution of the electron beam is used. If the repetition rate, and consequently the time of revolution of the beam, varies, the calibration is no longer correct. This potential source of inaccuracy is minimized, however, by the use of a crystal-controlled repetition rate on the lower range scale. Such extreme stability is not needed on the high-range scale, because it is used only to locate the 5000-ft zone in which the airplane is flying. The repetition rate on the high range must not drift appreciably, however, or confusion will result upon shifting from high to low range.

In addition to these intrinsic errors, the pulse altimeter is also subject to a functional inaccuracy known as the "mushing error" which arises from the correction for the residual altitude (the apparent altitude when the airplane is actually on the ground). Its magnitude varies with the altitude of the airplane. Because it is small compared with the errors just mentioned, detailed discussion is reserved for the following section on frequency-modulated altimeters.

The pulsed altimeter is also subject to the usual operational inaccuracies, particularly in the matter of setting the reference transmitted pulse opposite the zero of the calibrated scale.

As a result of these combined intrinsic and operational characteristics, the error of SCR-718C is, at all altitudes, considered to be not greater than 50 ft + 0.25 per cent of the altitude. This error, therefore, is not greater than 62.5 ft at 5000 ft or 100 ft at 20,000 ft.

Since the fundamental timing unit is crystal-controlled, very little calibration is required. Maintenance therefore consists primarily of maintaining adequate power output and receiver sensitivity to provide an

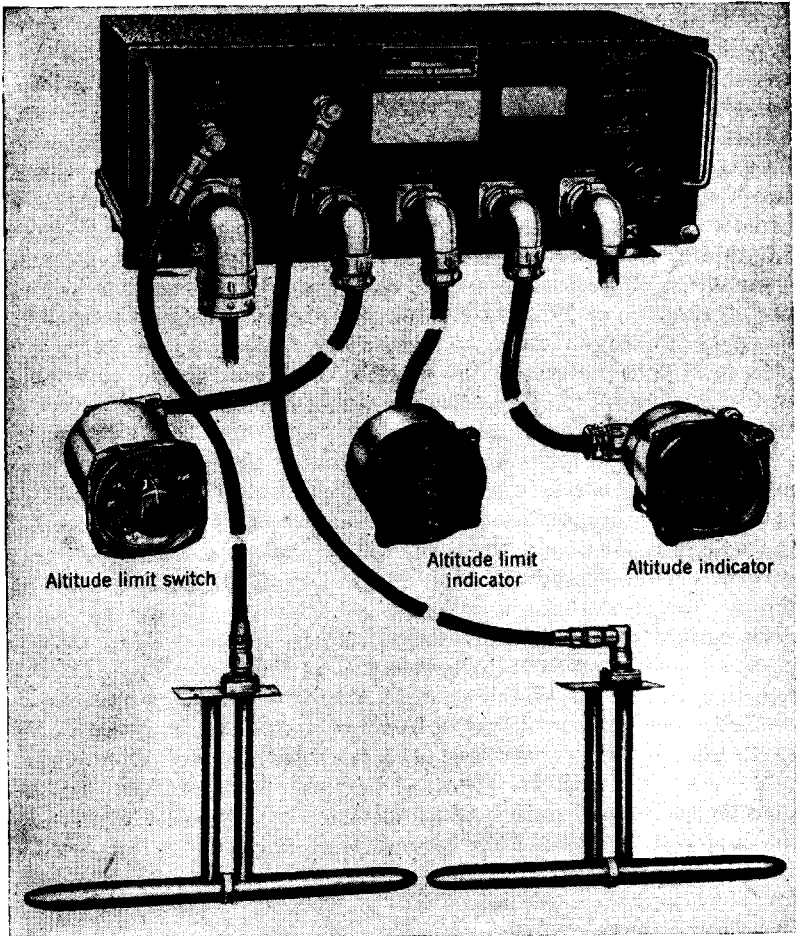

FIG. 4-6.—Components of f-m radio altimeter, AN/APN-1. (Courtesy of Radio Corporation of America.)

easily detectable signal at high altitudes. All units are independently replaceable without internal adjustment.

4-4. Frequency-modulated Altimeter (AN/APN-1). Principles.—

The f-m radio altimeter (see Figs. 4-6, 4-7), like the radio altimeter just discussed, measures the altitude of the airplane by determining the time

required for a radio wave to travel from aircraft to earth and return. However, a different method of time measurement, which depends on the observed difference in frequency between the transmitted and received energy, is employed. If the frequency of a radio transmitter is varied rapidly at a constant rate, the transmitter will change frequency in the time required for a radio wave emitted by it to travel to earth and return. The higher the airplane, the longer the time required for the round trip and the greater the difference between the transmitter frequency and that of the reflected wave when it arrives at the airplane. This frequency difference then is directly proportional to the altitude of the airplane. If the rate at which the transmitter frequency varies is known, the

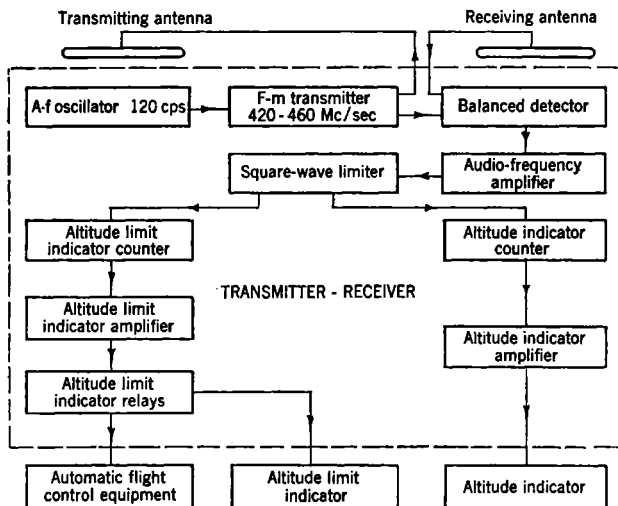

FIG. 4-7.—Block diagram of AN/APN-1.

elapsed time corresponding to any observed frequency difference is established. Because this is a direct measure of the altitude a circuit which provides a current proportional to the frequency difference can operate a meter which may be calibrated in terms of absolute altitude (see Fig. 4-8).

For low-altitude operation (0 to 400 ft), the frequency of a radio transmitter is varied sinusoidally between 420 and 460 Mc/sec at a rate of 120 times per sec.

For simplicity of design, sinusoidal variation of frequency is employed rather than linear variation. This variation does not affect the basic principle of operation because it can be shown that the average frequency difference over a cycle of sinusoidal modulation is equivalent to that obtained from a linear variation of frequency with the same modulating

period. Because the indicator circuits average the frequency difference over many modulation cycles, the transmitter may be considered to be frequency-modulated at a constant rate of 40 Mc/sec in $\frac{1}{240}$ sec (one-half cycle of the modulating frequency).

The output of this transmitter (about 0.1 watt) is radiated from a half-wave dipole transmitting antenna located on the underside of the airplane. A part of the reflected energy returns to a separate receiving antenna which is also located underneath the airplane but at some distance from the transmitting antenna.

If B is the total spread of the frequency modulation and f_m is the modulating frequency, then the change in frequency Δf of the oscillator

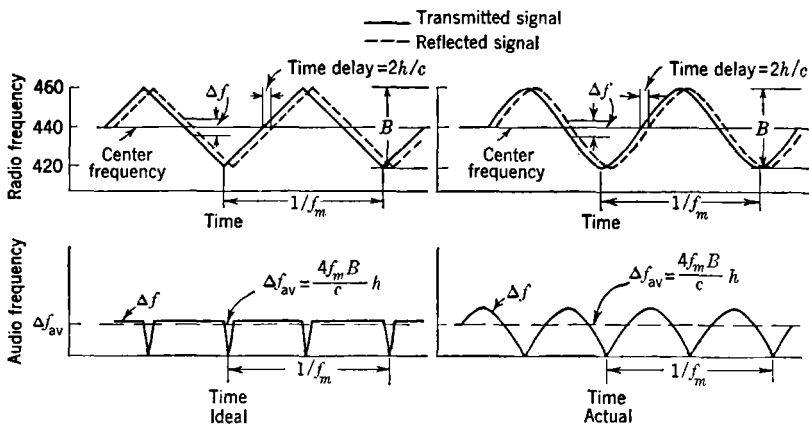

FIG. 4-8.—Frequency-time relations in AN/APN-1 (low range).

in time t is $\Delta f = Bt / \frac{1}{2f_m}$. In time t the radio wave will travel a distance $d = ct$, where c is the velocity of electromagnetic radiation— 98.4×10^7 ft/sec.

Since d will be twice the altitude h ,

$$d = 2h = ct$$

or

$$t = \frac{2h}{c},$$

hence for any altitude h

change of frequency = rate of change of frequency \times time for signal to travel distance h and return,

$$\Delta f = \frac{B}{1/2f_m} \times \frac{2h}{c}$$

or

$$\Delta f = \frac{4f_m B}{c} h.$$

On the low-range scale of AN/APN-1, $f_m = 120$ cycles, $B = 40$ Mc/sec, so that Δf will be 19 cycles per foot of altitude.

A signal frequency f_Δ , equal to the difference in frequency of the transmitted and reflected waves, is derived by mixing in a balanced detector a fraction of the transmitter output with the reflected wave, as picked up on the receiving antenna. An audio signal of average frequency equal to 19 times the altitude in feet is obtained from this detector.

The actual instantaneous audio frequency varies periodically as shown in Fig. 4-8. It even goes to zero every time the oscillator frequency and that of the reflected wave become equal (twice every cycle); as previously mentioned, however, the indicating circuits average the signal frequency over many modulation cycles.

This signal is amplified in the audio amplifier to a value equal to the limit level. The output consists of pulses, one for every cycle of the audio signal. These pulses then operate a counting circuit which generates a current proportional to the number of pulses per second. This current passes through a meter which provides the altitude indication.

In order that the difference frequencies shall not become too high for the pass band of the audio amplifier, when the high-altitude scale (0 to 4000 ft is used) B is reduced by a factor of 10 to 4 Mc/sec. Thus f_Δ is reduced to 1.9 cycles per foot of altitude. An audio frequency now corresponds to ten times its previous altitude. Since the indicating circuit is virtually unchanged, the same indicating meter can be used merely by multiplying the scale by a factor of 10.

Separate circuits are provided for the attachment of an altitude limit indicator with three lights ("Above Altitude," "At Altitude," "Below Altitude") for a pilot who wishes to fly at a fixed altitude. These circuits can, if desired, be tied in to the automatic pilot to provide automatic control of the aircraft altitude.

Characteristics.—AN/APN-1 weighs $24\frac{1}{2}$ lb exclusive of cables and brackets, which may weigh anywhere from 10 to 20 lb depending upon the installation. The altimeter requires 70 watts at $27\frac{1}{2}$ volts, DC.

Because of design considerations, the 0-to-4000-ft range scale must not be used below 400 ft. The low-range scale cannot be used as a vernier to the high-range scale as it is in the pulsed altimeter.

Two sources of error are inherent in AN/APN-1: one is the so-called "fixed" error and the other the mushing error.

The source of the fixed error lies in the pulse-counting method of obtaining a current proportional to altitude. The number of pulses per

second from the limiter circuit, and hence the current which produces the indication, must increase only in steps corresponding to the number of modulating cycles per second. Thus the output of the limiter circuit must increase in jumps of 120 pulses. Because 19 pulses correspond to 1 ft of altitude, the altitude indication must increase in intervals of 6 ft.

In actual operation, however, the terrain and the flight of the aircraft are usually not smooth enough for this error to be significant. On the high-range scale, however, the output of the limiter circuit still increases in steps of 120 pulses and each pulse represents 1/1.9 ft. Consequently the altitude indication is varied in steps of 60 ft.

If either the modulation frequency or the radio frequency were changed, the fixed error would remain constant because any change on the step increment of audio frequency would produce a counterchange

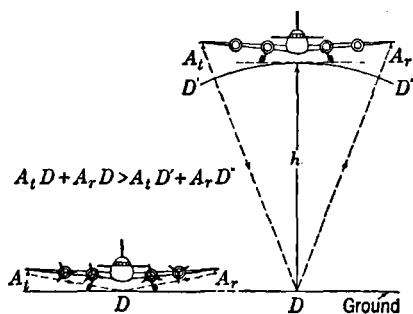

FIG. 4-9.—Geometric quantities involved in the mushing error.

in the altitude differential corresponding to each audio cycle. The altitude equivalent of each step is expressed by the relation

$$\Delta h = \frac{c}{4B} = \frac{246}{B} \text{ ft,}$$

if B is expressed in megacycles. Thus, the only way to decrease the fixed error is to increase the frequency deviation.

The second source of inherent error, the mushing error, is significant at low altitudes. It is caused by the fact that the transmitting and receiving antennas are mounted some distance apart on the airplane. It is evident from a study of Fig. 4-9 that at high altitude the total path from transmitter to receiver is the sum of the following distances: transmitter to the transmitting antenna and from the receiving antenna to the receiver, plus $A_t D'$, plus $A_r D''$, plus $2h$. As h decreases, $A_t D'$ and $A_r D''$ increase, until, at very low altitudes, they become comparable to the altitude itself. There is still a residual altitude when the airplane is on the ground, because of the path length in the cables plus $A_t D$ and $A_r D$.

As a result of this residual altitude an audio-frequency signal is developed in the altimeter when the airplane is on the ground. Because the altimeter should read zero under such circumstances, it is calibrated to read zero when this audio frequency exists. At medium and high altitudes, however, since $A_i D + A_r D > A_i D' + A_r D''$, this zero set correction is too great and the altimeter will read low. Within the low-altitude range, this error is minimized by altering the proportionality between the indicating meter current and the audio frequency developed, so that the meter reads correctly at 300 ft as well as on the ground. Between 0 and 300 ft, this effect can cause the altimeter to read low by as much as 5 ft in some installations.

In addition to these inherent errors operational errors, arising from drift of calibration, temperature or supply voltage changes, and so on, also exist. As a result, the error of AN/APN-1 appears to be not greater than 5 ft + 5 per cent of the altitude on the low scale and 50 ft + 5 per cent of the altitude on the high scale. For a well-calibrated set, the altitude indication upon landing will most probably be within ± 5 ft.

AN/APN-1 appears to hold calibration very well for periods of at least a month. Special test equipment (TS-250/APN) is needed to calibrate it. If a transmitter-receiver unit becomes defective it can be replaced only by a unit calibrated for the same residual altitude. For a known installation this can be done at a test bench.

4-5. Comparison of F-m and Pulsed Altimeters.—It is evident that the f-m and pulsed altimeters, as they are designed at present, are intended for different purposes. The f-m unit has a very small fixed error; the pulsed altimeter has a negligible percentage error. Both measure the true clearance above the surface, but the f-m type is intended for very accurate height measurement at low altitudes, and the pulsed type is intended for less precise measurement up to very high altitudes.

Each type performs its particular function well, but each could, at least in principle, be adapted to serve both purposes. The f-m type could be extended to higher altitudes without sacrifice of accuracy by the use of a wider audio amplifier band and greater power output. Correspondingly, the accuracy of the pulsed type could be increased by the use of a shorter pulse (with appropriate increases in i-f and video bandwidth) and a shorter range scale for low-altitude measurement (perhaps a 500-ft scale).

The two types have very similar weight and power requirements. If no a-c supply is available, however, an inverter would be necessary to furnish power for SCR-718C. The wartime cost of SCR-718C was \$700 while that of AN/APN-1 was only \$415.

The necessity for careful calibration of AN/APN-1 means greater difficulties in maintenance than in the case of SCR-718C. In addition, as noted above, AN/APN-1 transmitter-receivers are not readily replaceable unless similarly calibrated units are available. The meter presentation of AN/APN-1 seems definitely preferable to the cathode-ray tube presentation of SCR-718C. The latter must be observed in reasonably dim light, whereas the meter can be placed in the cockpit dashboard.

4-6 Suggested Future Trends.—A single device with the range of the pulsed altimeter and the low-altitude accuracy of the f-m altimeter would be a desirable improvement for future development. Meter presentation for the pulsed altimeter could certainly be achieved by adoption of any of a variety of existing range-tracking techniques, with little increase in weight.

If future applications require a decrease in the fixed error of the f-m altimeter, an increase in the operating frequency would become desirable to permit the necessarily wider frequency deviation. In any shift to a higher frequency, however, the radiated beam must not be made too narrow or indications will be lost during banking or will be false during steep climbs or dives. Sharper beams than are used at present, however, would afford more accurate altitude information over rough terrain.

CHAPTER 5

SPECIAL DESIGN CONSIDERATIONS

BY D. HALLIDAY

Experience with airborne radar systems has shown that the simplicity of operation obtained by the reduction in the number and complexity of controls nearly always results in improved usefulness. Nevertheless, it is often desirable to provide the operator with special devices or facilities which may be extremely valuable under certain restricted operating conditions, although they are not essential. The radar designer must evaluate the need for all special attachments and controls, balancing their usefulness against weight, power, and space limitations. No exact rules can be given because much depends upon the intended use of the radar system. This chapter describes some of the extra design features that are often desirable, and discusses special receiver, indicator, and antenna problems associated with the design of airborne radar equipment.

5-1. Receivers. *Automatic Frequency Control, AFC.*—Probably no other nonbasic design feature is so desirable as AFC which keeps the radar receiver continually and automatically tuned to the frequency of the transmitter. Commercial airborne radar receivers will almost certainly incorporate it. AFC makes it possible for the receiver to follow extremely rapid fluctuations in the frequency of the transmitter, caused by reflections of the radar pulses from the scanner housing or other parts of the aircraft structure and usually synchronized with the rotation of the scanner. Such detuning is much more rapid than detuning caused by changes in pressure and in the temperatures of certain components of the radar system during search operation.

Two electronic AFC devices are commonly used for search and beacon operation. In search operation the technique is to divert a tiny fraction of each transmitted pulse into a circuit that measures the frequency. The electrical output of this circuit is used to alter the receiver tuning from pulse to pulse in order to keep it tuned at all times to the transmitter frequency. Because a tuning correction is given by each pulse, the frequency to which the receiver is tuned is corrected hundreds of times per second.

A special difficulty arises in beacon operation because the transmitter to which the radar receiver is to be tuned is located elsewhere—in the

beacon. Direct sampling of its frequency is impossible. Instead, a carefully constructed small hollow metallic cavity is installed as part of the beacon AFC equipment in the aircraft. It is resonant at a precisely chosen reference frequency. Circuits are arranged to keep the local oscillator of the receiver tuned to the frequency of this reference cavity. The frequency of the transmitter of the ground-based beacon is held constant with the aid of a similar reference cavity, the two frequencies differing by an amount equal to the intermediate frequency of the receiver.

During beacon operation, AFC is most useful in the initial pickup at long range. Beacon AFC usually permits instant pickup of the signal, whereas minutes might be required to find it by manual tuning because of the need for scanning. Once the signal has been observed, moreover, there is freedom from detuning caused by temperature drifts of the radar system.

Under conditions of perfect radar maintenance AFC should eliminate the need for any manual tuning control. Experience has demonstrated, however, that present AFC circuits are so temperamental that the manual tuning control must be retained and a switch provided to transfer from automatic to manual tuning when necessary.

Three-tone Provisions.—It was pointed out earlier that the navigator in an aircraft is interested in radar echoes from cities and other large targets as well as in the weaker but more extensive echoes from the ground itself. Under some conditions, he will use low receiver gain in order to accentuate the strong echoes from cities at the expense of those from the background of land. Sometimes he will use high gain to accentuate rivers, lakes, and other land-water boundaries. Because ordinary receivers and indicators do not allow clear distinction between the large echoes from cities and the almost equally bright background of ground clutter, a device is needed to increase the contrast so that both classes of signals are displayed to good advantage on the PPI at one gain-control setting. Such electronic devices are known as "three-tone" circuits, the three "tones" being (1) the dark-noise background, (2) the somewhat lighter signal level from ground reflections, and (3) the bright signals from cities and other large targets.

Figure 5-1 shows the advantage of using such a device. The improved contrast is apparent. These circuits also aid the recognition of detail within complex targets. Toward the close of the war, three-tone circuits were being installed as field modifications of many military airborne radars. Three-tone circuits are useful because echoes seem to fall into two fairly separate groups of weak signals and strong signals.

There are several methods for attaining three-tone display; the one described here uses two receivers differing in certain characteristics.

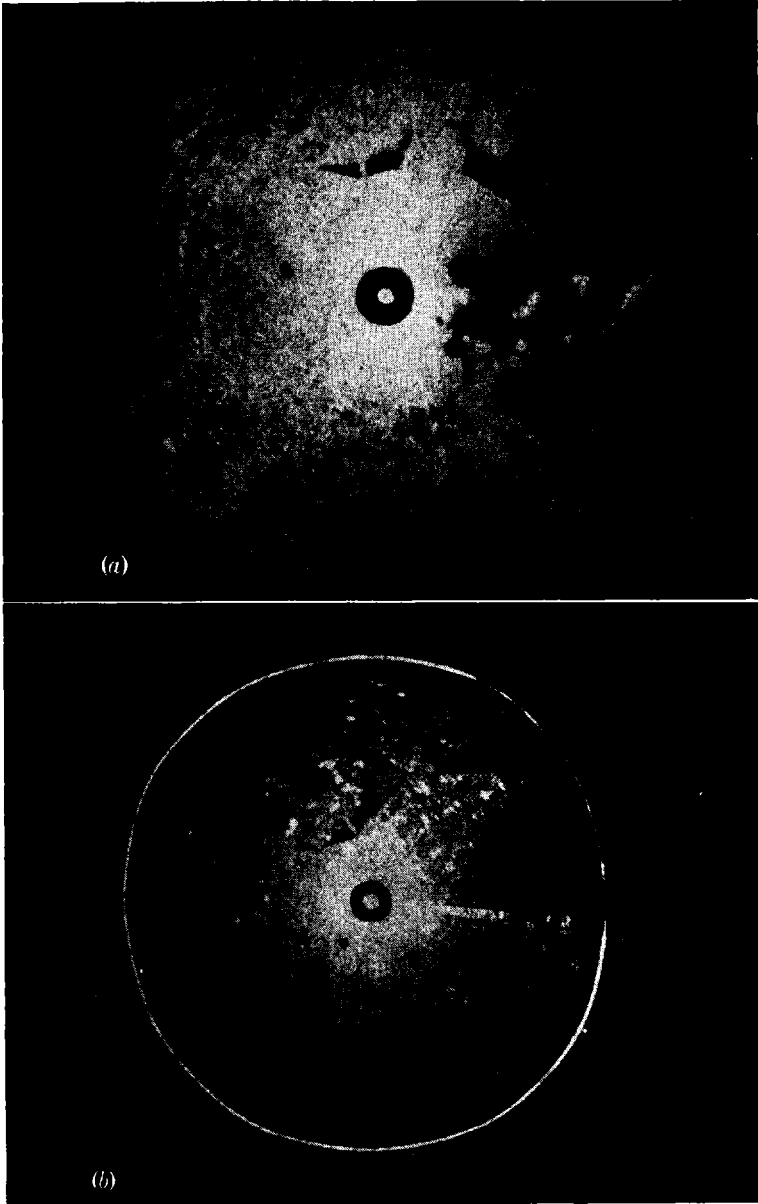

FIG. 5-1.—PPI photographs of the Boston, Mass., region showing (a) normal receiver operation, and (b) the use of three-tone device.

Actually, two identical receivers need not be used; one of them can be simple, requiring about five additional vacuum tubes.

The input circuits of the two receivers are connected so that all signals pass through both of them and the output video pulses are mixed and applied through one channel to the PPI. One receiver, which may be a very rudimentary one, has low gain but can deliver a large maximum output pulse. (It has a high video limit level.) The other receiver has high gain and low video limit level. Figure 5-2 illustrates the behavior of these two receivers. It is clear that they both respond to the strong city signals but that only the second receiver responds to the weaker background signals. The two outputs together produce a display similar to that of Fig. 5-1b. The gain controls of both receivers might be made available to the operator, the first being labeled "Signal Gain" and the second "Background Gain."

The two-receiver method is probably best when the three-tone pro-

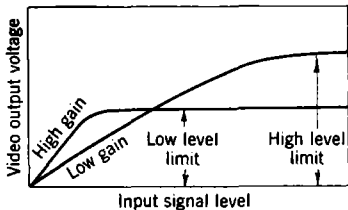

FIG. 5-2.—Three-tone receiver characteristics.

vision is to be included in a new radar set. Other circuits, however, are simpler to apply as attachments to existing sets. One commonly used device consists of a circuit arranged so that the gain and video limit level of the normal radar receiver are both periodically and simultaneously switched between two discrete adjustable values. With this switching

method, the sensitivity for small signals is inherently somewhat lower than with the two-receiver method because the radar receiver is in its high-gain position only about half of the time. For this reason the two-receiver method is to be preferred even though it does involve a greater number of tubes.

Sensitivity Time Control (Time-Varied Gain).—When targets of small radar cross section are being scanned by a radar system with a cosecant-squared beam, it is frequently possible to find a single setting of the gain control suitable for all portions of the PPI. When sea or ground clutter is present, however, this is not possible. If the gain control is adjusted to be optimum for seeing small targets in clutter at long range, the clutter signals at short ranges will often be strong enough to overload the receiver and mask nearby signals of special interest. This difficulty is more apparent with radar systems of good range performance. A remedy for this situation is sensitivity time control, STC, which has been mentioned in Sec. 1-2. It is an electronic arrangement for adjusting the receiver gain automatically immediately after each pulse. Figure 5-3 shows such a PPI display both with and without STC. The variation of gain with

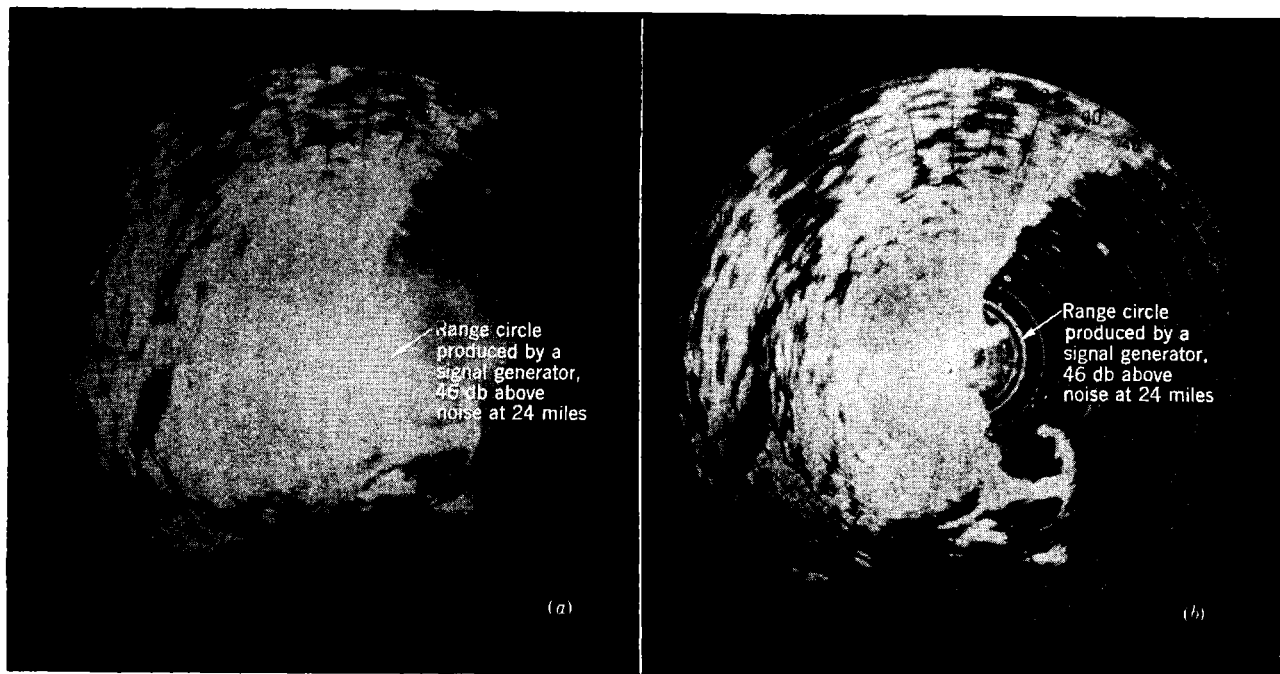

FIG. 5-3.—PPI photograph showing the effect of sensitivity time control. (a) STC not used. (b) STC applied; note signal generator circle now clearly discernible. Altitude, 10,000 ft; sweep length, 100 miles.

range or time for this particular STC circuit is shown in Fig. 5-4. Note that STC, as used here, requires additional controls and fairly skillful adjustment by the operator because different settings are required for each sea condition and usually for each sweep length. It is most useful when there is no appreciable variation of clutter with azimuth.

5-2. Indicators. Range and Azimuth Markers.—As mentioned in Chap. 1, there are several possible ways of determining range on the indicator. The simplest is direct measurement of distance from the start of the sweep by means of a suitably scribed transparent disk placed over the indicator screen. This mechanical method has been replaced largely by the use of electronic markers which appear as bright lines on the indicator screen. (Sometimes the lines are made dark.) The markers are relatively easy to produce electronically and are of two types, fixed and movable.

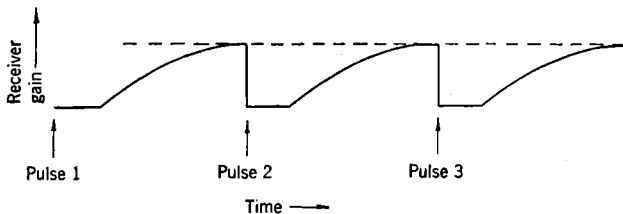

FIG. 5-4.—Receiver gain variation for STC.

Fixed range markers, appearing as circles on the PPI, are used for all ordinary navigational slant-range measurements in which an accuracy of 2 to 5 per cent suffices. Much greater accuracy can be obtained with a movable marker whose position is controlled by a calibrated dial. An absolute slant-range accuracy of 25 yd, independent of range, is possible when a fast sweep is used with such a movable marker. At moderate or large ranges such fast sweeps must be delayed.

The first method of measuring azimuth or bearing on a PPI involved use of a collar with scribed angle markings placed around the periphery of the tube. A rotatable transparent disk with a scribed radial line was used as an aid in sighting. The disadvantages of this method were due to parallax, zeroing errors of the circular scale, nonlinearity of the sweep and lack of centering, and errors caused by inherent azimuth distortions of the data-transmitting system. It was also difficult to apply to the off-center PPI. Similar azimuth-measuring techniques, with similar associated errors, exist for the type-B presentation. Nearly all of these sources of error can be eliminated by the use of electronic azimuth markers. Possibly because such markers are more costly in weight and power than are electronic range markers, they are only now coming into

common use on the PPI, although they have been used on type-B displays for some time. Calibrated azimuth markers may be made accurate to $\pm 0.25^\circ$.

Whenever a scribed transparent disk is used, parallax may be greatly reduced by the optical method illustrated in Fig. 5-5. As shown there, a virtual image of the marks on the underside of the illuminated disk is formed at or very near the light-sensitive screen of the PPI. This technique is particularly useful in marking, with a china pencil, the course of a particular signal across the indicator screen; it has been adopted as standard practice where 12-in. cathode-ray tubes are used. Although such large tubes are now commonly used in surface-based systems they are generally found only in the very largest aircraft.

Azimuth Stabilization.—A considerable aid to the radar navigator

is the type of presentation called "azimuth stabilization." Figure 5-6 shows a comparison of a normal display and an azimuth-stabilized display for an aircraft headed east (heading 90°) and scanning with its radar a target 30° from its heading.

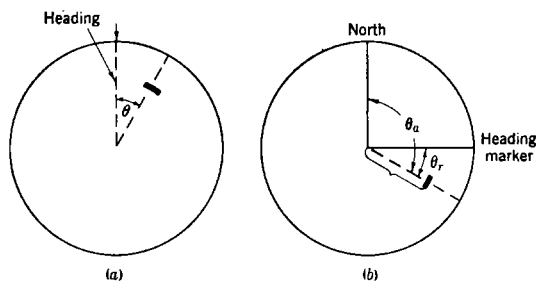

FIG. 5-6.—PPI displays for aircraft heading east, target 30° south of east. (a) shows normal presentation; (b) shows azimuth presentation when azimuth stabilization is used.

where $\theta_r = 30^\circ$ and represents the relative bearing of the target. Figure 5-6b shows an azimuth-stabilized display where $\theta_a = 120^\circ$ and is the absolute bearing of the target. In the latter case, the fiducial marker at the top of the tube may be made to represent magnetic north or, if

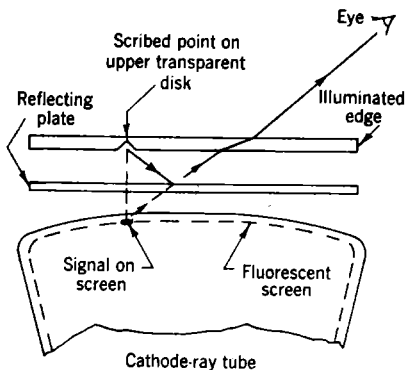

FIG. 5-5.—A method for reducing PPI parallax errors. Scribed point appears to be superimposed over signal on fluorescent screen.

the variation is known, true north, so that θ_a may be measured with respect to either.

If the aircraft heading changes, the pattern of Fig. 5-6a rotates through an angle corresponding to the change, but the pattern of Fig. 5-6b remains unaltered. Thus, comparison of the radar screen with a map is facilitated when azimuth stabilization is used because the map can automatically be held with north in the 12 o'clock position beside the indicator and does not need to be reoriented as the aircraft heading changes. It is also easier to use with overlays or map projection, a technique described in Sec. 9-5. In addition, erratic heading changes caused by rough air motions do not cause smearing of signals on the PPI. Azimuth stabilization has so many advantages that it was incorporated into nearly all military airborne radars installed in airplanes weighing 100,000 lb or more. It also promises to be a useful adjunct to commercial navigational radar.

With azimuth stabilization, the aircraft heading can be indicated on the radar screen. The indication usually takes the form of a bright radial marker flashed upon the screen at the proper azimuth angle (see Fig. 5-6b) once each revolution. This flashing marker may be initiated by a switch on the scanner shaft that is tripped once per revolution as the scanner is pointed dead ahead. Without such a marker, the heading can be determined, but much less conveniently, from a magnetic compass.

It is clear that a device for providing azimuth stabilization must have some connection with a magnetic compass. The instrument often employed as standard equipment is the Pioneer Fluxgate compass with a gyro-leveled sensitive element. In outline, the mechanism is this: the compass shaft, when it moves through a certain angle in response to a heading change, controls a motor that turns a rotation-sensitive component in the PPI sweep system through the same angle. Several sweep-circuit components have this rotation characteristic. One frequently used is the rotary transformer or "selsyn," the rotor of which is turned continuously by the scanner as it revolves. The stator, which is clamped rigidly to the aircraft frame when azimuth stabilization is not used, can be rotated by this compass-controlled motor, producing the desired sweep azimuth displacements. In azimuth-stabilization systems the servomechanism must be capable of a high speed of response to avoid blurring of signals on the PPI during rapid heading changes.

Importance of Good Range Resolution.—An important factor in the use of airborne radar is the short time available for examining the details of short-range PPI displays. At a ground speed of 400 mph the presentation displayed on a PPI with a 5-mile sweep changes completely within less than two minutes and there is little time for examining the details of a pattern or for making detailed comparisons with a map. Recogni-

tion of terrain features or built-up areas under such viewing conditions demands a very clear presentation with good resolution and freedom from distortion.

Of course, airborne radars are not always used to view such nearby objects. Sometimes it is preferable to "paint in" broad outlines of distant objects, which requires maximum range performance rather than high resolution. Because the same set is often employed for both short- and long-range service, there must be either some compromise or operational control of certain characteristics, such as the pulse length. The most recently designed systems have two pulse lengths for search use—0.5 μ sec when good resolution is required at close range, and 5.0 μ sec when maximum range performance and the mapping-in of extended land areas are desired.

Range Distortion.—In Sec. 3·1 it is mentioned that the presentation of slant range instead of ground range on the PPI may make it difficult to interpret radar information correctly. The following paragraphs discuss in detail the various aspects of this problem.

The relationship between slant and ground ranges (S and R , respectively) and the altitude h is given by $S = \sqrt{R^2 + h^2}$. For zero ground range, the slant range is equal to the altitude. Because the nearest ground target is usually the point directly below the airplane, it is clear why a dark circle of radius equal to the altitude appears at the center of the PPI.

The distortion is shown graphically in Fig. 5-7. The effects of introducing delays in the sweeps are also shown. Note that at a great distance S and R are approximately equal. At a distance of five times the altitude, the slant range is only 2 per cent greater than the ground range. This distortion increases rapidly at shorter ranges, being 11.5 per cent at $R = 2H$, 41 per cent at $R = H$, and 80 per cent at $R = H/2$. A checkerboard pattern made up of 1-mile squares would remain undistorted (as in Fig. 5-7*b*) if the airplane were flying at ground level. At an altitude of 1 mile, an altitude circle would appear around the center of the PPI and the checkerboard would be distorted as shown in Fig. 5-7*c*. This circle may be eliminated by delaying the start of the PPI sweep by an amount corresponding to the altitude, causing the distortion illustrated in Fig. 5-7*d*. A compromise between these two conditions appears in Fig. 5-7*e*, where the sweep delay corresponds to one-half the altitude. The exact amount of delay required to minimize the distortion due to the use of linear sweeps depends on the ratio of altitude to sweep range. In general, the distortion at the very center of the PPI is less important than the illustrations of Fig. 5-7 indicate because, in any event, any detailed information from this area is usually obscured by strong reflections from the surface of the earth.

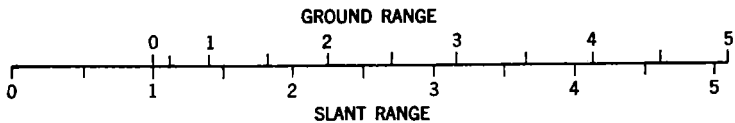

(a) Ground range—slant-range conversion chart for altitude of 1 mile.

(b) Altitude zero.
Sweep delay zero.(c) Altitude 1 mile.
Sweep delay zero.(d) Altitude 1 mile.
Sweep delay 1 mile.(e) Altitude 1 mile.
Sweep delay $\frac{1}{2}$ mile.

FIG. 5-7.—Range distortion on PPI. Each square is 1 mile on a side.

The obvious distortion at the center of the PPI in Fig. 3-8 (Sec. 3-2) is caused by the presentation of slant range rather than ground range. Note that in this figure, since the altitude of 10,000 ft is only 3 per cent of the sweep length, the altitude hole is not very large.

The PPI altitude-distortion may be practically eliminated, by the use of so-called "ground-range sweeps." These are indicator sweeps

which are not linear, like the usual slant-range sweeps, but have just the proper deflection-time characteristic to compensate for the altitude distortion. It is not difficult to see that the shape of the ground-range sweep must vary with altitude. This complication can be corrected with a marked dial which the operator sets to his altitude. Figure 5-8 shows the displacement on the PPI as a function of range or time for (a) a normal 10-mile slant-range sweep, (b) a slant-range sweep with full altitude delay, and (c) a 10-mile ground-range sweep designed for an altitude of 10,000 ft.

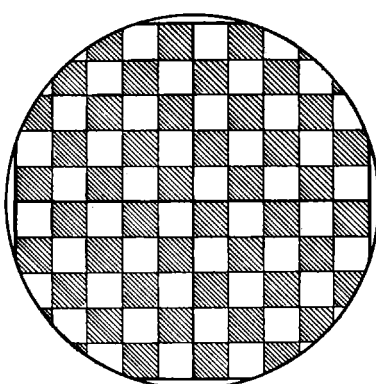
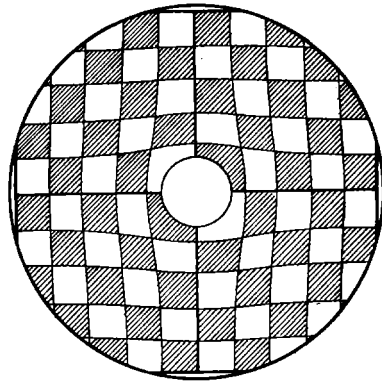
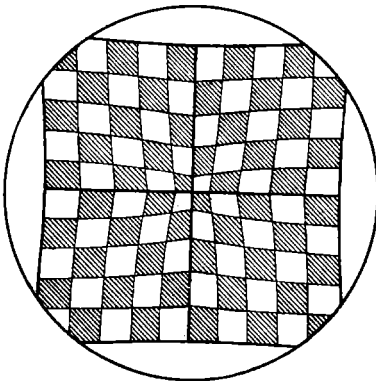
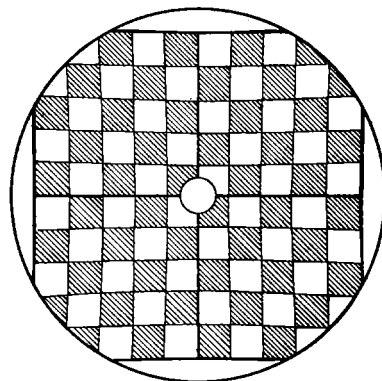
Note that in the ideal ground-range sweep of Fig. 5-8 the PPI spot must be moving infinitely fast at the start of the sweep. Because this condition is unattainable, the accuracy of ground-range sweeps is limited in actual practice. Of radar systems now in service, only the very few designed for precision use at high altitudes (25,000 ft and over) are equipped with ground-range sweeps. In systems for use at medium and low altitudes, the use of altitude-delayed sweeps as described above usually results in enough freedom from altitude distortion for all practical purposes.

Distortion Due to Finite Beam-width and Pulse Length.—The distortion resulting from the finite beamwidth and pulse length of the radar system was treated briefly in Chap. 1. As shown there, the

net result is that a point target appears on the PPI as a short arc in azimuth extending in range by an amount equal to one-half the product of the duration of the pulse and the velocity of light. This quantity, the equivalent pulse length, is the minimum separation in slant range for two resolvable point targets. A quantity of greater significance for airborne radar is the separation in *ground* range of two point targets that are barely resolved. It can be shown that this quantity is equal to the equivalent pulse length divided by the cosine of the angle of incidence between the radar beam and the surface of the earth. The cosine factor is important only at very close range.

The range resolution of a radar system is usually better than the azimuth resolution at ranges greater than a few miles. The azimuth

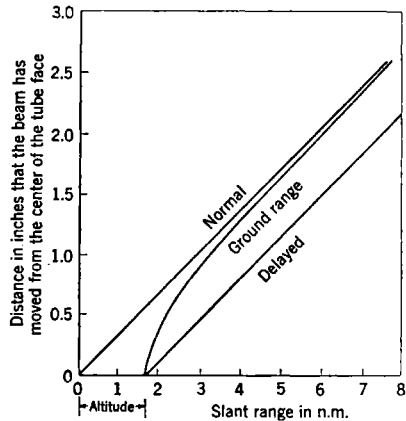

FIG. 5-8.—Sweep characteristics for an altitude of 10,000 ft. The time required for the beam to move a given distance from the center of the tube face is directly proportional to the distance along the slant-range axis.

resolution is not a sharply defined quantity. The ground range at which the two are approximately equal is given by

$$R = \frac{c\tau}{2\phi_0}$$

where c is the velocity of light, τ the pulse duration, and ϕ_0 the antenna beamwidth in radians. For such representative values as $\tau = 1 \mu\text{sec}$

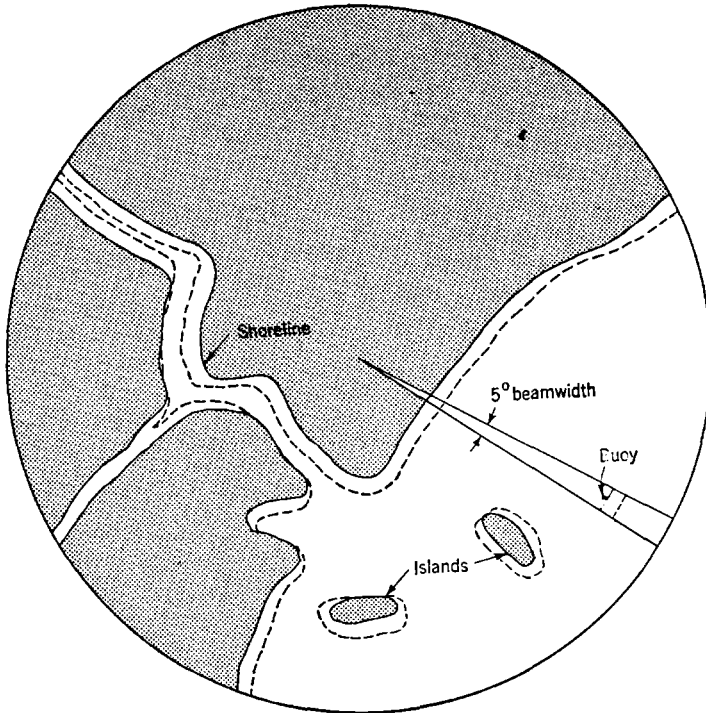

FIG. 5-9.—Apparent increase in size of land areas due to finite beamwidth and pulse length. Solid lines represent actual water boundaries, and dashed lines represent water boundary on PPI presentation. The beamwidth is assumed to be 5° .

and $\phi_0 = 3^\circ$ ($\frac{1}{20}$ radian), R is about 2 miles. Thus, for *ground* ranges beyond 2 miles, range resolution for this particular set of conditions is better than azimuth resolution, whatever the altitude.

Microwave radar systems suitable for air navigation have been built with beamwidths ranging from 0.5° to 10° and with pulse lengths of from $0.1 \mu\text{sec}$ to $5.0 \mu\text{sec}$. Many airborne radars have been built with beamwidths of about 3.0° and pulse lengths of $1.0 \mu\text{sec}$. Such sets present each point target as an arc with an angular width of 3.0° in azimuth and

extending a distance equivalent to 500 ft in range. This effect is illustrated for the PPI in Fig. 5-9 where the dotted lines indicate the apparent increase in size of land areas and the displacement of the land-water boundaries. Some PPI photographs showing this effect are presented in Sec. 3-1.

5-3. Antennas. Size, Drag, Location.—The designer of a radar system, who seeks good azimuth resolution, will choose an antenna of the largest possible horizontal aperture. He will also try to improve the range performance by choosing as large a vertical aperture as is consistent with desired ground illumination. The size of the antenna is limited by the finite size of aircraft, and by the possible reduction in aircraft performance resulting from increased drag. The number of possible locations for the antenna is restricted by the necessity for an adequate radar view of the ground. Common installations are in the bottom of the fuselage, in the nose (where the added drag can be small, if not zero), in the leading edge of a wing, and in a separate nacelle mounted pickaback above the fuselage. When the radar is to be used only on some flights, the installation may be hung beneath a wing in a removable, streamlined "bomb" which can contain all the radar components except the control panel and the indicator. Considerations of tolerable drag have indicated, for a normal military installation, a maximum antenna dimension of about 30 in. for aircraft of the 100,000-lb class and of about 18 in. for the 40,000-lb class. Commercial applications may, of course, alter these relative limits. Assuming the radars to operate at 3 cm, azimuth beam-widths are about 3° and 5° for each of the above dimensions, respectively.

Beam Shaping.—The antenna beam is especially shaped in elevation to provide uniform signal return over a wide range of depression angles. The range performance obtained with a shaped beam depends on the altitude for which the antenna is designed and on the nature of the target. For example, suppose a radar with a cosecant-squared antenna designed for 10,000 ft can, when flying at this altitude, just detect a ship target at 50 miles. Substitution of a cosecant-squared antenna with the same horizontal dimension but designed for 20,000 ft will reduce the performance so that detection at the new altitude is not possible beyond about 25 miles.

On the other hand, if a radar is able to map the ground at 50 miles from 10,000 ft with an antenna designed for that altitude, then at 20,000 ft, with an antenna designed for 20,000 ft, the ground could be mapped to 35 miles.

Types of Scanning and Scanning Rates.—In many aircraft installations a complete view of the terrain at all azimuths is not possible, or is not permissible because of drag considerations. The radar antenna then may be designed to oscillate back and forth through a fixed sector rather

than arranged to execute a complete circular scan. This is called "sector scanning." Even in radar systems with a complete 360° scan, scanning through a smaller angle, say $\pm 30^\circ$, is usually possible. This sector, subtending an angle of 60° , may be centered about any direction. Sector scanning is desirable for two reasons. First, any given ground object in the scanned area is illuminated more frequently during sector scanning than during circular scanning and maximum range performance is thereby somewhat improved. Second, sector scanning improves the continuity of reception of the radar information. For example, if a radar antenna making 12 complete revolutions per minute is installed in an aircraft with a ground speed of 400 nautical miles per hr, the aircraft moves 1100 yd between scans. If the maximum sweep speed of the radar is 1.0 nautical mile per in., signals will move across the indicator screen (assuming the aircraft to be flying at a very low altitude) in discrete jumps of 0.55 in. If, however, the radar were to scan through a 60° sector at the same angular rate, the jumps would be reduced to 0.1 in.

Improved continuity of information can also be achieved simply by scanning at a greater angular rate, although this method greatly increases the mechanical difficulties. A recent experimental system is operated at a scanning rate of 720 per min. The signals, presented on an indicator with a low-persistence screen, form a flicker-free presentation that provides the optimum in continuity of information. It seems clear that this must be the trend where fast aircraft and fast indicator speeds are concerned. For ranges beyond several miles, however, such high scanning rates are not compatible with the other parameters of the radar system or with the limitations imposed by the finite velocity of light.

5-4. Antenna Stabilization. *Need for a Vertical Scanner Axis.*—In Sec 5-2 it is explained how the PPI display may be rotated in order to compensate for changes in airplane heading and still keep north in the 12 o'clock position. Further complications result when the airplane deviates from the position it assumes in steady horizontal flight. Such deviations, caused by procedure turns, climbs or dives, or rough air conditions, make the axis of rotation of the scanner depart from the vertical.

The first radar difficulty, especially important with antenna beams that are narrow in elevation, occurs when the normal radar intensity pattern on the ground is seriously disturbed. For example, in a right bank, when the rotating antenna beam points left, it is lifted up toward the horizon (or above it), whereas when it points right it is depressed toward the vertical.

Figure 5-10 shows the type of PPI pattern that results when the aircraft departs from level flights. Note that when the antenna beam is pointed too far down, the ground clutter signals are so intense that otherwise useful close signals are obscured. Because of the persistent

qualities of the indicator screen, this bright pattern may linger for several sweeps after the aircraft has returned to straight and level flight. When the antenna beam is tilted up, on the other hand, only a few signals appear.

The second radar difficulty that accompanies departure from straight and level flight results from a distortion of the pattern which produces azimuth errors on the PPI. Such distortion is significant only when fast PPI sweeps are used at high altitudes or when accurate quantitative use is made of the radar azimuth information as in a possible type of navigational computer.

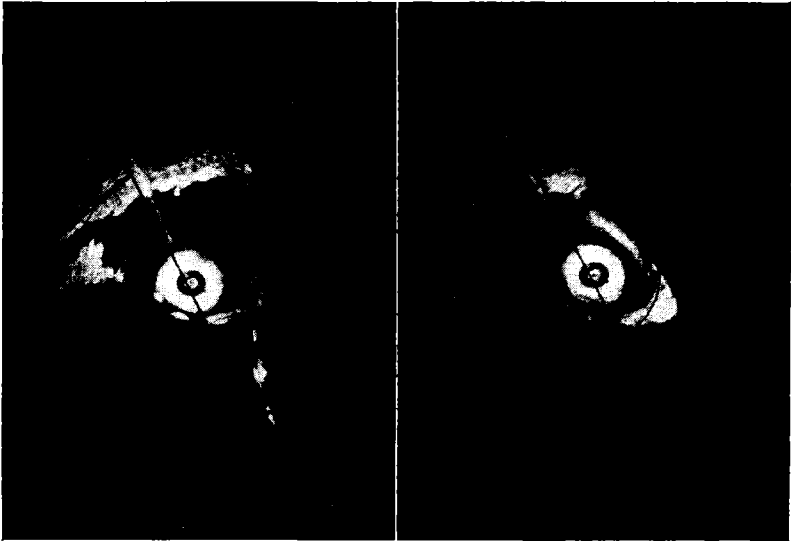

FIG. 5-10.—Effect of unequal illumination due to departure from level flight. (a) Level flight; (b) a 15° right roll. The bright line shows heading marker. The aircraft was over Nantucket Sound, Mass. Cape Cod is at the top, Nantucket Island at the lower right, and Martha's Vineyard at the left.

As an example of azimuth distortion, consider an aircraft at the instant when its rotating scanner is pointed dead ahead and its right wing has dropped from a level position through an angle a . The targets being illuminated at this instant, and hence displayed on the PPI as if they were dead-ahead, are not those on the ground line ahead of the aircraft, starting directly beneath it, but those along a line parallel to this and to the left of it by an amount $h \tan a$ where h is the altitude. In general, there will be an azimuth error during such a right roll for all targets scanned except for those along a line perpendicular to the heading and passing through the scanner. The shifts in signal position will be to the right for a right

roll, the exact azimuth error depending on both the range and azimuth of the target in question. No range errors are involved.

At an altitude of 25,000 ft, and with a ground-range sweep of 0.5 nautical mile per in., the sideways shift of fore-and-aft signals on the PPI is about 0.4 in. during a 3° roll. Such displacement might be serious under special circumstances. However, for $h = 10,000$ ft, $\alpha = 3^\circ$, and a ground-range sweep speed of 1.0 nautical mile per in. the maximum signal displacement is approximately 0.08 in., a negligible error for ordinary navigational uses.

In commercial air service, the relatively few procedure turns and other maneuvers can usually be anticipated; rough air motion is the most common reason for departures from level flight. Continuous rough air motions greatly reduce the usefulness of the radar and cause the indicator screen to resemble Fig. 5-10 much of the time. This is unfortunate since it is often precisely under these conditions that radar aid is most required.

Angular motions of the aircraft do not affect the accuracy of range measurements, provided, of course, that the radar beam continues to illuminate the target.

Stabilization Requirements.—It is possible either to reduce greatly or to eliminate both abnormal ground illumination and the pattern distortions by means of so-called “antenna-stabilization” techniques. To evaluate the need for such stabilizing devices it is necessary to know the magnitude of roll and pitch to be expected during various flight conditions and the effect of such motions on ground illumination and on pattern distortion.

The angles of roll normally encountered are, on the average, about ten times as large as pitch angles. Angular rates of roll are also considerably greater than those of pitch. Hence, the problem is primarily one of correcting for roll.

During coordinated turns, large roll angles develop. The roll angle during such a turn is given by

$$\tan \alpha = \frac{vw}{720 \times \sqrt{3}}$$

where v is the true air speed in nautical miles per hour and w the turning rate of the aircraft in degrees per second. Thus, for an aircraft doing a 3°/sec coordinated turn at a true air speed of 250 nautical miles per hr, the roll angle is 30°.

One set of measurements of average rough-air motions has been made by the National Advisory Committee for Aviation on a Lockheed transport of 55-ft wingspan. It was found that roll angles exceeded 10° during only 6 per cent of the flight time. These figures apply to average air and were compiled under conditions in which the pilot attempted to

fly a straight and level course. Clearly special operating conditions will cause wide departures from these figures.

Effects of pitch during turns and in rough air are usually small. Leveling difficulties may occur, however, under special circumstances. In every aircraft there is a pair of level pads, small machined bosses so placed that the line joining them is horizontal during level flight at rated indicated air speed and for normal aircraft load. The radar scanner is installed so that its rotational axis is perpendicular to the line determined by the level pads. Departures of the level-pad line from the horizontal, caused by climbs or dives, operation at other than standard indicated air speed, and operation with other than standard loading, produces distortion of both the illumination and the apparent azimuth on the radar. A range of adjustment of 10° in the direction of the scanner axis can compensate for most of these departures from horizontal.

The variations in pitch described above can be easily compensated for by means of a screw so arranged that it can tilt the scanner base through $\pm 5^\circ$ about an axis parallel to the wingspan line axis. This screw may be operated manually with a flexible shaft either at the scanner or by remote control. The adjustment is made in flight, the criterion being that the ground clutter signals in the forward and rear sectors on the PPI appear equally bright. Automatic operation with a pendulum-controlled motor is also possible. Even though many aircraft now in service do not have leveling screws, they are a useful feature.

Methods of Stabilization.—The ideal solution to the problem of non-level flight would be to support the rotating antenna system in a double set of gimbals, driven in such a fashion that the scanner rotational axis always remained vertical. This stable-base stabilization is relatively costly in weight and is probably not justified for general commercial application. There are less costly approximate corrective devices which perform quite adequately. Two of these, line-of-sight stabilization and roll stabilization, are discussed below.

A need common to all stabilization schemes is a device for detecting departures of the aircraft from level flight. A gimbal-supported gyroscope provided with some self-erecting mechanism is nearly always used for this purpose. It has the drawback that the erecting mechanism, which is purposely gravity-sensitive and acts so as to align the gyrospin axis with the vertical during level flight, also responds to centripetal forces. During a protracted turn it will tend to pull the gyroaxis away from the vertical and align it parallel to the resultant of gravity and the centripetal acceleration. This effect, which is serious only in long turns, may be eliminated in some cases by disabling the erecting mechanism during these turns.

The most common method of stabilization is called line-of-sight

stabilization. Here the scanner base is fastened rigidly to the aircraft, and the beam is held pointed in the right direction by tilting the antenna as the scanner rotates. Thus if the right wing drops (right roll), the antenna must tilt upwards from its normal level flight position when pointing to the right and downward when pointing left to maintain normal ground illumination. When pointing fore or aft no tilt correction is required. Thus one complete cycle of tilting per revolution must be accomplished. For rapid-scanning or sector-scanning systems this can prove costly in terms of weight and power.

Ground illumination maintained by line-of-sight stabilization is adequate only for roll or for pitch. For combined roll and pitch, the illumination pattern departs somewhat from the normal. Because the scanner rotational axis actually leaves the vertical during maneuvers, PPI azimuth distortions occur to the same extent as if no stabilization were used at all. These distortions can be partially compensated for by displacing the PPI pattern with the aid of electrical information from the gyro. The weight of present line-of-sight stabilizing equipment is about 50 lb. for a 350-lb radar system.

Roll Stabilization.—A second method, which has been used only in experimental installations, is roll stabilization. While it weighs more and requires more space in the radome (for 360° coverage at least) this scheme corrects perfectly when roll alone occurs. There is no provision for correction of pitch but, as has been pointed out, pitch effects can usually be neglected.

Roll stabilization, in its simplest form, is accomplished by suspending the scanner on trunnions so that it can be made to rotate about an axis parallel to that of the aircraft level-pad. When the aircraft is rolling, this rotatable scanner assembly is driven by a motor, deriving its excitation signal from the gyro. The motor has to operate only slowly and infrequently in comparison with the tilt motor of line-of-sight stabilization.

Stabilization of antennas is a fairly recent development in airborne radar. The choice between roll stabilization and line-of-sight stabilization is difficult. In general, the cost of somewhat greater weight and radome size required by roll stabilization will be worth while only when correction of the azimuth distortion is important. Antennas of many of the radar systems now in service are not stabilized at all. Of those that are, nearly all are stabilized in line-of-sight. Unstabilized radars include systems developed before the advent of stabilization and more recent systems of small antenna diameter (broad antenna beam) designed for service at medium and low altitudes. A complete discussion of antenna stabilization will be found in *Radar Scanners and Radomes*, Vol. 26, Radiation Laboratory Series.

CHAPTER 6

ENGINEERING AND ECONOMIC CONSIDERATIONS

BY W. M. CADY, F. R. BANKS, JR., R. L. SINSHEIMER, D. HALLIDAY,
AND H. FAHNESTOCK, JR.

6-1. Installation.¹ *Scanner Installation and Radome Problems.*—The installation of the scanner presents a difficult problem. Some compromise which gives a good vantage point for viewing the ground, minimizes the drag coefficient of the airplane, and at the same time makes the scanner easily accessible must be found.

The only position from which the scanner has a good 360° view is beneath the fuselage. But in this location, too great a protrusion below the keel line adds to the aerodynamic drag. On the other hand, if the antenna is retracted too far, coverage is inadequate because the field of radiation is partially blocked. The minimum protrusion allowable from the radar point of view in the prototype of each installation must be determined by measurements of the antenna pattern made with the antenna installed in a mockup. Such measurements have shown that certain recent scanning fanbeam antennas give satisfactory results if they are installed so that nearly half their height is above the keel line of the airplane. These experimental results have been confirmed by observations of the indicator in flight. Even in a belly installation, however, parts of the aircraft may cast shadows. Figure 6-1 shows the blanking of a part of the landscape caused by the partially retracted landing wheels of a C-47 in which the equipment was installed. Similar blocking due to the close approach of another aircraft is shown in Fig. 6-2.

The airborne scanner must be housed for protection against wind and weather. Its shelter is called the radome, and must be considered a part of the radar. The radome presents difficult problems of aerodynamics, transmission of electromagnetic waves, and structural design.

The aerodynamic problem arises because the antenna must protrude from the airplane; this requirement is probably most embarrassing in the case of belly installations. Antennas now in use must protrude somewhat more than half their height (12 to 36 in.) and the radome must protrude enough to allow about an inch clearance as the antenna scans. Early radomes were cylindrical and not streamlined at all. They reduced the

¹ By W. M. Cady.

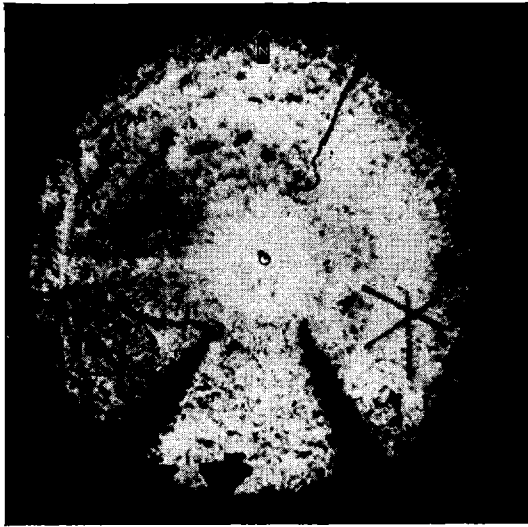

FIG. 6-1.—The aircraft wheels block the radar beam and produce two wedge-shaped shadows on the PPI.



FIG. 6-2.—A shadow on the PPI caused by a large airplane that blocks the radar beam. This airplane is flying just below and slightly behind the one in which the photograph was taken. The radar signal from the airplane is lost in the bright spot at the center of this picture.

speed of the airplane as much as 13 mph. Later, streamlined radomes, which reduced speed as little as 2 mph, were installed in some large airplanes. If coverage to the rear is not required, the scanner can be located well forward where the keel line of the fuselage slopes upward to the nose. In such a location the radome becomes part of the skin, thus offering no increased drag whatsoever. This is the desired ultimate in radome installations.

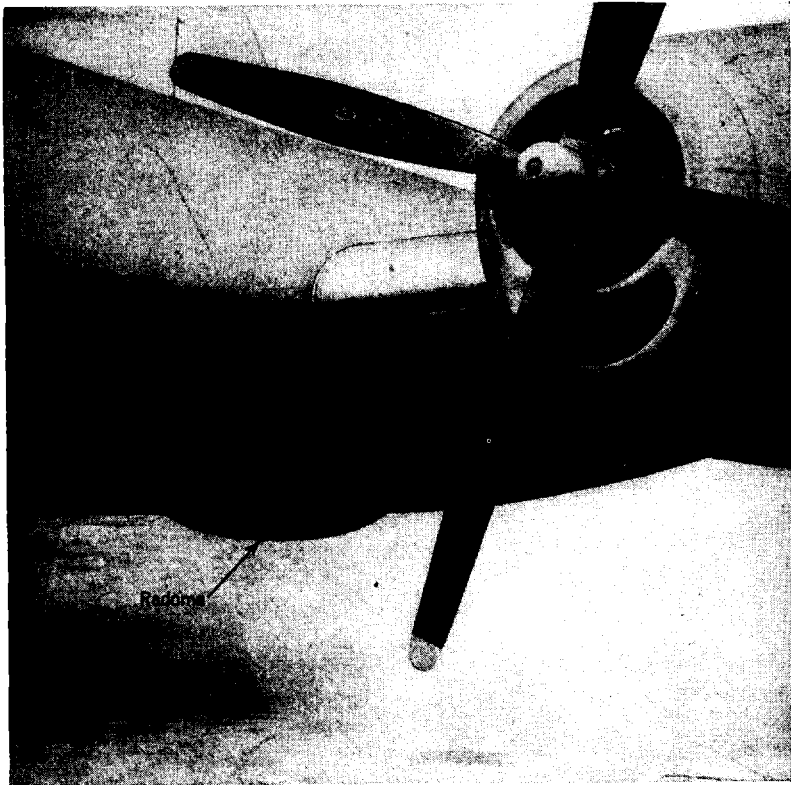

FIG. 6-3.—This recent belly installation of a 60-in. radar antenna on a large airplane proved satisfactory.

Figures 6-3 and 6-4 are examples of aerodynamically good and bad installations, respectively. These installations are for identical functions. The installation in Fig. 6-4 was not carefully planned, whereas Fig. 6-3 shows a good example of the results of cooperation between the radome designer, the antenna designer, and the aircraft manufacturer who also engineered and constructed the antenna. Similar cooperation in the case of another installation, shown in Fig. 6-5, has resulted in a satis-

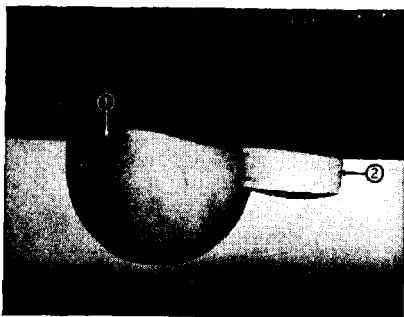

FIG. 6-4.—This early antenna installation on a large airplane is aerodynamically poor. A retractable radome (1) is partly extended below the fuselage, and the transmitter unit (2) is aft of the radome.



FIG. 6-5.—The design of a radome to house an 8- by 3-ft parabolic reflector underneath the airplane presented a difficult problem in streamlining. Two additional vertical stabilizers were required.

factory solution of an extremely difficult problem involving an 8-ft antenna. It required the addition of two outboard vertical stabilizers to the empennage.

In radome design transmission of the radiant energy is a consideration even more important than streamlining. Indeed, if the streamlining is carried too far, the energy from the antenna may fall upon the radome at angles so oblique that a great part of it will be reflected instead of transmitted. At present, the best radome design for the 3-cm band transmits efficiently only if the angle of incidence never exceeds 70° . After an aerodynamically reasonable shape has been decided upon, it is therefore necessary to check the angles of incidence of the radiation with the aid of a ray diagram.

The thickness and construction of the wall of the radome can be determined on the basis of structural considerations within the limits determined by the allowable reflection. The reflection is a function of the dielectric constants, thickness of the material, and angles of incidence of the radiation. The fundamental electrical equations and engineering considerations are given in *Radar Scanners and Radomes*, Vol. 26, Chaps. 9 to 14, of this series. The combined one-way reflection and transmission losses do not usually exceed 10 per cent. Actual structural and electrical tests are necessary to assure a satisfactory design, for in a streamlined shape the calculations can at best be only approximate.

Installation of Other Units.—The other units of the radar are easier to install than the scanner and the radome. The designers of the aircraft and of the radar must collaborate in order to assure optimum performance. For operational comfort, the indicator should be at a convenient height and angle, and the most frequently used controls should be close at hand. The ambient light and glare in the operator's compartment should be kept very low. For the remaining electronic components, the installation requirements are rather less stringent.

6-2. General Design Considerations.¹ *Temperature, Pressure, and Humidity.*—The ambient operating conditions—temperature, pressure, and humidity—for an airborne radar are often extreme. The same set that must be ready for immediate use after standing in the desert sun must also perform at stratospheric temperatures. The required ambient temperature range has been set by the Army and the Navy at -67°F to $+160^\circ\text{F}$, even though the equipment is not often subjected to these rigorous extremes, particularly in peacetime. In some components, however, particularly in sealed electronic units, the internal temperature rise is sometimes considerably above this temperature range.

Operation at high humidity is a requirement to which, for several reasons, increasing attention must be given. First, after use at low

¹ By W. M. Cady.

temperature (for example, in the stratosphere), a rapid descent to a region of high absolute humidity causes the formation of much frost and dew on mechanical and electrical parts. These formations may cause short circuits, corrosion, and energy loss in the transmission lines. Second, the diurnal temperature changes in the tropics cause "sweating" and consequent deterioration of electrical parts. And third, humid conditions favor the growth of fungus, even on circuit components. The defense against humidity is to seal the transmission lines hermetically and to seal or "fungus-proof" the electrical components.

Equipment to be used in the tropics should be treated with any of several commercially available fungicidal paints and sprays. When the equipment is not in operation, it should be kept at a temperature above that of the surroundings to reduce the humidity and inhibit fungus growth. The temperature may be maintained at an appropriate level by leaving the heaters of vacuum tubes turned on.

The range of pressure in which a radar must operate extends from atmospheric to about one-sixth of an atmosphere. The most notable effect of lowered pressure is arcing, which may occur in the transmission line, particularly at connectors and rotary joints, or in the modulator or other circuits where high voltages exist. Arcing is prevented by careful design of the transmission line, adequate spacing of circuit elements, and particularly by hermetic sealing. The transmission line, whether it is waveguide or coaxial conductor, can be hermetically sealed even at the rotary joints; similarly, the high-voltage circuits can be packaged in an airtight container. It is rather common practice to maintain the pressure in some parts by a small airpump because truly hermetic sealing is often difficult and impractical. Sometimes almost the entire radar is sealed in an airtight "bomb."

An airborne radar is subject to certain mechanical hazards, of which vibration is one of the more serious. Most of the chassis that house the electronic components are vibration-isolated, but the scanner is usually rigidly attached to the airframe. The shock of a rough landing can cause damage to the radar. Vibration isolators and shock mountings are probably not effective in softening a hard landing, however, because their total motion could not much exceed $\frac{1}{4}$ in.—an insignificant addition to the protection already afforded by the shock-absorbing mechanism of the landing-gear. As for the scanner and the cabling, inexpert handling is probably even more destructive than vibration and shock, and extra ruggedness must be planned for these components.

Reduction of Weight.—Weight¹ is an extremely important consideration for airborne radar, as for any other flying equipment. Although the

¹ W. L. Myers, "Weight Analysis of Airborne Radar Sets," RL Report No. 450, Jan. 1, 1945.

urgency of war often prevented the most careful attention to the problem of weight reduction, one military system, AN/APS-10, was engineered with ounces in mind. Table 6-3 lists the approximate weight of each component of this navigational radar, including its mounting.

The general trend of weight reduction for airborne radars is concentrated along several channels. Perhaps the greatest reductions in weight have been effected by the replacement of heavy components with radically new and much lighter ones, like miniature tubes and the hydrogen-thyratron modulator. Miniature tubes are, in themselves, not much lighter than standard ones, but their use permits the design of very much

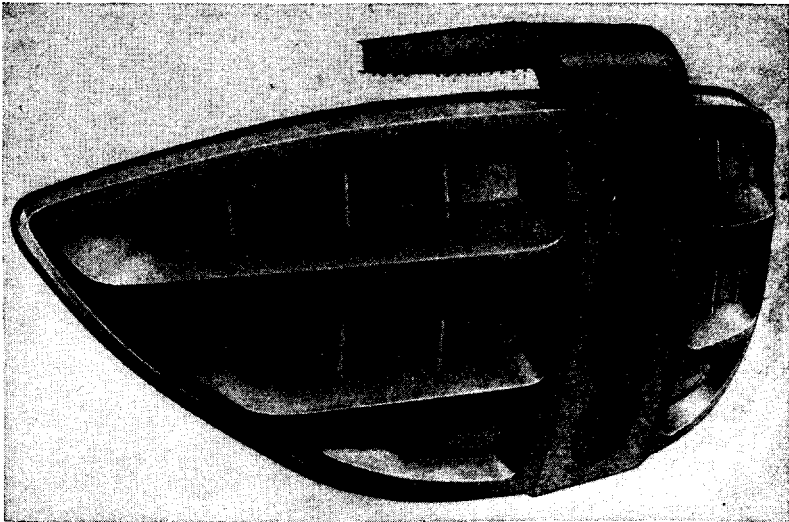

FIG. 6-6.—Rear view of an 8-ft. parabolic reflector constructed for airborne use according to aircraft design methods. The radome shown in Fig. 6-5 was designed to house this unit.

smaller and lighter chassis. In some cases, also, the power required is substantially reduced. Aluminum and magnesium find increasing application in chassis for the electronic units, in the transmission line, and in the scanner. Nickel has been successfully used as the material for light-weight electroformed transmission lines; metalized plastics may possibly be put into use for this purpose. The methods of aircraft structural engineering have proven adaptable, especially for the larger antennas. Such methods have been used in the construction of the 8-ft reflector of a recent system designed for the 10-cm band and the 60-in. antenna of a set operating at about 3 cm. These are illustrated in Figs. 6-6, 6-7, and 6-3.

Roughly 10 per cent of the weight of an installed airborne radar set

is in the transformers. It is obvious that transformers of lighter weight are very desirable.¹ Improved core materials have been developed, and transformers may now be impregnated with a polymerizing varnish instead of being "potted" in a can of oil.

The manner of packaging the radar and the construction of the interconnecting cables is important in saving weight. The use of a few large packages is more economical than the use of many small ones, because large packages require fewer chassis and cables. The cables, representing about 10 per cent of the weight of the installed radar, are now often

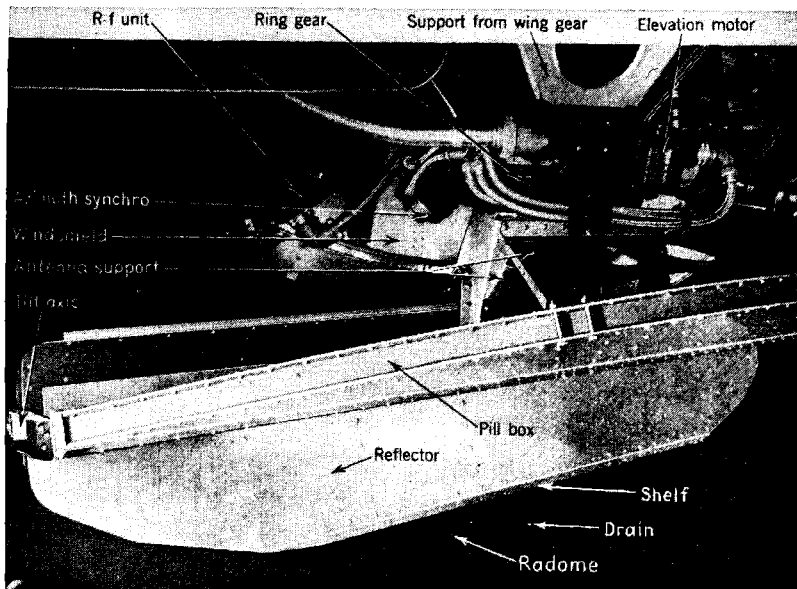

FIG. 6-7.—This 5-ft antenna may be installed partly within the fuselage.

sheathed in a flexible plastic tube rather than in a heavy metal conduit, thus both saving weight and improving water resistance. Certain of the conductors in such cables, however, may require individual electric shielding. In designing the installation it must be remembered that the transmitter frequency will be unstable if the magnetron is too far from the antenna; practical limits are from 25 ft for 10-cm coaxial line to 6 ft for 1-cm waveguide. This limitation is discussed at greater length in *Microwave Magnetrons*, Vol. 6 of Radiation Laboratory Series.

A reduction in the weight of a radar might be attained by altering the

¹ Recent advances in the engineering of transformers and other electrical components are discussed in *Components Handbook*, Vol. 17, Chap. 1, Radiation Laboratory Series.

frequency and voltage of the power sources now available. It is questionable, however, whether frequencies higher than the nominal 400 cps now in use would be very effective because the saving in transformer iron might be offset by an increased weight of equipment for controlling the voltage and the waveform. Voltages higher than the nominal 24 volts d-c now used would allow reduction of the weight of the copper in the cables.

Although the weight of existing radar sets ranges from 50 to as high as 500 lb, in redesign for peacetime use newer manufacturing practices will probably make possible a material reduction.

Primary Electrical Power.—The power for operating an airborne radar comes from generators mechanically driven by the aircraft engines. The requirements are for a small amount of d-c power at 27 volts and a preponderance of a-c at 115 volts and 400 to 800 cps. For microwave radar, the a-c load is usually in the range 1 to 3 kw. Some simple radar devices, such as altimeters and the like, require less than 100 watts.

Although the d-c generators now in use are fairly satisfactory, the rigid insistence on light weight has prevented realization of both reliability and satisfactory output characteristics in the a-c generators. At present, heavy generators must be tolerated if the requirements of constant waveform and voltage (sometimes as strict as ± 3 per cent) are to be met despite reasonable variations in frequency (400 to 800 cps) and in load characteristics. Although a sinusoidal waveform is not essential for its own sake, generators which provide an extremely impure output are also likely to produce an undesirable change in the waveform with changes in load. In most installations the a-c power is still supplied by an inverter, but single-engine Navy airplanes have engine-driven generators for both alternating current and direct current.

Electrical Noise Interference and Its Elimination.—The radar may cause noise in the radio and intercommunication systems. Correct design and installation of both these and the radar system can greatly mitigate this disturbance.¹ Any wire that is not within a shielded enclosure and carries high frequency or sharply varying current is a possible source of noise. Pickup may be prevented by: shielding or filtering the leads of the communication systems; designing the radar to avoid, as far as possible, pulsed or high-frequency currents in long leads, and shielding the leads which must carry such currents; filtering at the noise source within an offending unit; and providing adequate grounding of all shields and chassis to the airframe. Any spare wires in cables should be grounded.

D-c motors are notorious sources of noise. At present, the usual cure

¹ Air Technical Service Command Technical Note TN-TSERR2-1, "Notes on Design of Radar Systems Which do not Cause Radio Interference."

for an offending motor is to filter its leads and enclose it in a grounded cage. Because brushless a-c motors are not noise sources, they would be preferable, although at present they are not in wide use.

The noise normally observed on the indicator of any radar should be merely that unavoidable noise due to statistical fluctuations in the input circuit and in the first tubes of the receiver. Other noise, which must be ascribed to external causes, is sometimes visible, however. Interference from other radar sets is occasionally bothersome; if it originates in the same airplane it can be suppressed by blanking the receiver of each radar at the instant that the other one is transmitting a pulse. In general, however, it can be said that airborne radar is much less vulnerable to noise than is the radio.

*Test Equipment.*¹—The reason for maintenance of airborne radar systems, as of radio transmitting and receiving stations, is to attain and maintain peak performance. Only the general nature and extent of radar maintenance is discussed here.²

The two major factors on which the performance of a radar system depend are, in order of importance: the sensitivity of the receiver, or its ability to detect very weak signals; and the pulse power output of the transmitter. Test equipment used has to be capable of measuring accurately both of these quantities.

It has been found desirable to divide the maintenance of aircraft radar systems into three major categories: tests made in flight; tests made at the aircraft on the ground; and tests made on the bench (after equipment has been removed from the aircraft). The other aspects of the maintenance program, such as the test equipment to be used, the measurements to be made, and the scope of the maintenance personnel training follow these three divisions.

Tests are made in flight simply to provide the radar operator with a means of deciding what reliance should be placed on the radar equipment, or to locate and repair very simple equipment failures. Only a very limited number of measurements³ can be made; the test equipment for these measurements has to be simple, and the instruction literature and the training required for using the equipment should not be extensive.

¹ By F. R. Banks, Jr.

² See *Radar System Engineering*, Vol. 1, Chap. 17, Radiation Laboratory Series.

³ A permanently installed "echo box," which can be tuned by a control near the radar operator or provided with automatic tuning, has been used as test equipment in flight. Carefully calibrated echo boxes can be very useful for measuring over-all radar performance (a combination of pulse-power output and receiver sensitivity). An echo box, however, is not suitable for checking the sensitivity of the beacon receiver of the aircraft. Alternatively, a separate power meter and r-f noise generator might be used. The equipment used in flight should, in general, be no more complicated than either of these devices; and the total weight should not exceed 10 to 15 lb. Of course, a simple test meter to check voltages, fuses, and continuity of leads, is essential.

This airborne test equipment must be lightweight and compact, and the cost of carrying it must be balanced against the increased usefulness of the radar.

Tests made at the aircraft on the ground are designed to provide a quick, reliable check of the radar system, and to isolate and replace a faulty major assembly such as a receiver-transmitter unit, an indicator unit, or a synchronizer unit. Because these tests can be made by the same personnel who check the radio equipment and inspect the motors of the aircraft, the training for both radar and radio maintenance can be conducted concurrently. The test equipment can be somewhat heavier and more versatile than that carried in the aircraft but must be portable and not too complicated for speedy use. The instruction literature and the training program become correspondingly more extensive. The speed and efficiency with which measurements are conducted depend on a thorough familiarity with the equipment and on the kind of measurements to be made.

Tests made on the bench are the most extensive in the maintenance program. They have three objectives: first, to ascertain what sub-assembly or functional unit is causing the reduced performance of a particular major assembly; second, to replace or repair that subassembly or functional unit; and third, to have a ready supply of major assemblies available for immediate call. Because these measurements are comprehensive, an extensive line of test equipment must be available. It may be an integral part of a permanent maintenance installation since portability is not an important consideration. The instruction literature and the training program have to be very complete; thoroughness is more essential than speed. Experience has shown that personnel trained in "trouble shooting" in radio circuits become most adept in this kind of maintenance.

If a maintenance program such as that outlined above is to be followed, corresponding requirements are placed upon the design of the radar system. The system as a whole must be comprised of individual major assemblies which can be isolated readily one from another in the event that one is faulty; and the major assemblies must be comprised of subassemblies or functional units.

An estimate of the cost of training maintenance personnel, of the installation and maintenance of equipment, and of operating an airborne radar system is given in Sec. 6-7.

6-3. Performance of AN/APS-10.¹—The preceding sections in this part of the book have described the functional and engineering principles involved in the design of an airborne radar system. The application and integration of these principles may best be illustrated by an analysis of

¹ Sections 6-3 to 6-5 by R. L. Sinsheimer.

the design of a simple airborne system, AN/APS-10, manufactured by the General Electric Company.

This radar is designed to serve as a general-purpose navigational aid, to provide adequate radar mapping and storm warning for most navigational purposes, and is equipped to interrogate and receive radar beacons.

Because this system was designed for use in many and varied aircraft, such qualities as reliability, ease of maintenance, light weight, low power

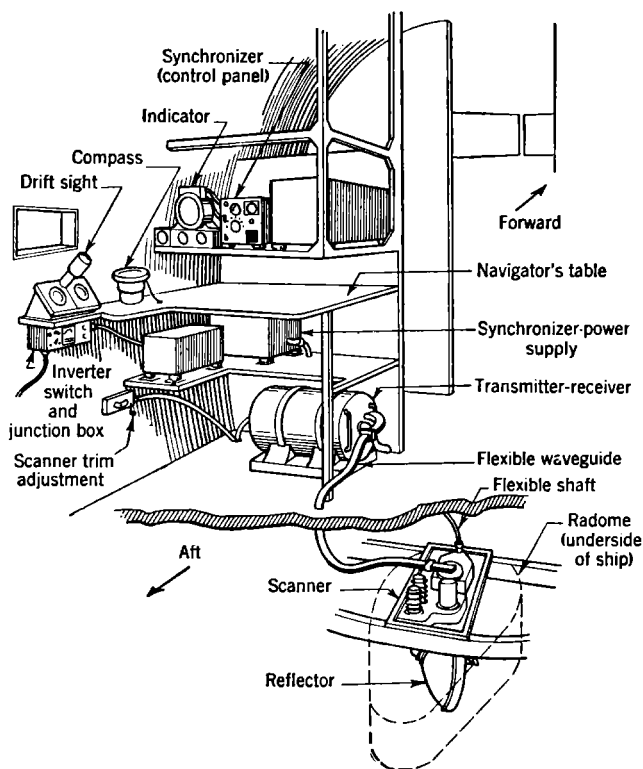

FIG. 6-8.—A typical arrangement of an AN/APS-10 system installed in an airplane.

consumption, simplicity of operation, and flexibility of installation have been stressed rather than extreme range performance or highest resolving power. A typical installation of this equipment is shown in Fig. 6-8. Figures 6-9 and 6-10 show that its resolution is adequate to define coastlines clearly, to outline lakes, to reveal moderately broad rivers, and to distinguish cities, mountains, ridges, and gaps. Figure 6-11 shows beacon replies.

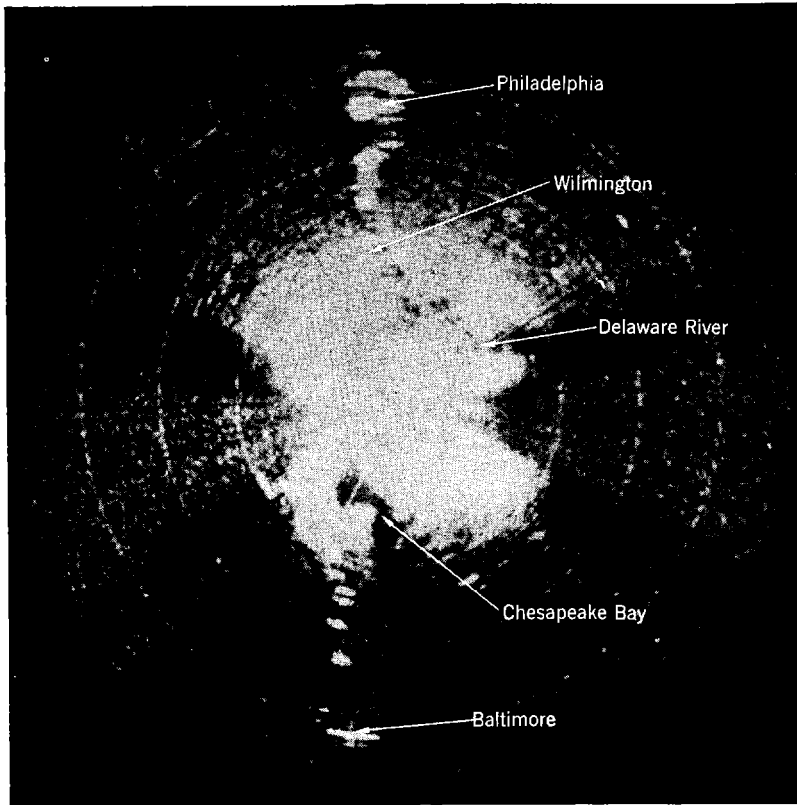

FIG. 6-9.—AN/APS-10 presentation of the Chesapeake Bay area, Maryland, from 5600 ft. The engine nacelles mask signals at azimuths of 100° and 260°. Pulse length 0.8 μ sec. range circles 10 nautical miles apart.

TABLE 6-1.—RANGE PERFORMANCE OF AN/APS-10

Target	Range in nautical miles
5000-ton ship.....	25
Land "painting".....	25-30
Storm clouds.....	10-40
Mountains.....	25-35
Cities.....	20-50
Beacons	
AN/CPN-6.....	150 if not limited by horizon
Permanent ground installation	
AN/UPN-3.....	At least 115 if not limited by horizon
Semi-portable	
AN/UPN-4.....	40-70
Portable	

Typical maximum ranges achieved by AN/APS-10 with radar targets and beacons are shown in Table 6-1.

6-4. Characteristics of the AN/APS-10 Radar: I. Choice of Functional Parameters.—The small space available for antennas in aircraft was the principal limiting factor in determining the functional parameters

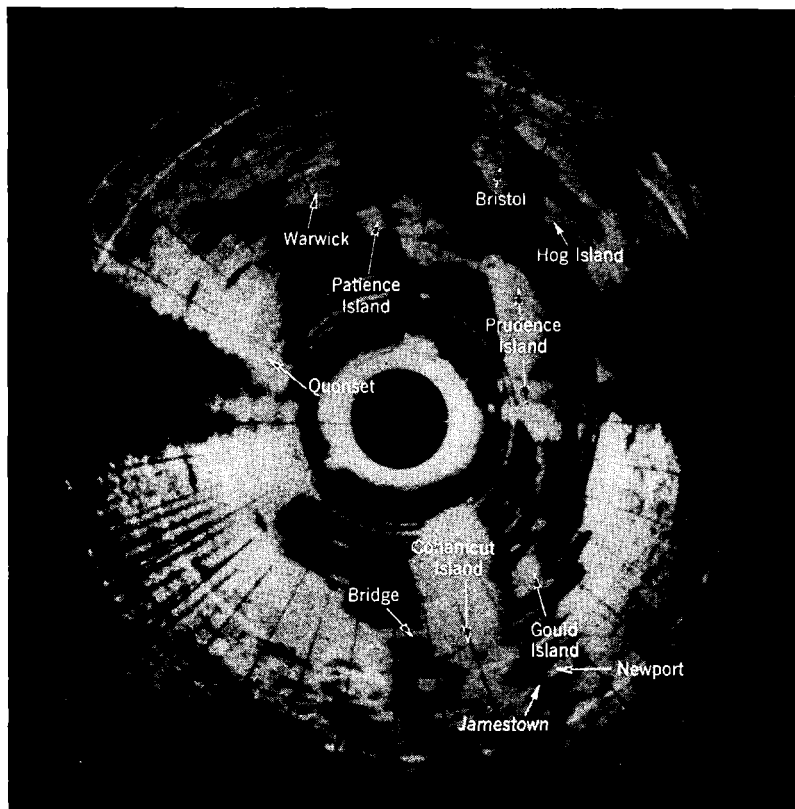

FIG. 6-10.—Presentation showing Narragansett Bay, R.I., from 1000 ft. Taken with an AN/APS-10 using a special antenna with a beamwidth of 3° instead of the usual 5° . Pulse length $0.8 \mu\text{sec}$, range circles 2 nautical miles apart.

of the AN/APS-10 set. Scanning of the entire 360° of azimuth was considered essential for the radar to accomplish its purpose as a navigational aid. This required that the antenna be below the airplane to secure unobstructed vision.

The use of a small antenna necessitated the use of a short wavelength to obtain the narrow beam necessary for adequate radar mapping. It was impractical to use 10 cm for this reason and 1.25-cm apparatus was

in a relatively new and undeveloped state at the time of the design of AN/APS-10. Furthermore, at 1.25 cm the range is cut down by the absorption by water vapor. The remaining available microwave band at 3 cm was selected.

The 5° beamwidth obtained at 3 cm with an 18-in. paraboloid gave

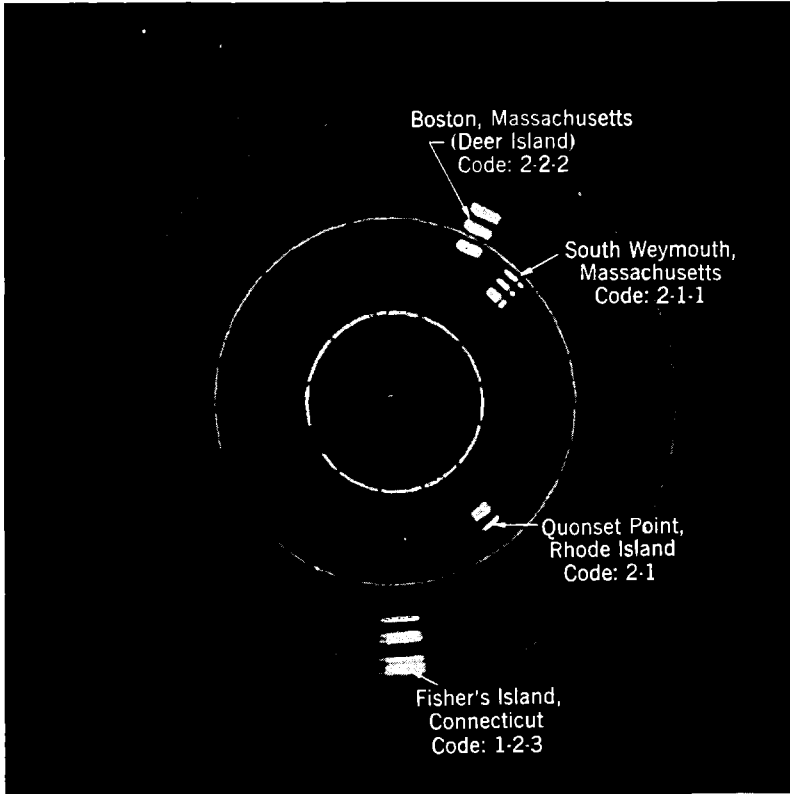

FIG. 6-11.—Signals from four different beacons on the indicator of AN/APS-10 from an aircraft about 5 miles west of Woonsocket, R.I. Range circles 20 nautical miles apart, altitude 3200 ft. Note the coded response.

adequate azimuth resolving power for general navigation. An 0.8- μ sec pulse length with wide-band i-f and video amplifiers provided the necessary resolution in range.

For uniform mapping, a cosecant-squared antenna pattern in the vertical plane is desirable even though such a pattern can be optimum for only one altitude. Also, the higher the altitude for which the pattern is designed the lower the antenna gain. A cosecant-squared pattern

suitable for an altitude of 7000 ft was chosen as a compromise. Such a pattern (see Figs. 6-12 and 6-13) is useful at ordinary altitudes (from 1000 to 10,000 ft) without too strongly over-illuminating the foreground

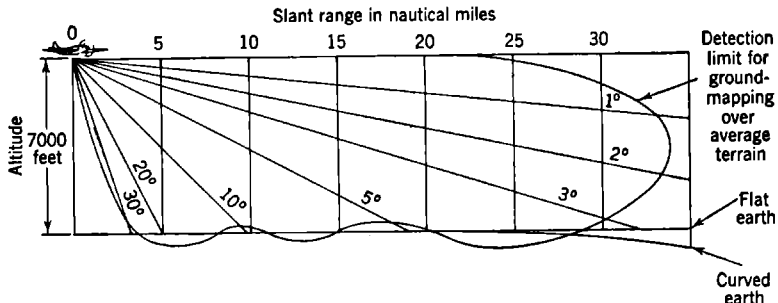

FIG. 6-12.—Coverage diagram of AN/APS-10 showing the range at which average terrain can be detected at different angles of depression. The range of detection on rough terrain is greater, and on smooth terrain less, than is indicated in this diagram.

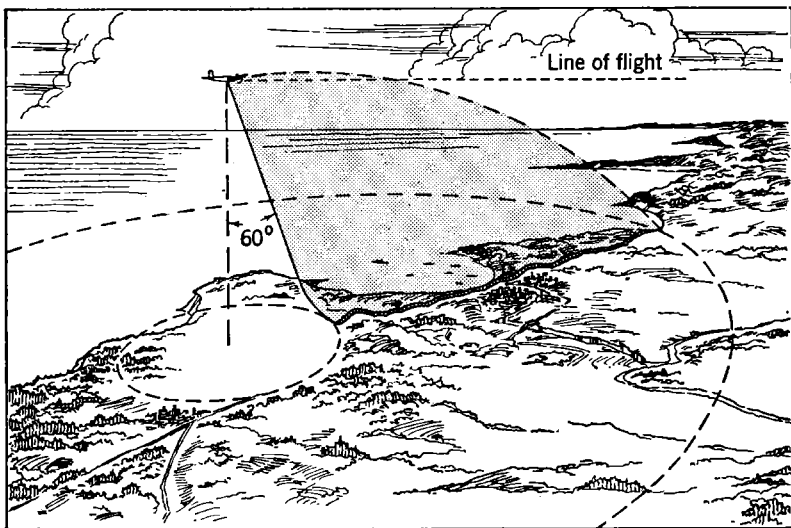

FIG. 6-13.—Coverage diagram of AN/APS-10. A three-dimensional view of the coverage shown in cross section in Fig. 6.12.

at low altitude or under-illuminating it at high altitude. This antenna has a gain of 700.

The pulse-power output needed to achieve adequate range performance was determined from this antenna gain and from figures for the best receiver sensitivity available, and by comparison with the range perform-

ance and parameters of existing systems. The calculations revealed that a pulse-power output of 8 to 10 kw was necessary. This permitted the use of a lightweight low-voltage transmitter—the 2J42 magnetron—and resulted in appreciable reduction in the weight, power consumption, and complexity of the modulator and modulator power supply as compared with previous similar equipments.

Because of this low-power output and the small antenna, a stable receiver of high sensitivity was required. As in most radar systems, a superheterodyne receiver is employed. Reliability is improved by the use of an AFC system for the local oscillator with a separate mixer for the AFC channel.

The choice of other parameters, such as pulse-repetition frequency, PRF, and scan rate, depended on the requirements of coverage and range performance. The PRF on search operation was limited by the time necessary for each pulse to go to the maximum useful range and return, in addition to the time required for the indicator circuits to recover between successive sweeps. This consideration led to a PRF of 810 per sec. For beacon operation this value is halved so that the 2.2- μ sec pulse length necessary for beacon interrogation will not too drastically increase the power requirements of the modulator above that of search operation.

This lower repetition frequency on beacon operation sets an upper limit to the scan rate since several pulses, at least, must trigger the beacon each time the beam sweeps by. In an aircraft traveling 4 to 6 miles per min, only a few seconds can be allowed between successive scans in order that the range of nearby targets should not change too rapidly (see Sec. 5-3). As a compromise, a scan rate of 30 rpm was adopted. This provides a look at each target every 2 sec and even at the lower repetition rate five or six effective pulses per scan strike the beacon.¹

To provide reliable long-range beacon operation, every effort has been made to achieve a high receiver sensitivity for beacon signals. Automatic frequency control with a reference cavity is used to hold the local oscillator of the beacon to the proper frequency for the beacon reception. Video pulse stretching of the beacon signals (see *Radar Beacons*, Vol. 3, Sec. 2-3) is incorporated to enhance the brilliance of the beacon return on long-range sweeps.

Presentation.—The PPI presentation, best for a navigational radar system, is employed in AN/APS-10. The M-S type is used because it is lighter and gives more accurate azimuth data transmission than the M-E type, and does not require the precise mechanical construction needed

¹ Only half the pulses incident upon the beacon are effective because the frequency range to which the beacon (AN/CPN-6) is sensitive is rapidly switched between two bands. This is done in order to cover the wide range of frequencies used for 3-cm airborne radar.

for the M-M type. (See Sec. 1-8 for a discussion of these three methods of deflecting the beam.)

The choice of range sweeps closely follows the operational capabilities of the system. An adjustable sweep, continuously variable from 4 to 25 miles, is provided for the operator's convenience in following the target. A 50-mile sweep allows the detection of cities beyond the general area of land mapping. Extra 0- to 90- and 70- to 160-mile beacon sweeps are provided to take advantage of the ability of the system to pick up distant beacons. The range marks provided are those most convenient to the operator. The specifications for the sweep lengths and range marks are shown in Table 6-2.

TABLE 6-2.—SWEEP LENGTHS AND RANGE MARKS USED IN AN/APS-10

Sweep ranges in miles	Range marks
0-4 to 0-14 (continuously variable).....	every 2 miles
0-15 to 0-25 (continuously variable) } and 0-50	every 10 miles
0-90 and 70-160.....	every 20 miles

A tube face with a diameter of 5 in. was the smallest that could be used to provide a picture easily interpreted by the operator. The restricted space in aircraft prohibited the use of a larger tube. The persistence of the cathode-ray tube was chosen to match the scan rate by providing a map that neither faded between scans nor blurred after the second scan. For the avoidance of blurring a P-14 was found to be preferable to a P-7 phosphor.

To combat unfavorable ambient light conditions, cathode-ray tubes giving high light intensity are employed, but for many installations—and especially for any cockpit installation for a pilot—a visor is necessary for observing the tube.

There is usually an indicator at the navigator's position in an aircraft. For some installations, however, it is desirable that the pilot also have an indicator. For this purpose full provisions for a second, remote indicator are included.

Operation.—Considerable effort was expended to simplify the operating controls of AN/APS-10 and to make them virtually foolproof.

There are four frequently used and four infrequently used operating controls, and two more that are primarily for the operator's convenience. The four commonly used controls are:

1. A *Range Selector Switch* to select the scale of the radar map displayed on the PPI.
2. A *Receiver Gain Control* to obtain information about the relative strength of the radar targets and to bring out terrain detail otherwise hidden.

3. A *Tilt Control* and *Tilt Meter* to permit adjustment of the depression angle of the antenna beam to the optimum value for any given altitude. The tilt meter is calibrated in terms of altitude in thousands of feet to serve as an appropriate guide to the proper antenna depression for maximum coverage at any given altitude. The beam can be tilted from horizontal to 18° below horizontal.
4. A *Search-Beacon Switch* to convert the search radar system into a beacon interrogator and receiver, and vice versa. Considerable internal complexity is required to perform this conversion by a simple switch operation, but the resultant ease of beacon operation justifies it.

The less commonly used controls are:

1. The *Off-On Switch*.
2. The *Focus Control*.
3. The *Brilliance Control* for adjusting the over-all brilliance of the PPI picture to the best level relative to the ambient illumination.

TABLE 6 3.—WEIGHTS, DIMENSIONS, AND POWER REQUIREMENTS OF AN/APS-10

Unit	Weight, lb	Weight of mount- ing, lb.	A-c power, watts	D-c power, watts	Maximum over-all di- mensions of units, in.			Pressuriza- tion
					H	W	D	
Transmitter-re- ceiver	46	4	185	15-25	$12\frac{5}{8}$	$12\frac{5}{8}$	$20\frac{2}{16}$	Yes
Synchronizer...	13.1	0.8	3	$9\frac{5}{8}$	$6\frac{5}{8}$	$14\frac{3}{8}$	No
Synchronizer power supply	19.4	1.2	150	$11\frac{1}{2}$	9	12	No
Scanner*.....	20	30-50	28	18	18	Feed and r-f lines pres- sured
Radome.....	25
Indicator and visor	8.3	0.3	Included with synch.	$6\frac{3}{4}$	8	$13\frac{1}{2}$	No
Pressure pump..	6.
Trim control in- dicator.....	2.5	$3\frac{5}{8}$	$5\frac{1}{8}$	$4\frac{1}{2}$
and flexible shaft	2.4
Total†.....	142.7	6.3	335	48-78

* These figures apply to the standard AN/APS-10 scanner. A special lightweight (13-lb.) scanner, suitable for most applications, was also developed for AN/APS-10. (See Vol. 1, Sec. 9-12.)

† Approx., depends upon type of installation. This does not include connecting cables, which weigh about 12 lb, or the inverter, weighing about 28 lb. The grand total weight is 189 lb.

4. The *Trim Control* for keeping the axis of the scanner vertical despite varying attitudes of flight caused by changes in loading, etc. It operates with a hand crank. The position of the scanner axis may be determined by means of a bubble-type level indicator.

The two "convenience" controls are the *Range Mark Intensity* and the *Dial Light Intensity* (azimuth scale brilliance) controls.

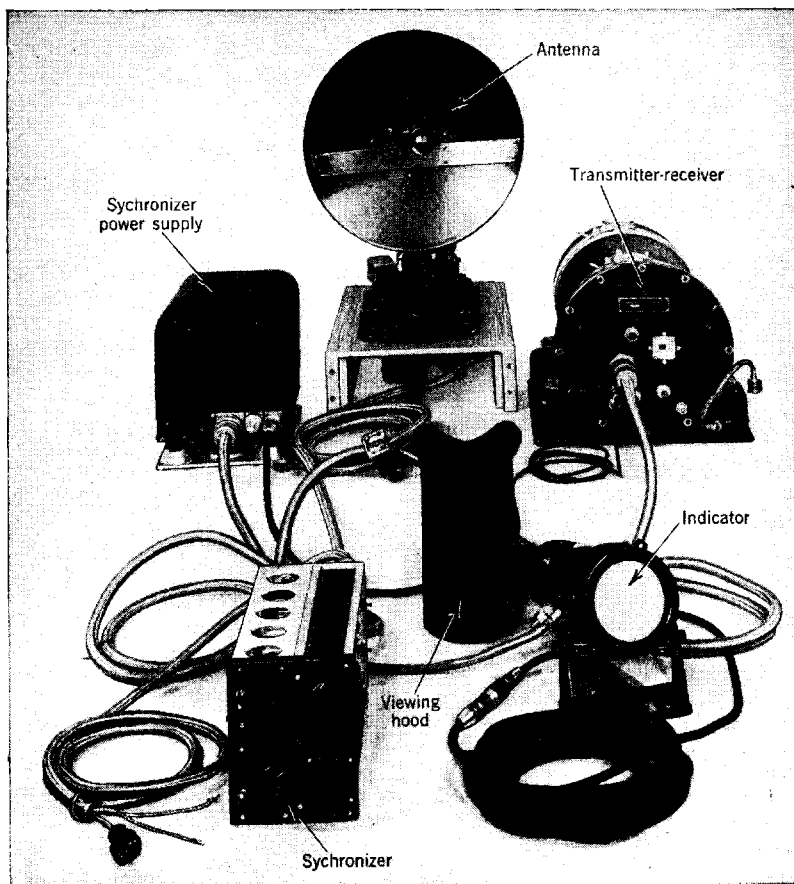

FIG. 6-14.—Components of airborne navigational radar AN/APS-10.

This simplicity of control has been achieved by an increase of internal complexity. Thus the operator does not have to tune the receiver in either search or beacon operation because of the automatic frequency control provided for both. The 3-min warm-up period required for the

modulator tubes is obtained by an automatic time-delay switch. It has been estimated that any trained navigator can learn to operate AN/APS-10 satisfactorily in one hour.

6-5. Characteristics of the AN/APS-10 Radar: II.—The special engineering problems associated with the cramped, extremely variable conditions peculiar to aircraft have been discussed in Secs. 6-1 and 6-2. The way in which each of these problems was solved in the design of AN/APS-10 is described below.

Form.—This radar system consists of five major units: a transmitter-receiver, synchronizer, synchronizer power supply, antenna, and indica-

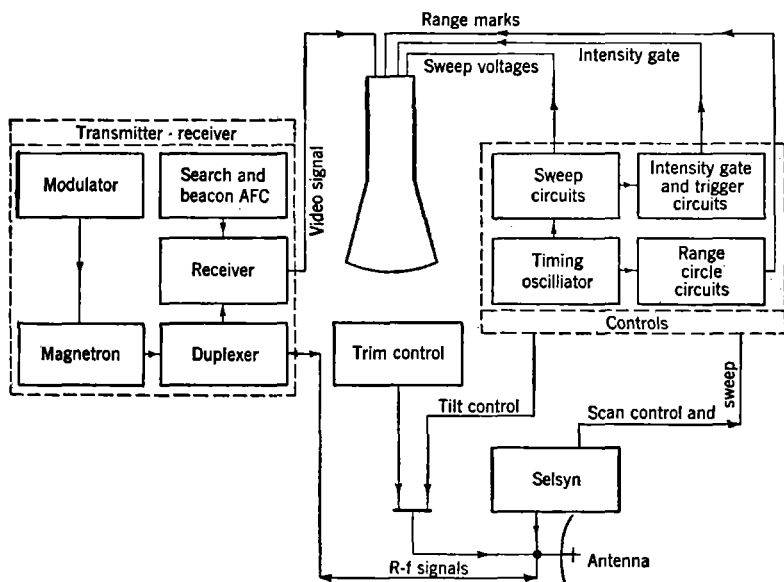

FIG. 6-15.—Block diagram of AN/APS-10.

tor; and two minor components, a trim control box and a pressure pump. Weights, dimensions, and pertinent data about these units are summarized in Table 6-3, and illustrated in Fig. 6-14. Salient technical characteristics are summarized in Table 6-4.

The transmitter-receiver contains the magnetron transmitter, TR switch and mixer, and the two local oscillators (see Fig. 6-15). It includes the modulator and its power supply, a motor-driven time-delay switch and a trigger amplifier for the modulator. Also in this component are the receiver, the AFC unit, and their low-voltage power supplies. The synchronizer unit includes the primary timing circuits for the sweeps, range marks and triggers; the operating controls for the system are on

TABLE 6-4.—TECHNICAL CHARACTERISTICS OF AN/APS-10

Power.....	340 watts of a-c power at 115 v, 400-2400 cycles 80 watts of d-c power at 27.5 v
R-f	
Transmitter frequency.....	9375 ± 55 Mc/sec
Pulse power output.....	10 kw
Receiver sensitivity.....	131 dbw on search, 125 dbw on beacon for minimum discernible signal
Pass band of untuned r-f components.....	9280 ± Mc/sec
Modulator	
Pulser.....	Hydrogen thyratron (3C45)
PRF.....	810/sec on search; 405/sec on beacon
Pulse length.....	0.8 μsec on search; 2.2 μsec on beacon
I-f	
IF.....	30 Mc/sec
Bandwidth of i-f amplifier.....	5.5 ± 1Mc/sec
AFC.....	On search the local oscillator is held 30 Mc/sec above transmitter frequency; on beacon the local oscillator is held 30 Mc/sec below beacon frequency
Indicator	
Indicator.....	PPI with M-S type of azimuth data transmission
Focus.....	Permanent magnet focus is used
CRT.....	5FP14 or 5FP7
Bandwidth of video amplifier.....	3 Mc/sec
Antenna	
Size.....	18-in. paraboloid of 5.67-in. focal length altered to produce a cosecant-squared pattern for 7000 ft
Feed.....	2 dipole
Gain.....	700
Polarization.....	Horizontal
Azimuth beamwidth.....	5°
Scanner	
Scan rate.....	30 rpm
Tilt angle.....	0° to -18°
Trim angle.....	6.5° to -10.5°
System, number of tubes	
Transmitter-receiver.....	31 tubes, 3 crystals
Synchronizer.....	25
Indicator.....	4
Synch-pwr supply.....	6
Total.....	66 tubes, 3 crystals

its front panel. The indicator unit includes the video amplifier in addition to the indicating tube with its deflection yoke and focusing magnet. The synchronizer power supply provides the voltages for both the indicator and synchronizer.

The limited space in aircraft was the reason for designing the set in several small components rather than in a single large one. A separate

transmitter-receiver that could be located near the antenna would permit the use of a short r-f transmission line. Even though the set does have several small components only seven interconnecting cables are required because the synchronizer also serves as a junction box and control box. As some installations may require cable runs as long as 25 ft between the various units, the circuits were designed to allow for appreciable cable capacitance and significant voltage drops. Since the synchronizer is also the control box, it has to be small so that it can be made accessible to a navigator already surrounded by instruments. The use of a separate power supply permits a compact synchronizer. For flexibility of installation the synchronizer mounting is so designed that the control panel may be either vertical or horizontal. A typical installation has been shown in Fig. 6-8.

Weight and Power.—The data given in Table 6-3 show that 189 lb is a reasonable figure for the total installed weight of this equipment.

Miniature tubes and components and lightweight alloys were used and the layout was made compact. Power requirements were reduced to the minimum consistent with satisfactory circuit operation. Of particular importance is the previously mentioned use of a lower pulse-power magnetron output than is commonly used by search-type radars—only 10 kw. The transformers and power-supply filters were designed only for 400-cycle or higher-frequency power supplies.

The achievement of light weight made necessary the omission of certain refinements which include antenna stabilization, sector scan, and ground range sweeps. The point of view adopted was that this equipment could be used for special purposes by the addition of special devices (for example, the use of GPI as an aid to navigation). A trigger and a video output are available for any such attachment. Also there are provisions to accommodate an additional azimuth take-off and external means for reversing the azimuth motor.

Operating Conditions.—AN/APS-10 is expected to operate without trouble at all altitudes up to 30,000 ft. The potential dangers of arcing and of condensation of water vapor are eliminated by pressurizing the transmitter-receiver and the r-f line. The former is contained in a cylindrical tank sealed by a rubber gasket under compression. The cable connectors on the tank are pressurized and a plastic window is placed across the waveguide output. The r-f line is sealed as much as possible and is connected to a pressure pump fitted with a desiccator.

The use of a pressurized container for the transmitter-receiver greatly complicates the cooling problem for that unit. Because most of the power entering the transmitter-receiver is dissipated as heat, the interior of the tank rises to a temperature many degrees above ambient. An internal fan to circulate the air past hot spots and an external fan to

maintain a steady stream of air over the container combine to reduce the rise above ambient to 35°C. Because, however, this system is required to operate indefinitely at 50°C and to withstand an hour's operation at 71°C, the internal components had to be carefully selected to permit operation at temperatures close to 100°C. Oversize resistors and potentiometers and plastics that would not weaken were selected.

At the other extreme are the very low operating temperatures encountered at high altitudes; the set is expected to operate satisfactorily at -55°C. To insure proper operation over this extreme range of temperature, wire-wound resistors and capacitors having predictable temperature coefficients are used for many of the circuits. The reference cavity for beacon AFC is made of invar. Special lubricants are used that will not cause fan and scanner motors to freeze up at -55°C, and that will not be too thin at 71°C. Rubber bellows and the like are of a type that will not crack at -55°C.

The components are designed to withstand, despite their light weight, the severe conditions of vibration and shock encountered in aircraft. This is accomplished by shock-mounting all components except the antenna and trim box. Where possible, as in the transmitter-receiver, the center-of-gravity type of shock mount is used. Shock-mounting is impractical for the antenna which must be made sufficiently rugged to withstand vibration. Pressurized flexible waveguide is used to conduct the radar energy from the shock-mounted transmitter-receiver to the rigidly mounted antenna.

Primary Power Supply.—In order to minimize the effects of the variations in frequency and waveform of aircraft power, rectifier supplies of the full-wave choke-input type are used. Power transformers have been carefully designed to avoid resonances throughout the frequency region of 400 to 2400 cps. Electronically regulated power supplies have been used where necessary to maintain exact voltages or to remove the low-frequency ripple found in the output of many aircraft inverters.

Noise Elimination.—All units are grounded to the airframe; cables and fan blades are shielded. Filters have been inserted in the power leads to fan motors, antenna motors, and all circuits capable of generating r-f energy.

Maintenance.—The contemplated variety and wide dispersion of AN/APS-10 installations made the maintenance problem exceedingly difficult. A defective unit should be quickly replaceable. From this point of view the presence of several radar boxes both simplified and complicated replacement. Small units are easier to remove and to replace, but the defective unit must first be identified.

For ease of maintenance all units have been made independently replaceable with no need of adjustments. Within the transmitter-

receiver, the individual functional units are built upon subchassis, which can easily be removed by undoing a few screws and internal connectors. The receiver and AFC units are so complex that no attempt to repair them should be made in the field. They should be returned to major depots for repairs.

External test points have been provided on the transmitter-receiver and synchronizer power supply to aid in identifying a defective unit. On the transmitter-receiver, these include a test trigger from the modulator, an extra video channel, and a lead to a directional coupler incorporated within the transmitter-receiver. On the synchronizer power supply, pin jacks are provided at which the power-supply voltages can be measured. Further convenient test points are incorporated on many of the subchassis of the transmitter-receiver unit.

These external test points, combined with a routine procedure of inspection, permit maintenance to detect incipient failure and to ensure peak performance.

Future Trends.—AN/APS-10 was designed during 1944. Although a few modifications have been made, its design has remained substantially unchanged. Improvements in the radar field since 1944 suggest that a redesign taking full advantage of existing techniques¹ would result in appreciable improvement of range performance, resolution, and reliability. More specifically, an increase in range performance of perhaps 20 per cent, a decrease in weight of perhaps 25 per cent, and an improved reliability and ease of maintenance could be attained with improved components and techniques.

This system has been selected for detailed analysis as representative of a large class of general navigational-radar systems. Airborne radar has many functions, however, and has taken many other forms to fulfill them. Some of the more characteristic of these are described briefly in the following section.

6-6. Typical Performance of Some Existing Systems.²—The systems described below are offered as a selection from existing equipments that illustrate the radar performance that results from typical choices of basic design parameters. Systems with considerable field service as well as recently developed laboratory prototypes are included so that trends can be observed. The listing is in chronological order of development and includes only developments made in the United States. Attention is given chiefly to navigational functions that have commercial application although all were designed for military purposes. Table 6-5 contains a résumé of some fundamental design parameters of each of these

¹ R. L. Sinsheimer, "A Final Report on AN/APS-10," RL Report No. 874, March 1, 1946.

² By D. Halliday.

equipments; the symbols used in Table 6-5 have the same meaning as those used in Chap. 1. An examination of Table 6-5 shows that the trend in airborne search radars is toward higher power, narrower beams, longer pulses for long-range search and mapping, and shorter pulses when good discrimination is required. Most of the PPI photographs of Chap. 3 were taken with one or another of these equipments.

TABLE 6-5.—SOME DESIGN CHARACTERISTICS OF AIRBORNE RADAR SYSTEMS

	ASB-3	AN/APS-3	AN/APS-15	AN/APQ-7	AN/APQ-13 with large antenna	Rapid scan
λ , cm.....	54	3.22	3.22	3.22	3.22	1.25
G.....	11	700	800 or 1200	1500	1130	4000
Pt. kw.....	5	40	40	50	35	24
D, in.....	24	18	29	190	60	29
	(array)					
τ , * μ sec., pulse length.....	2	1	1 or 0.5	0.4	0.5, 1.13	0.16
PRF, † pps.....	400	650 or 1010	400 or 1600	1350, 624	6000
θ , degrees.....	45	3	3	0.4	1.3°	1.0
Typical installation.....	Wing edge	Nose	Ventral	Special housing	Ventral	Ventral
Scan type.....	Manual	Sector	360° or sector	$\pm 30^\circ$	360° or sector	360°
Stabilized scanner?.....	No	No	Yes	No	No	No
Installed weight, ‡ lb.....	370	775	500	350

* Most of the radars here described also have a 2- μ sec pulse and a suitable repetition rate for beacon interrogation.

† The lower value of PRF is used with the large value of τ .

‡ These weights include cables but not the primary power supply. In certain cases they include the weight of specific military equipment such as bombing computers.

ASB-3.—This is an early search and homing radar, operating at 58 cm (515 Mc/sec). Its antenna consists of an array of reflecting and directing rods since parabolic and similar extended reflectors are prohibitively large for airborne use at these relatively long wavelengths. Because of the relatively wide beam, no automatic scanning provision is made; the antenna is directed by hand. The indicator is a modified A-scope. Land masses to 70 miles and large ships to 30 miles are standard performance.

AN/APS-3.—This Navy 3-cm radar, which has seen extensive field service, is designed for use at altitudes from 500 to 10,000 ft. It has only a sector type of scan with a B-scope presentation. Ranges of 80 nautical miles on single freighters and land mapping to 50 miles have been commonly attained.

AN/APS-15.—This is a Navy 3-cm radar system with two alternate antennas, one providing a cosecant-squared pattern suitable for use at altitudes from 10,000 to 36,000 ft. The other antenna of higher maximum gain provides a cosecant-squared pattern suitable for low-altitude

use. With this equipment, which has had extensive field service, land-mapping can be done to 40 nautical miles, using the high-altitude antenna, and large cities can be seen at 90 miles.

AN/APQ-7.—This Army equipment, which has been in limited field service, is designed as a high-resolution system primarily for high-altitude use (25,000 ft). The antenna is a 16-ft linear array of dipoles housed in a special wing-like nacelle. Scanning is done by a special method which permits the dipole array to remain stationary. Ranges up to 160 miles have been obtained on cities.

AN/APQ-13 with Large Antenna.—The basic equipment of AN/APQ-13 was modified by the addition of a 60-in. antenna for high-altitude operation in large aircraft, as shown in Figs. 6-3 and 6-7. The aim was primarily to provide a high-resolution system and secondarily to reduce the protrusion of the antenna housing below the aircraft fuselage to as small a value as possible. Painting of land is to 70 miles at 20,000 ft and 35 miles at 5000 ft. The antenna housing protrudes only 10 in. below the keel line of the aircraft.

Rapid Scan.—The "Rapid Scan" system is a recent laboratory development. It produces a presentation of very high resolution at 700 scans per min on a cathode-ray tube of very short persistence. Although the range is limited by water-vapor attenuation, it represents a somewhat new philosophy of design which will be extremely useful where very fast moving aircraft are involved. The present land-mapping range is about 9 miles on a dry day but this can probably be improved.

6-7. Economic Aspects of Airborne Radar.¹—This discussion deals with quantities whose magnitudes cannot be known accurately. Some of them have been guessed at; others have been obtained from a TWA engineering report, ANOA.² A quotation from ANOA follows:

All cost analyses shown in this report are to be taken as rough estimates representing about the average condition.

At the present time delays and cancellations on a fleet equivalent to forty-five DC-3's cost TWA a loss of \$250,000 per month [\$67,000 per aircraft per year], on a survey made of operations between January and July of 1945. By far the greatest cost was involved in weather cancellations and delays, this amounting to \$165,000 [\$44,000 per aircraft per year] of the \$250,000. This loss can be greatly reduced by providing better air navigation, instrument landing, and traffic control.³

Initial Cost of Installed Equipment.—Since it is assumed that the airborne radar of the near future will resemble AN/APS-10 more closely

¹ By H. Fahnestock, Jr.

² R. C. Ayres and H. K. Morgan, "Air Navigation Operational Analysis," TWA Engineering Report 650, Nov. 10, 1945.

³ ANOA, p. 4.

than it will any other present set, the specifications for this system are used as a basis for the discussion.

In January 1945 the airlines of the United States were operating between 500 and 600 aircraft, and it is expected that this number will increase to about 1000 by 1947. If airborne radar is to be used at all on the domestic air lines, it is to be expected that several hundred installations will be made. The Army Air Forces had an order during the war for 5000 AN/APS-10 units at \$8000 each. Balancing the smaller peacetime numbers against peacetime economies of production it would appear that this figure, also assumed by ANOA, will cover the price of the equipment plus the cost of installation. If the set were depreciated over a period of five years, the cost of depreciation would amount to \$1600 per aircraft per year. If very careful planning were done in advance, it should take a four-man crew about three days to install the system.

Costs of Flying, Operation, and Maintenance.—Unless otherwise stated, all further cost figures are for one aircraft per year. From ANOA we learn that it costs \$30 per year to fly one pound of extra equipment. Other airlines find that this cost may be \$200. The total installed weight of AN/APS-10, with all necessary auxiliary equipment, is about 190 lb. In addition, because the radome drag may reduce cruising speed by 3 mph, in order to maintain the same margin of safety in range, a DC-3 must carry 60 lb of extra fuel on a 6-hr flight, and a DC-4 170 lb on a 10-hr flight.

Both a radio operator and a navigator are now normally part of the crew of a large ship in international service, and the radar set would be operated by one of these—probably the navigator. If the crew consists only of a pilot and a copilot, as in a DC-3, the equipment would be operated by the copilot. AN/APS-10 was designed with this in view.

In neither case is an extra crew member needed, but those who do operate the set must be given special training, about 25 hours on a ground trainer, followed by studies of oscilloscope photographs. The operator should then have some 20 hours' further work in the air on oscilloscope interpretation. Many former radar navigators in the Army Air Forces are now available who would need very little further training to qualify as civilian air navigators. This subject is discussed in greater detail in Sec. 3-3.

Maintenance would logically be done by the present radio maintenance personnel after additional training. An experienced aircraft radio-man would require about 6 months' schooling in general radar principles and in servicing AN/APS-10. But here again experienced men are available from the Army Air Forces.

The maintenance work could be done in existing radio repair shops

if they were provided with special radar test equipment and supplies of spare parts. The time that the aircraft is grounded for radar maintenance should not exceed that for the radio maintenance, but actually the number of man-hours necessary would be somewhat greater simply because of the greater complexity of equipment and the short life of certain special tubes. In ANOA it is stated that maintenance costs of the radar are \$600 per year.

Ground Beacons.—The capabilities of the radar set cannot be fully realized unless beacon stations are established. It is not expected that their costs will fall upon the airlines; more probably some government agency such as the Civil Aeronautics Authority would install and maintain them, just as it now does visual beacons and other ground accessories to flight. Nevertheless the matter is mentioned here for completeness.

During the war 1000 ground-based beacons (AN/CPN-6) were ordered by the Navy at \$30,000 apiece. About half this figure represents the cost of the beacon alone and the remainder is the cost of an abundant supply of spare parts. These beacons were more powerful than would be necessary or desirable for the application under discussion. Let us assume that each beacon and its spare parts may be purchased for \$20,000; allow \$10,000 more for the purchase or lease of a site and the construction of a road, power line, and equipment shelter. Let us further assume that one man can maintain 3 beacons and their spares at a cost of \$6000 a year. The initial cost per beacon station would then amount to \$50,000, or \$5000 per year if amortized over a 10-year period. The cost of maintenance would increase this figure to an annual cost of \$7000 per beacon station.

When two beacons are placed at each location the spare could be arranged to turn on whenever the first beacon failed. The response of each beacon could have some peculiar characteristic by which an airplane observer could identify that particular beacon.

TABLE 6-6

	At \$30/lb per yr		At \$100/lb per yr	
	DC-3	DC-4	DC-3	DC-4
Cost of equipment amortized over 5-yr period.....	\$1,600	\$ 1,600	\$ 1,600	\$ 1,600
Cost of flying 190 lb of equipment.....	5,700	5,700	19,000	19,000
Cost of flying extra fuel; 6-hr trips on DC-3, 10-hr on DC-4.....	1,800	5,100	6,000	17,000
Maintenance.....	600	600	600	600
Cost to airline per year per airplane.....	9,700	13,000	27,200	38,200

Net Cost and Savings.—The above costs to an airline per airplane per year are tabulated for a DC-3 and a DC-4 using two values for dollars per pound per year in Table 6-6.

There are no figures in ANOA which correspond directly with these. There is one of \$12,440, the greater part of which is radar cost, but it includes the cost of some other equipment as well. The above costs are to be compared with expected decreased costs of \$28,000, about one-half of which can be fairly ascribed to the use of radar equipment.¹

If dollars were the sole consideration it appears that there would be no particular advantage in installing AN/APS-10 in commercial aircraft. However, the increase in good will and respect for air travel which would go hand-in-hand with progressive increases in safety and dependability might far outweigh the foregoing economic considerations.

¹ ANOA, pp. 24, 30.

PART III

GROUND-BASED RADAR

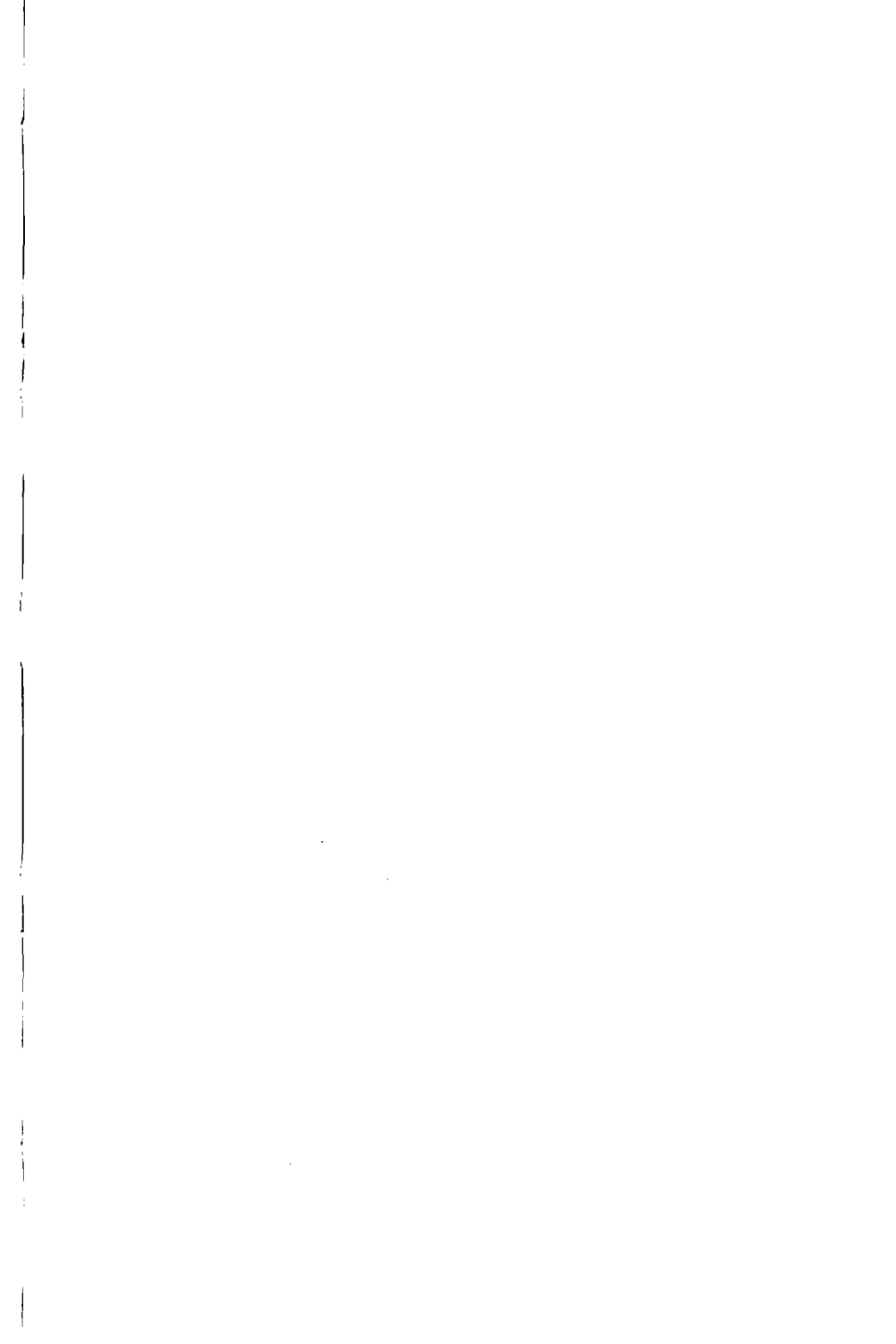

CHAPTER 7

TYPES OF GROUND-BASED RADAR AND SPECIAL EQUIPMENT

BY M. A. CHAFFEE, J. S. HALL, H. B. ABAJIAN, H. P. STABLER,
G. C. COMSTOCK, A. G. EMSLIE, J. B. PLATT, R. M. WHITMER,
J. M. STURTEVANT, AND R. H. MULLER

SEARCH AND AUTOMATIC-TRACKING RADARS

The following two chapters are intended to give the reader insight into the problem of air traffic control and landing. The basic navigational aids required for a reasonable solution of this problem may be used in any one of many possible forms. The rather heterogeneous collection of aids described in this chapter are molded into several possible patterns in the chapter that follows.

7.1. A Long-range Microwave System.¹—There appears to be a peacetime need for a radar set with long range and high resolution which should be able to deal with large numbers of aircraft, give a complete over-all picture of the air traffic, and permit detailed examination of the activity in a small selected area. High resolution would allow aircraft flying close together to be seen separately on the PPI and would reduce the possibility of target confusion due to ground signals.

Let us first pursue the line of thinking which a radar designer would probably follow if he were to design a long-range microwave ground-based radar.

Specifications.—The specifications of such a microwave radar may be summarized briefly as follows. It should be capable of detecting a single four-engined airplane above the horizon up to an altitude of 30,000 ft and out to a range of about 200 miles. The rate of scan is 4 rpm; at least 15 pulses per scan should strike each target. Resolution in range and azimuth should be as high as is compatible with these specifications for range and rate of scan.

An inspection of a coverage diagram such as that shown in Fig. 7-6 indicates that two separate antenna systems might be used. The long-range system would produce a single lobe with a vertical spread of 3° . If the axis of this lobe were elevated 1° above the horizontal, such a beam would satisfy the range-height specification at low elevation angles. The short-range antenna system must have a beam that is fanned at least 25°

¹ By M. A. Chaffee and J. S. Hall.

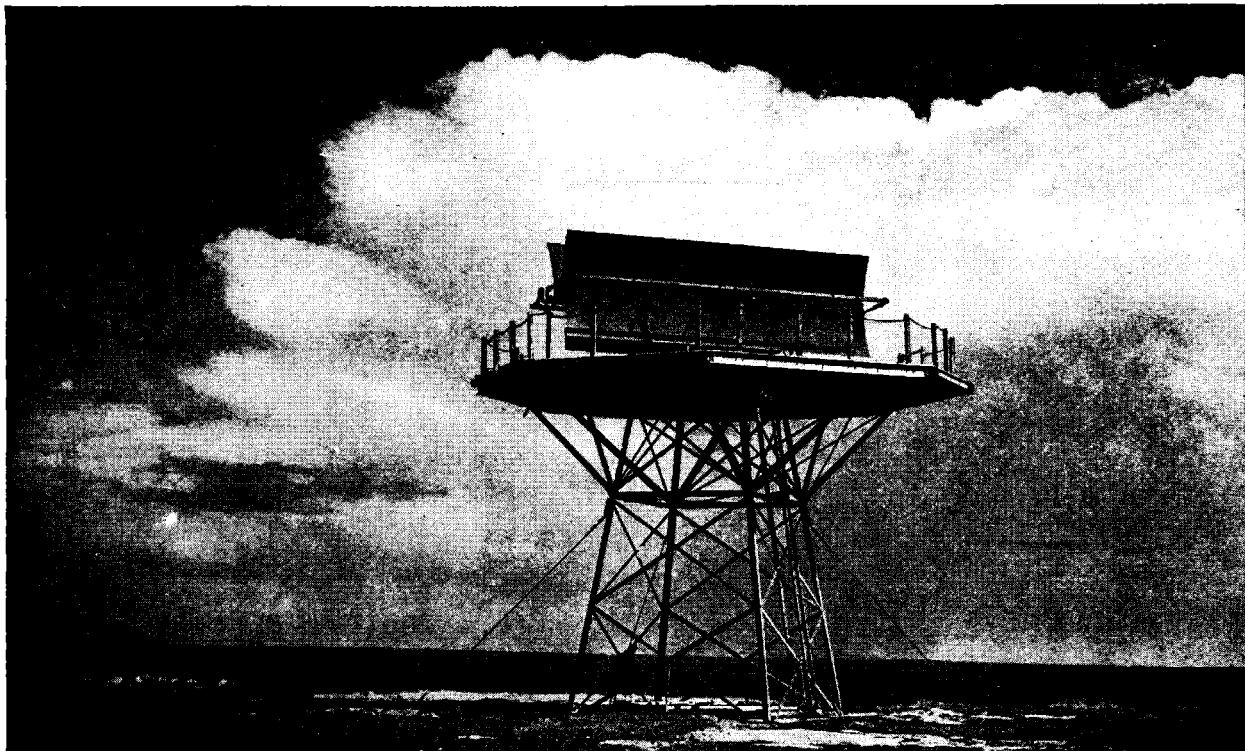

FIG. 7-1.—A microwave radar antenna mounted 85 ft above the water on the south coast of England.

in the vertical plane to give a reasonable approximation to the required high coverage. One satisfactory way of doing this is to shape the dish in the vertical plane in such a manner as to obtain the required high coverage. The feed could in this case consist of a linear array of dipoles. The horizontal dimension of the two reflectors is made identical in order that the angular width of the signals remain constant as an airplane passes from one antenna beam to the other.

These two antennas could be placed back to back on the same mount as shown in Fig. 7-1. The signals picked up by either antenna might be switched to any indicator. Aside from this consideration all other components are duplicated. The antenna mount should be installed high enough above the ground to permit the antenna beams to clear near-by obstacles, such as trees, buildings, and hills. If the antenna were installed 100 ft above the ground, an airplane at 30,000 ft would be on the radar horizon at 255 statute miles.

Since the intent here is to indicate one approach in designing a long-range radar system, only that portion of the system which gives coverage to about 200 miles will be considered.

Choice of Wavelengths.—The choice of wavelength is perhaps the most important factor in radar design; each variable and its relationship to wavelength in the general range equation will be discussed in turn. A detailed analysis of the choice of wavelength for this kind of system is given in *Radar System Engineering*, Vol. 1, Radiation Laboratory Series.

The expression for the maximum range R_{\max} (Sec. 1-3) at which a signal from a target of cross section σ can barely be detected under search-lighting conditions may be written as

$$R_{\max} = (C\sigma)^{1/4} \left(\frac{P_T}{P_R} \right)^{1/4} \left(\frac{A}{\lambda} \right)^{1/2} \quad (1)$$

when P_R , the receiver sensitivity, is substituted for S_{\min} .

If the wavelength is small compared to the dimensions of the aircraft, the value of σ is nearly constant. With wavelengths that approach the dimensions of the aircraft impractically large antenna arrays must be used to obtain satisfactory angular resolution. It may be assumed here, therefore, that σ is constant.

We next consider how the ratio of the available transmitter power to the receiver sensitivity changes with wavelength. Since the maximum range varies directly as the fourth root of this ratio, the quantity $(P_T/P_R)^{1/4}$ is tabulated for different wavelengths in the last column of Table 7-1. Only the most optimistic values for P_T and P_R in early 1945 are presented.

It is evident from an inspection of the final column in Table 7-1 that the largest values of $(P_T/P_R)^{1/4}$ (and therefore maximum range) occur at wavelengths of 10 cm or longer.

TABLE 7-1.—EFFECT OF $(P_T/P_R)^{1/4}$ ON THE RANGE OF A RADAR SYSTEM

Band	Wavelength, cm	Peak power P_T , kw	Recvr. sens. P_R , $\mu\mu$ watts	Range factor $(P_T/P_R)^{1/4} \times 10^4$
K	1.25	25	0.20	1.9
X	3.2	50	0.13	2.5
S	10.7	1000	0.08	6.0
L	25	1000	0.05	6.7
P	100	500	0.03	6.4

The last factor in the range equation $(A/\lambda)^{1/2}$ is closely related to both the required range and coverage of the radar system. It will be recalled that in addition to the 200-mile range requirement the set must scan at 4 rpm and that a minimum of 15 pulses must hit each point target per scan. The range requirement limits the pulse repetition rate which, when combined with the rate of scan and the required number of hits per scan, defines the horizontal beamwidth of the antenna. The vertical beamwidth is 3° .

If the radar is to have a useful range of 200 statute miles, the pulses must be spaced at least 200×10.74 , or 2148 μsec apart. Because it is necessary to allow additional time for the indicator circuits to recover between successive sweeps, the interval between pulses should be about 2500 μsec . This spacing corresponds to a repetition rate of 400 pulses per sec. Fifteen pulses occur in $\frac{15}{400}$ or 0.037 sec. Since 4 rpm is equivalent to an angular rate of 24° per sec, the antenna beam progresses $0.037 \times 24^\circ$ or 0.9° in 0.037 sec. The horizontal beamwidth must therefore be at least 0.9° wide. If it is wider than 0.9° , an unnecessary loss in resolution would result.

An antenna beam that is 0.9° wide and 3° high, then is compatible with the requirements of this early-warning problem. Table 7-2 gives the approximate antenna dimensions required to produce a beam 0.9° wide and 3° high at different wavelengths.

TABLE 7-2.—EFFECT OF $(A/\lambda)^{1/2}$ ON THE RANGE OF A RADAR SYSTEM

Band	Wavelength		Dimensions of reflector		Range factor $(A/\lambda)^{1/2}$
	cm	ft	Vertical, ft	Horizontal, ft	
K	1.25	0.041	1	3	8.6
X	3.2	0.10	2.5	8	14.1
S	10.7	0.35	8	28	25.3
L	25	0.82	19	66	39.1
P	100	3.26	75	264	77.9

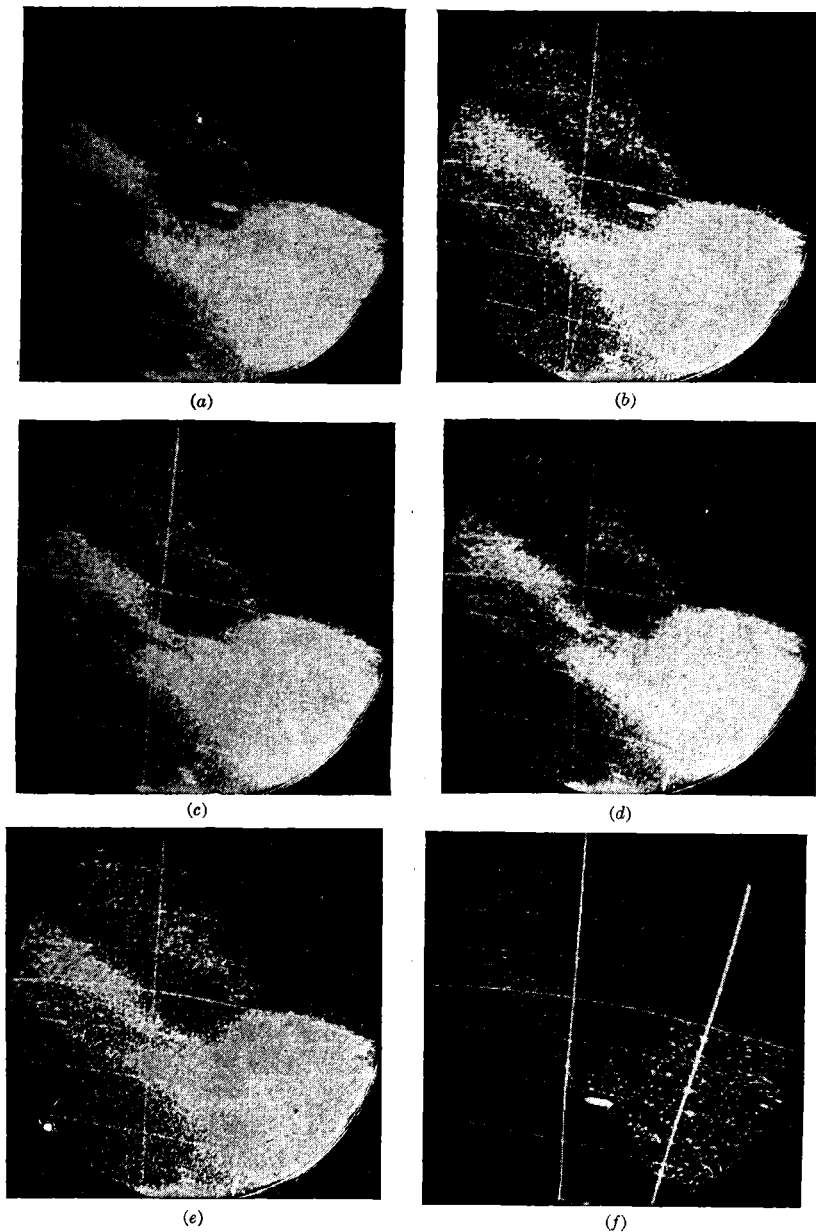

FIG. 7-2.—An airplane passing over a storm area. Photographs taken at 15-sec intervals. Range lines 2 miles apart. Anticlutter circuits bring out the signal from airplane in (f) when it is still over this area.

The data in Tables 7-1 and 7-2 indicate that a wavelength of 25 cm or longer should be used if maximum range is the only consideration. Otherwise, the wavelength used for this set should not be longer than about 25 cm or shorter than 8 cm. The reasons for this are as follows.

1. The mechanical difficulties of building and mounting reflectors larger than 25 ft in one dimension increase rapidly with increasing sizes.
2. Ground reflections become appreciable at longer wavelengths and tend to introduce objectionable nulls and peaks such as are pronounced at 10 cm only in propagation over water.
3. If ground reflections do exist, the height of the antenna must be increased in the same ratio as is the wavelength in order to maintain the same low coverage. Also, when shorter wavelengths are used, there is less angular separation of vertical lobes, permitting better continuity of signal strength with change of elevation angle. These effects are described in Sec. 10-1.
4. At wavelengths longer than 25 cm, rain clouds or storm areas dangerous to aircraft may be missed entirely. At wavelengths shorter than 8 cm, such areas frequently obscure otherwise useful information. A series of photographs of an expanded PPI showing a local storm area and an airplane flying above it is presented in Fig. 7-2. The radar was operating at a wavelength of 10 cm. Just prior to the expected reappearance of the airplane from over the area of the disturbance, anticlutter circuits in the receiver were switched on.
5. The available power and receiver sensitivity at wavelengths shorter than 8 cm require large dishes for obtaining adequate range. This makes the horizontal beamwidth too small and reduces the number of pulses hitting each target per scan to less than 15. The power and receiver sensitivity given for 10.7 cm in Table 7-1 is now available down to 8.0 cm.

The wavelength region between 8 and 25 cm therefore seems practical for an early warning set. If a large number of pulses per target are required (as in the case of MTL, moving target indication, Sec. 7-9) a wide horizontal beamwidth is indicated and a wavelength nearer 25 than 8 cm may be found desirable. If, on the other hand, fewer pulses on a single target are sufficient, the wavelength could be nearer 8 cm.

Let us assume that a wavelength of 10.7 cm is to be used and that the reflector is 8 ft high and 24 ft wide with an area of 192 ft². Since at 10 cm, $P_R = 0.08 \times 10^{-12}$ watt (Table 7-1), the rate of scan is 24° per sec, the PRF is 400, and the beamwidth is 0.9°, these values may be substituted in Eq. (3) of Sec. 1-3 to evaluate S_{min} . We then have

$$S_{\min} = \frac{90}{400^{3/2}} \left(\frac{24 \times 8}{0.9} \right)^{3/2} (0.08 \times 10^{-12}) = 5 \times 10^{-12} \quad \text{watt.}$$

When we substitute this value in Eq. (2) of Sec. 1-3 R_{\max} is found to be 225 statute miles. This value is 12 per cent larger than that attained in the field, and is considered a reasonable agreement for a computation of this kind.



FIG. 7-3.—An off-center PPI.

Although the range would be increased by lengthening the pulse, it is desirable to limit the pulse length to 1- or 2- μ sec duration. Longer

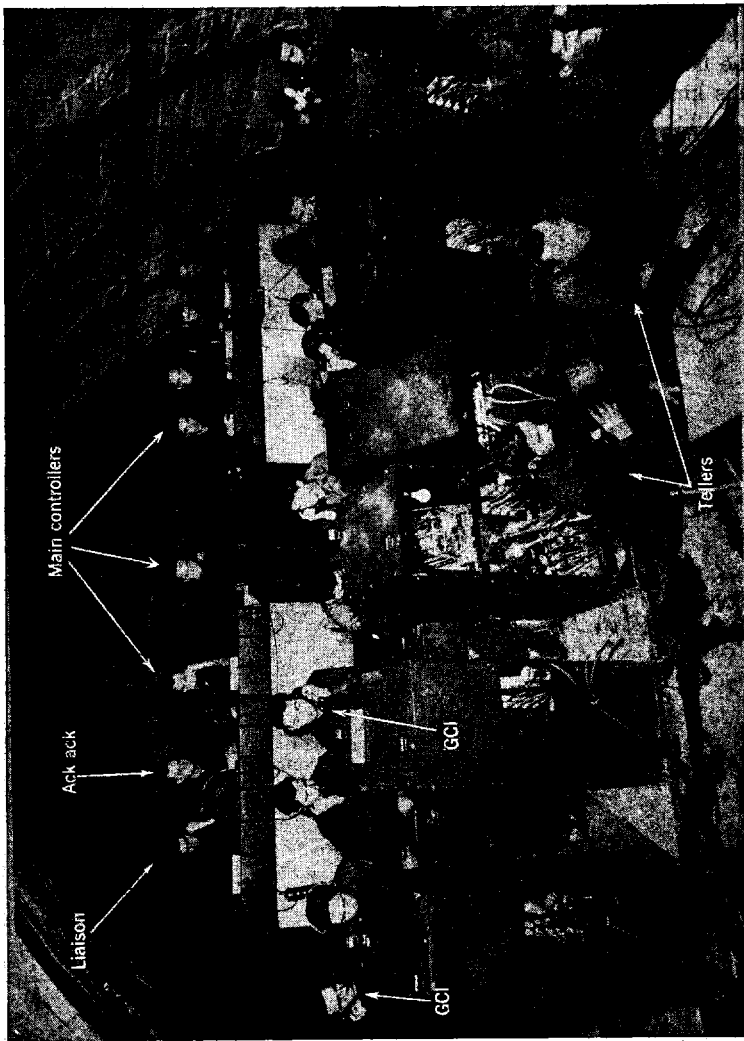

FIG. 7-4.—The interior of a filter room used by the AAF Ninth Tactical Air Command, Aachen, Germany. GCI means Ground Control of Interception.

pulses would make it more difficult to resolve airplanes close to one another and shorter pulses might cause serious loss in range.

Radar information must be presented in such a way that the operators have a clear picture of all activities in a particular area. In the early

Army procedure, each radar operator relayed the observed position of aircraft to a plotter at a central filter board. This was a large table with the map of the area drawn on it. The aircraft positions obtained from all

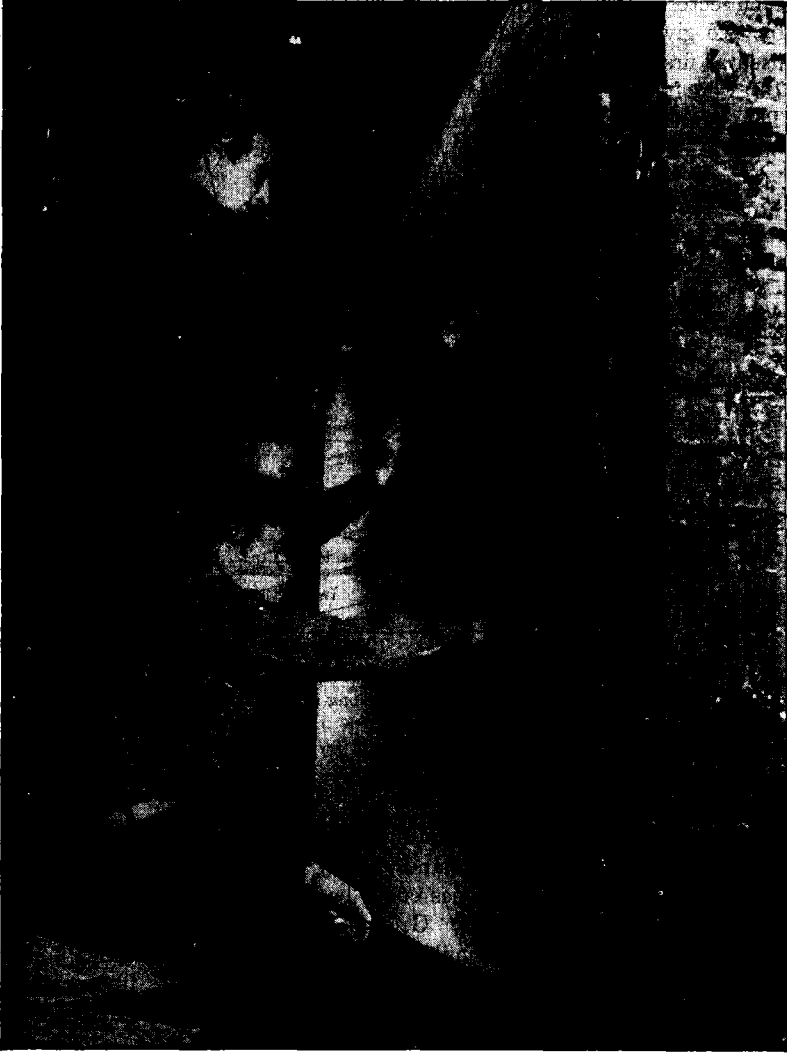

FIG. 7-5.—Plotters marking the back of a plotting board at Grayfriars, England.

radars in the area were represented by small markers. The central filter room correlated this information with the known operations and distinguished between hostile and friendly aircraft.

It was proved during the war that a long-range microwave radar scans such a large area and detects so many aircraft that it is necessary to divide the area into several sectors with one radar operator observing each sector. Because the B-scope is capable of presenting areas bounded by two given azimuths and two given ranges, a number of them were used at first with each radar set. More recently, off-center PPI's (Fig. 7-3) were found to be more satisfactory and were substituted for B-scopes. The combination of a microwave PPI radar and a height-finding radar provided the basic information for an excellent up-to-the-minute picture

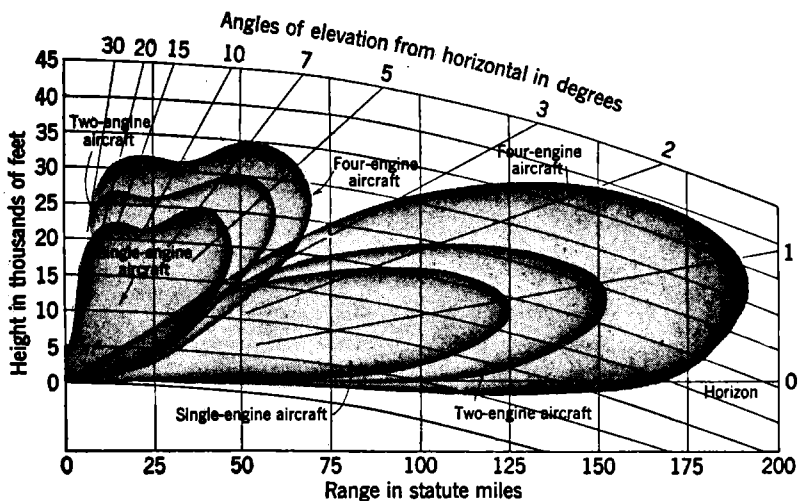

Fig. 7-6.—Coverage diagram of a long-range microwave radar.

of air activity up to 30,000 ft and out to a range of 150 or 200 miles. Figures 7-4 and 7-5 are examples of a filter room and plotting board used for this purpose.

The coverage pattern shown in Fig. 7-6 was first constructed from data obtained by operators in Holland. They found from experience that airplanes of the indicated types could be followed continuously if they were within the shaded areas. Groups of high-flying four-motored airplanes were followed to 250 miles (on the second sweep). Buzz bombs (V-1's) were frequently detected at the horizon 70 miles from one set located near Dover, England. A D-day photograph of a PPI is shown in Fig. 7-7.

7-2. Automatic Tracking Systems.¹—The automatic tracking of aircraft by radar has attained a high degree of precision and may be

¹ By H. B. Abajian.

applicable to navigational problems such as ground control of approach (GCA), and accurate positioning of aircraft.

The basic components of an automatic tracking radar differ from those of a nontracking system by the addition of a scanning antenna, a

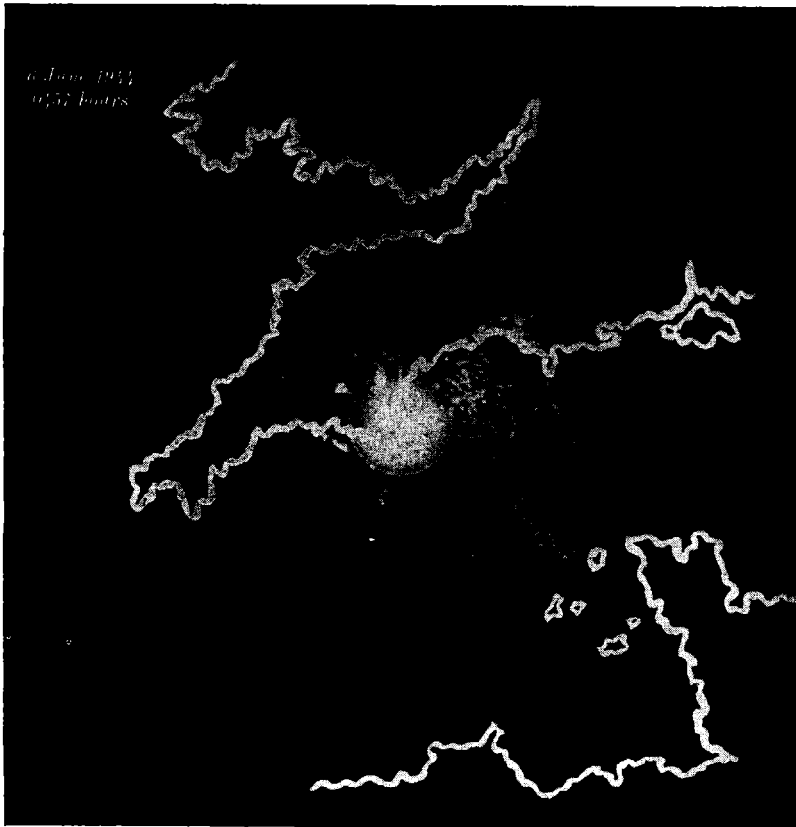

FIG. 7-7.—PPI on D-day. One large group of aircraft has just left the coast of England; another large group is about to pass over the Cherbourg Peninsula. Aircraft already over the peninsula and others returning to England are at the right. The air traffic is moving in a counterclockwise sense.

gating system in the receiving channel to isolate the desired signal, and a servomechanism system consisting of an error signal detector, a resolver, and a power amplifier.

Scanning Techniques.—An antenna with a dipole feed as shown in Fig. 1-2, Chap. 1, is considered first. This arrangement produces a radiation pattern in space consisting principally of a single lobe. If the lobe axis were offset from the axis of the paraboloid, the pattern of Fig.

7-8a would result. One way of "squinting" the lobe is to displace the dipole from the paraboloid axis. If the displaced dipole were rotated about the axis of the paraboloid, the pattern in a plane containing the paraboloid axis and the line of sight to the aircraft would be as in Fig. 7-8b. The rotating lobe axis describes a cone around the paraboloid axis; hence, the name conical scanning.

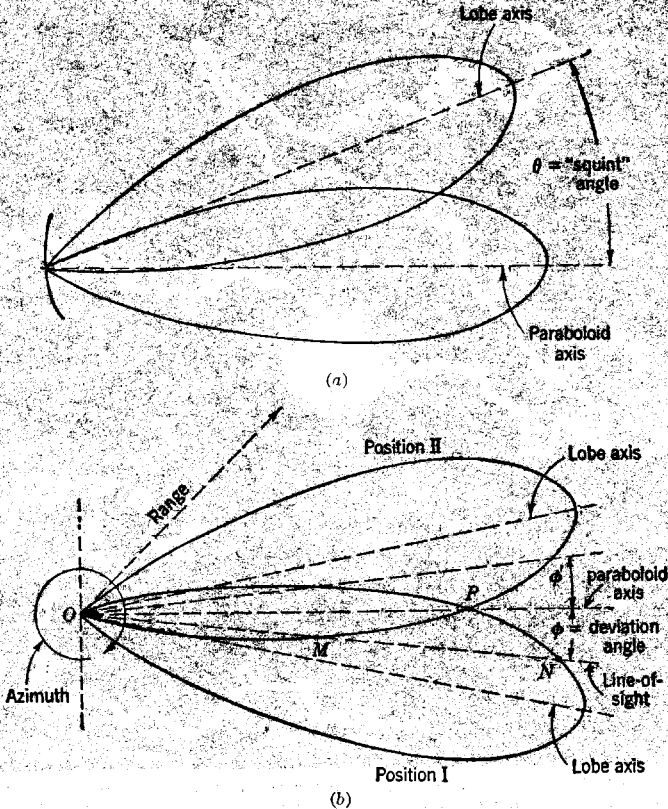

Fig. 7-8.—Polar plot of intensity in one plane showing (a) lobe axis offset from the paraboloid axis and (b) rotating offset lobes.

In Fig. 7-8 let the line OMN be the line of sight to the aircraft, angle ϕ being the deviation from the paraboloid axis. When the lobe is in position I, the vector ON is a measure of the signal intensity received from the aircraft. When it is in position II, the vector OM is a measure of the signal intensity. For one complete rotation of the dipole, therefore, the signal intensity varies from a maximum value, ON , to minimum, OM . It can be shown that the variation from maximum to minimum is

sinusoidal with a frequency equal to the number of rotations per second of the dipole drive shaft. The output of the receiver would be as shown in Fig. 7-9a.

Suppose the line of sight to the aircraft were coincident with the axis of the paraboloid. Then the received signal for both positions I and II

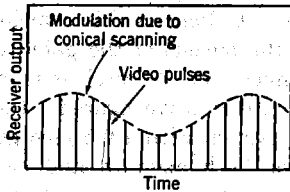

FIG. 7-9.—(a) Video modulation when an error exists.

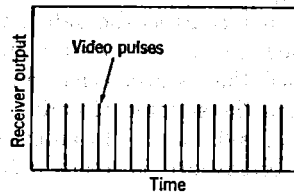

FIG. 7-9.—(b) Constant-amplitude video when no error exists.

would be of equal intensity as represented by vector OP and the receiver output would be as in Fig. 7-9b. The percentage modulation of the received signal, therefore, is a measure of the deviation of the line of sight to the aircraft from the axis of the paraboloid.

Gated Receiver.—In order to confine the tracking of the antenna to the selected aircraft only, the receiving system must isolate the signal from that aircraft. Angular isolation is provided by the directivity of the

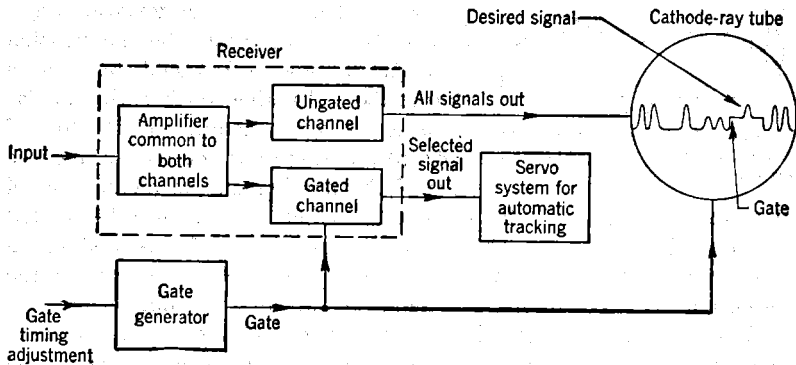

FIG. 7-10.—Block diagram of the gating system.

antenna. Range discrimination, however, must be obtained from the timing circuits of the system. These provide a rectangular pulse, called a "gate," coincident in time with the desired signal to switch on a normally cutoff section of the receiver. Since the range to the aircraft changes continuously, the timing of the gate must also be variable to maintain coincidence of the aircraft signal and the gate. A simultaneous display on a cathode-ray tube of both the gate and the received signals

gives a continuous monitor on the position of the gate with respect to the selected signal and easily permits continuous coincidence. Figure 7-10 is a block diagram of a gating system.

Gate tracking can be accomplished automatically by "range scanning" in much the same manner as conical scanning is employed in automatic angular tracking. The resultant error signal is used to operate a motor that controls the gate timing. As long as this coincidence is maintained on the cathode-ray tube, the output of the gated channel (also called the "servomechanism channel") of the receiver is only the signal from the selected aircraft. A representative figure for the width of the gate is $0.6 \mu\text{sec}$. In an existing system with a $0.6 \mu\text{sec}$ gate, the antenna beamwidth is about 1.75° for both azimuth and elevation. From these figures the dimensions of the volume in space, at any given range, to which the gated channel of the receiver is sensitive can be calculated. The price that is paid for such selective response is reflected in the difficulty in making the original pickup, particularly at high angles of elevation.

Servomechanism.—In the discussion on conical scanning it was shown that any deviation of the aircraft from the axis of the paraboloid would result in modulation of the received signal, the frequency of modulation

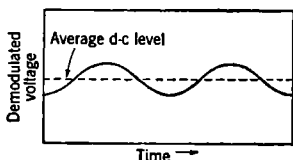

FIG. 7-11.—Error signal after demodulation of video when an error exists.

being determined by the rate of rotation of the dipole. Referring to Fig. 7-8, if ϕ' instead of ϕ had been the deviation angle it can be shown that the modulation envelope of Fig. 7-9 would have been shifted 180° . In other words, if the angular deviation is kept constant and the line of sight to the aircraft is rotated around the axis of the paraboloid, the modulation of the received signal will have constant amplitude but will be shifted continuously in phase. The phase and amplitude of this modulation compared to standard azimuth and elevation voltages determine the resolution of the error signal into azimuth and elevation components.

Further demodulation of the video output of the receiver gives a voltage as shown in Fig. 7-11; the amplitude and phase varies as the vector sum of the azimuth and elevation deviations from the axis of the paraboloid. Since both azimuth and elevation deviations are included in the above error voltage, it must be resolved into azimuth and elevation components. Each component voltage is then amplified as necessary and applied to its appropriate motor on the antenna which is driven in the direction of the aircraft. When the axis of the paraboloid passes through the aircraft, the error signal falls to zero and the antenna-driving motors stop. Because an aircraft moves continuously in space, however,

the antenna must move continuously to keep azimuth and elevation deviation as near zero as possible.

Data Transmission.—There remains only the question of transmission of the data to the communication center. Single and multispeed synchros geared to the antenna provide precise angular data; single and multispeed synchros geared to the controls which position the ranging hairline as well as the range gate provide precise slant-range data. If desired, potentiometers can be substituted for the synchros, or both can be used simultaneously.

Auxiliary Equipment.—In order to make full use of the information available at the system described, the following auxiliary equipment would be desirable.

1. Suitable PPI's for initial search or to aid in providing homing information.
2. Range, azimuth, elevation, and altitude synchros grouped and photographed by a constant-speed camera to make a permanent record of the course of the aircraft. The disadvantage of such a system is that considerable computation is necessary in order to reconstruct the course and to determine rates.
3. An altitude converter, solving the equation $H = D \sin E$, where H = altitude, D = slant range, and E = elevation angle, to give the true altitude of an aircraft above the radar position.
4. An automatic plotting board to trace the ground course accurately on a map. In addition to the ground plot, the plotting board can be made to include the following aids: (a) timing markers to permit easy calculation of rates at any point at any future time; (b) rate meters so that rates can be read instantaneously; (c) a ground-bearing meter to indicate the bearing of the ground course. Drift can then be determined easily from this indicated bearing and the compass bearing in the aircraft.
5. A computer to give flying time, course, and glide angle for bringing an aircraft to the airport.
6. A parallel receiving system, tuned to a beacon transponder in the aircraft, to receive only coded beacon responses.

HEIGHT FINDERS

BY H. P. STABLER

7-3. Height-finding Methods. *Introduction.*—Radar height finders are devices for measuring the slant range of an airplane and the elevation angle of the radiation path between the airplane and station. Of these two factors, the angular measurement is peculiar to height-finding whereas the measurement of slant range presents no unusual problem.

Except at short ranges the elevation angle is small and difficult to measure to the required precision. For example, most civilian airplanes today fly at heights under 10,000 ft which means that at 10 miles, 25 miles, and 75 miles the elevation angles to be measured are generally smaller than 11° , 4.2° , and 1.1° , respectively. An uncertainty of only 0.1° at 50 miles causes a corresponding height uncertainty of about 500 ft. These figures suggest that either an exploratory radiation beam that is very thin in the vertical dimension must be used with the height finder or else some means

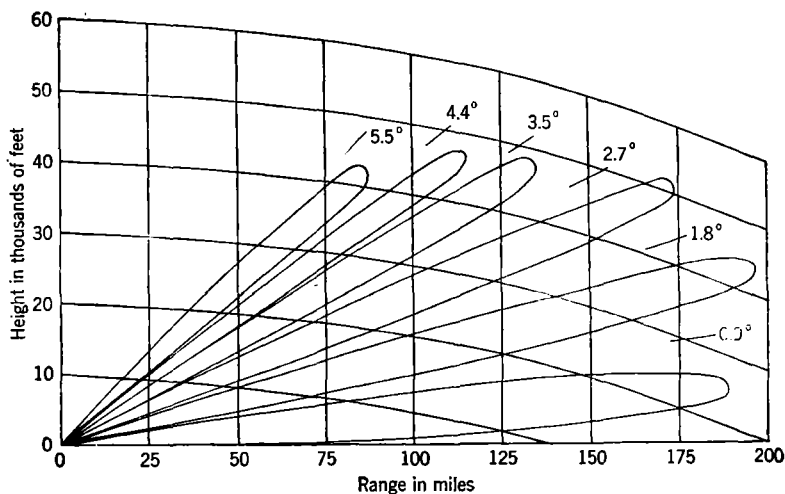

FIG. 7-12.—Vertical coverage diagram of a long-wave set. The frequency is 100 Mc/sec and the antenna is placed 300 ft above a flat reflecting surface, in this case the sea. The lobes show the regions in which airplanes can be detected. (Courtesy of United States Army.)

must be provided by comparison of intensities of echoes for accurate interpolation within a beamwidth.

Height is calculated by the relation

$$H = 5280R \sin \theta + \frac{R^2}{2} + H_0. \quad (2)$$

In this expression H is the height in feet above sea level, R the slant range in miles, θ the elevation angle of the radiation path as measured at the station, and H_0 the height in feet of the station above sea level. The term $R^2/2$ is an approximate correction for the curvature of the earth and the slight curvature of the radiation beam due to normal refraction. Usually the height calculation, including the curvature correction, can be incorporated directly in the indicator design.

Long-wave Methods.—Radars employing frequencies between 100 and 300 Mc/sec have beam patterns that are characterized by a multiple-lobe structure. A typical height-range antenna diagram of a 100-Mc/sec set,

used primarily for search but also for height information, is shown in Fig. 7-12.

The radiation nulls, which are spaced a degree or so apart in elevation, result from interference between energy coming directly from the antenna and energy which first strikes the ground and is then reflected. The beam is rotated continuously in azimuth but it is fixed with respect to the vertical. Because of the fine structure of the pattern, the intensity of the echo from an airplane flying a radial course changes periodically with

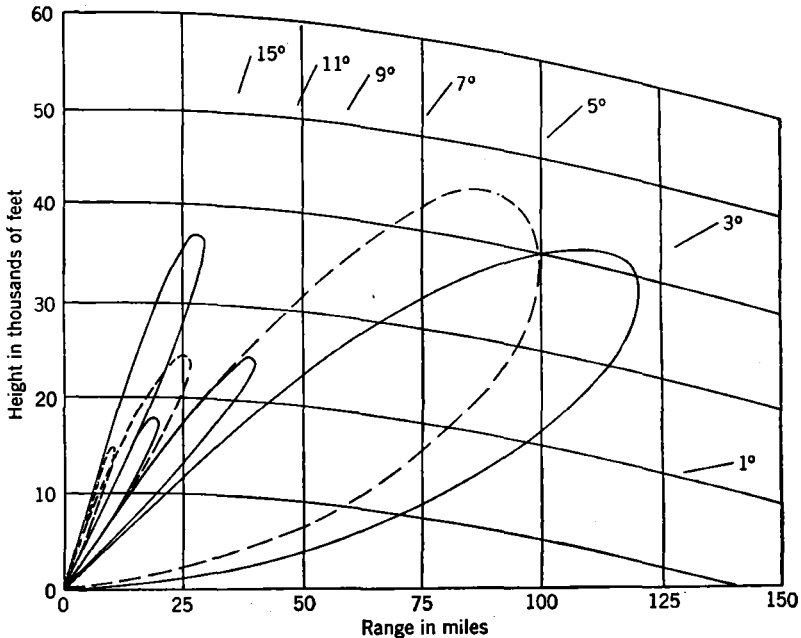

FIG. 7-13.—Vertical coverage diagram of a long-wave set employing lobe-switching. Two different patterns are drawn. The two patterns are used alternately on successive pulses and the ratio of alternate echo intensities is a measure of the elevation angle of the airplane.

changes in the elevation angle of the airplane. By noting the ranges at which nulls and echo intensity peaks occur during the course of flight, a good estimate of height can be made. In a sense, the airplane, during its flight, scans a fixed radiation pattern. This method has two serious limitations in that echo intensity comparisons must be made for several minutes at least, during which time the airplane is assumed to have constant altitude, and an accurate knowledge of the vertical pattern is required.

A more satisfactory long-wave method uses lobe-switching. By changes in the interconnections of the antenna array two different

vertical lobe patterns are possible. These may be as shown in Fig. 7-13, pattern *A* in solid lines and pattern *B* in dotted lines.

Automatic switching occurs in such a way that the two patterns are used alternately on successive pulses. The echo intensity for pattern *A* is compared with that for *B*, and their ratio is a measure of the elevation angle of the airplane. Additional patterns are available to resolve ambiguities and to give better high-angle coverage of the whole field. The echo-intensity ratio is estimated from an A-scope display (without interrupting the azimuth sweep of the antenna) and height is read from a carefully prepared calibration chart. Under favorable circumstances, good readings require two or three sweeps of the antenna, a time interval of perhaps a minute.

Satisfactory lobe patterns can be obtained only by very careful selection of the site. For example, the ground should be a good conductor, and level to within a few feet in all directions from the antenna for a distance of $\frac{1}{2}$ mile. Calibration patterns are likely to be dependent on azimuth since the ground characteristics as far away as 1 mile have some effect on pattern intensity. Because of this dependence on site and because of poor resolution and low-angle coverage, long-wave height finders are decidedly inferior to the more recent microwave systems.

"Pencil Beam" with Conical Scan.—If a microwave pencil beam is pointed directly at an airplane, the elevation angle required for a height reading is determined by measuring the tilt angle of the antenna. The sharper the beam, the more accurately can its center be recognized and the smaller will be the uncertainty in the angular measurement. The sharp beam gives the required angular precision, however, at the expense of making the target difficult to find.

Precision of setting with a broad pencil beam is achieved by a conical scan as described in Sec. 7-2. This method also depends on a comparison of echo intensities within a beamwidth. Unless the target lies directly on the axis of the radiation cone, the signal is amplitude-modulated at the scan frequency. The modulation is indicated by an error detection meter and the antenna orientation is adjusted until the meter shows zero modulation. Range-gating is required and the height is computed electrically and read on a meter. A conical scan system is well-suited to tracking individual targets but the searchlighting procedure is slow when the heights of several airplanes must be found rapidly.

Vertically Scanned Beams.—Height systems employing a vertical scan are frequently called "beavertails" because of their flapping motion and the shape of their beams. The beams are thinner in elevation than in azimuth, a typical cross section being 1° by 4° . The beam sweeps up and down continuously across a target and the echo is observed on a range-height indicator, RHI, which shows height and range as rectangular

coordinates. The echo extends over perhaps a 1° elevation angle, and height readings are made directly by interpolating to the center of the corresponding pip on the face of the scope.

Beavertails fall into two categories according to whether their azimuth motion is discontinuous or continuous. The discontinuous type is searchlighted in azimuth and is always operated in connection with an associated search set which furnishes azimuth and range information. The azimuth data is used to orient the height-finder mount correctly (by means of a servo); the range then identifies the airplane in question on the indicator.

The continuous type of beavertail rotates in azimuth as it sweeps rapidly in elevation, the rate of advance in azimuth being such as to leave no gaps in the coverage of the whole field. Azimuth and range information from an associated search set are used to select the appropriate sector for presentation on the RHI, although this is not necessary for its operation. A continuous beavertail scanner can furnish data to many RHI's operating independently of each other. If the time for one complete azimuth circuit can be made sufficiently short, this type of system is well-suited for handling a large number of control problems simultaneously.

V-beam.—With this method the functions of plan position search and height-finding are combined into a single system. Two radiation sheets are employed. These are thin in the azimuth direction and sufficiently broad in elevation to give the desired vertical coverage. One sheet is vertical; the other is tilted at an angle of 45° to the vertical. The antennas for the two sheets are mounted on a single platform that rotates continuously in azimuth. The direction of rotation is such that the vertical sheet always leads the slant sheet. In each revolution a target is intercepted, first by the vertical beam, and then by the slant beam. The angle through which the mount turns between the two interceptions is a measure of the elevation angle of the target. It is clear that the motion of the slant sheet in azimuth also results in a simultaneous sweep in elevation. Angles of elevation are thus turned into apparent azimuth delay angles. The vertical beam alone is used for plan position information.

If the antennas for the vertical and slant sheets are oriented on the mount so that the two sheets intersect in a horizontal plane, the two beams form the edges of a large tipped "V" or trough, the leading edge being vertical and the trailing edge at 45° with respect to it. In this case the sine of the azimuth-delay angle is equal to the tangent of the elevation angle, and the two angles are very nearly equal. A difficulty with this arrangement is that the finite azimuth thickness of the beams causes them to overlap near the horizon with the result that the slant

and vertical echoes from a low elevation angle target are not resolved. This difficulty is avoided by offsetting the slant antenna by a fixed lag angle 10° in azimuth behind the vertical. The ground edges of the two beams are then separated by 10° and all delay angles increased by this amount. This design also makes it possible to divide the height-indicator screen into two regions, one restricted to vertical signals and the other to slant signals. The fixed delay must be kept small since it increases the percentage accuracy requirements of the angular measurement.

The height indicator is a modified B-scope with range plotted horizontally and azimuth vertically. The lower portion of the indicator screen receives vertical beam signals over a particular 10° azimuth sector chosen by the height operator. The remaining upper portion of the presentation receives echoes from the slant beam. Each echo in the lower portion has a companion slant echo in the upper portion at the same range. A movable external scale is used to measure the azimuth separation of the echoes and gives readings directly in height. Many height indicators can be operated independently of each other from the same system and, like the continuous beavertail, the V-beam method is particularly suited to handling many control problems simultaneously.

7-4. General Problems of Design. *Absolute and Relative Height Accuracy.*—It is desirable to distinguish between the accuracy of the measurements of difference of the height between two airplanes and the accuracy of the absolute value of the height obtainable for a single airplane. If the two airplanes are widely separated in bearing, range, and height, the accuracy in the difference in height may be little better than the absolute accuracy. As the separation of the two airplanes decreases, the accuracy of the difference tends to improve. A specification of relative height accuracy implies that the two airplanes are within a few thousand feet of each other in height and sufficiently close in azimuth and range to be seen simultaneously with the same indicator setting.

Accurate readings of absolute height require correct adjustment of the expansions of the indicator sweep and careful determination of the zero altitude position whereas height differences are not so dependent on calibration. For example, if the vertical axis of a beavertail mount is actually not quite vertical, all elevation angles may appear to be too large at one azimuth and too small in the opposite azimuth by perhaps 0.5° . This error does not affect relative height measurements for airplanes at the same azimuth. Or again, if the indicator expansions on an RHI are incorrect by 10 per cent, measurements on two airplanes at 10,000 ft and 12,000 ft, respectively, will have absolute height errors of about 1000 ft but a relative height error of 200 ft.

In regions of anomalous propagation the measured absolute heights

are likely to be too high, although the effect is important only for airplanes that have true elevation angles less than about 1.0° . Relative heights are affected less, provided that the airplanes are close together.

Absolute height readings with respect to sea level represent values that are like barometric altimeter readings made in the airplane in that they do not represent height above the surface of the ground directly below the airplane. Such information, however, is an important requisite in regions where the topography is varied.

Effect of Elevation Beamwidth on Accuracy.—If an airplane is within an elevation beamwidth of the horizon it can receive simultaneously energy that has traveled by two different paths: energy from the upper part of the beam comes directly from the antenna while energy from the lower part of the beam reaches the target after reflection from the ground at grazing incidence. The result is much the same as if the airplane were accompanied by a companion image airplane an equal distance below the horizon and the ground were not present. Because of interference between the two paths, the signal intensity may be either stronger or weaker than normal. The effect is much more pronounced over water than over poorly reflecting dry ground or broken surfaces. As explained in the previous section, long-wave systems use this intensity variation for their height-finding information. With microwave height finders the surface reflection, if important, fixes a lower limit to the size of elevation angles that can be measured reliably.

Because the variations of intensity resulting from interference disturb the correct setting of the antenna on the target with a conically scanned pencil beam, erratic height readings are obtained (over water) if the target elevation angle is less than about 0.7 of the beamwidth in elevation. With beavertail and V-beam systems the companion image airplane produces a signal below the horizon on the height indicator. If the target echo and the image echo are not resolved on the indicator it is difficult to determine the center of the true echo.

Tests made over water with a continuous beavertail height finder show that satisfactory readings are possible if the target is not closer to the horizon than 0.6 of an elevation beamwidth. The V-beam should give similar results, except that in this case the satisfactory minimum target elevation should be 0.6 of the azimuth beamwidth of the slant sheet.

Besides this minimal height effect, the elevation beamwidth causes an uncertainty of interpolation in all height readings. The error-detecting device of conical scan allows accuracy of the elevation angle up to about $\frac{1}{10}$ of a beamwidth. For beavertails, a good operator can select the center of the signal on an RHI screen to 0.1 beamwidth or better. With V-beam, the uncertainty is greater than this because the separation between two echoes must be measured on the screen.

While the beamwidth spoken of here refers to the two-way half-power width which is a function only of the wavelength and antenna size, the actual echo length of the spot on the screen of an indicator depends also on the signal intensity, that is, on the range and size of the target. Frequently, the best height readings are obtained when the signal is relatively weak and the echo correspondingly small. It is important that the antenna be designed to reduce elevation side lobes to a minimum.

Pulse Spacing Effect.—Target information is not obtained continuously, but at the pulse repetition frequency, PRF; a beam which is scanning may move appreciably between pulses and produce a corresponding uncertainty in the measured data. For instance, suppose that a beavertail beam requires the time of an integral number of pulses to sweep across a target. As the beam sweeps upward, a pulse may occur either just before or at the moment that the upper edge of the beam reaches the target. The difference in height reading between these two possibilities is the vertical distance (at the target range) that the beam moves between pulses. A fair measure of the uncertainty in elevation angle due to this effect is one-half the angular displacement of the beam between pulses for continuous beavertail systems and, on a probability basis, somewhat less than twice this amount for V-beam systems. The uncertainty with discontinuous beavertails can be reduced by multiple vertical scans.

Scanning Losses and Speeds.—To compare the effect of scanning on the range capabilities of different beavertail and V-beam systems, it is convenient to write the scanning-loss ratio discussed in Sec. 1-3 in the following form:

$$\text{Scan loss factor} = \left(\frac{\text{solid angle over which energy is spread in 8 sec}}{\text{beam cross section}} \right)^{1/2}$$

This represents the loss on a power basis, while the factor by which range is reduced is obtained by changing the exponent from $\frac{1}{2}$ to $\frac{1}{4}$. Both the solid angle of scan and the cross section of the beam are to be measured in the same units, square degrees, for example, and their ratio indicates how thin the energy pulses are spaced. In calculating the ratio for discontinuous beavertails, the azimuth beamwidth appears as a factor in both numerator and denominator, thus canceling out; and similarly, the vertical beamwidth cancels from the ratio for a V-beam. Clearly the scanning loss becomes a particularly important consideration in the design of continuous beavertails, since the numerator involves motion in both azimuth and elevation.

The traffic capacity of discontinuous beavertails is limited by operator time (for azimuth servo adjustment and height reading), azimuth slewing

time, and elevation sweep time. If slewing is done at the rate of 40° to 60° per sec, and the elevation sweep at 1 or 2 oscillations per second, the chief limitation is probably operator time. Decreasing the speed of the elevation sweep increases the difficulty both of finding the target and of keeping the mount at the proper bearing during observations.

If a V-beam system is operated with a slow azimuthal speed, measured heights must be corrected for changes caused by tangential motion of the

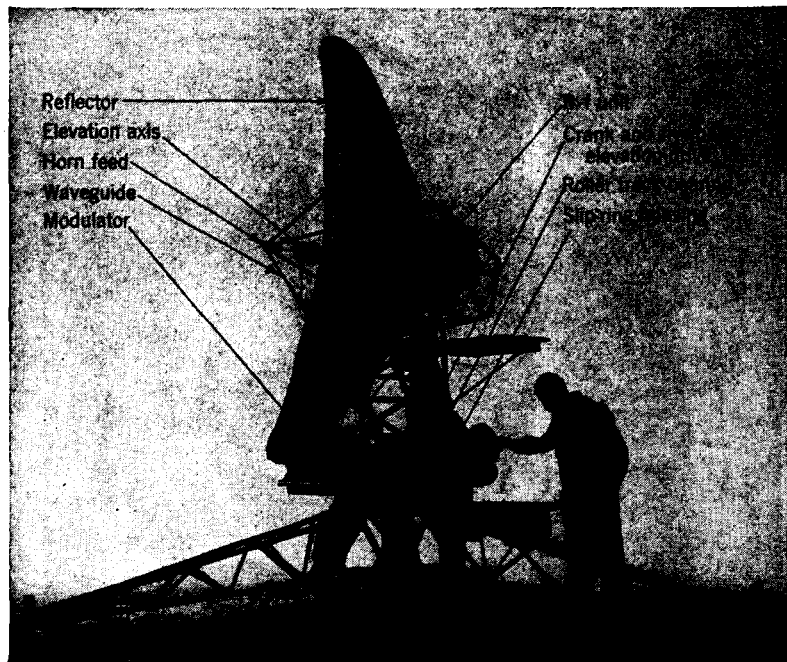

FIG. 7-14.—The AN/TPS-10 mount. This is a 3-cm beavertail height finder designed for portability and high resolution.

target. The correction is equal to the tangential distance in feet that the airplane moves between interceptions with the two beam sheets. This distance is usually sufficiently small to be neglected for a rotation rate of 6 rpm, a 45° tilt angle, and a fixed delay angle of 10° .

Many methods are available for producing the elevation scan for beavertail systems. Although these are discussed in detail in *Radar Scanners and Radomes*, Vol. 26, Chap. 7, Radiation Laboratory Series, a few of the principal methods should be mentioned here. They may be characterized as slow, medium, and fast according to their inherent speed limitations.

The simplest and slowest scan arrangement consists of a paraboloid and horn feed "wobbled" as a unit through the required scan angle. With a large paraboloid it may prove mechanically difficult to achieve a scan rate as rapid as 1 cps. The amplitude of the required mechanical

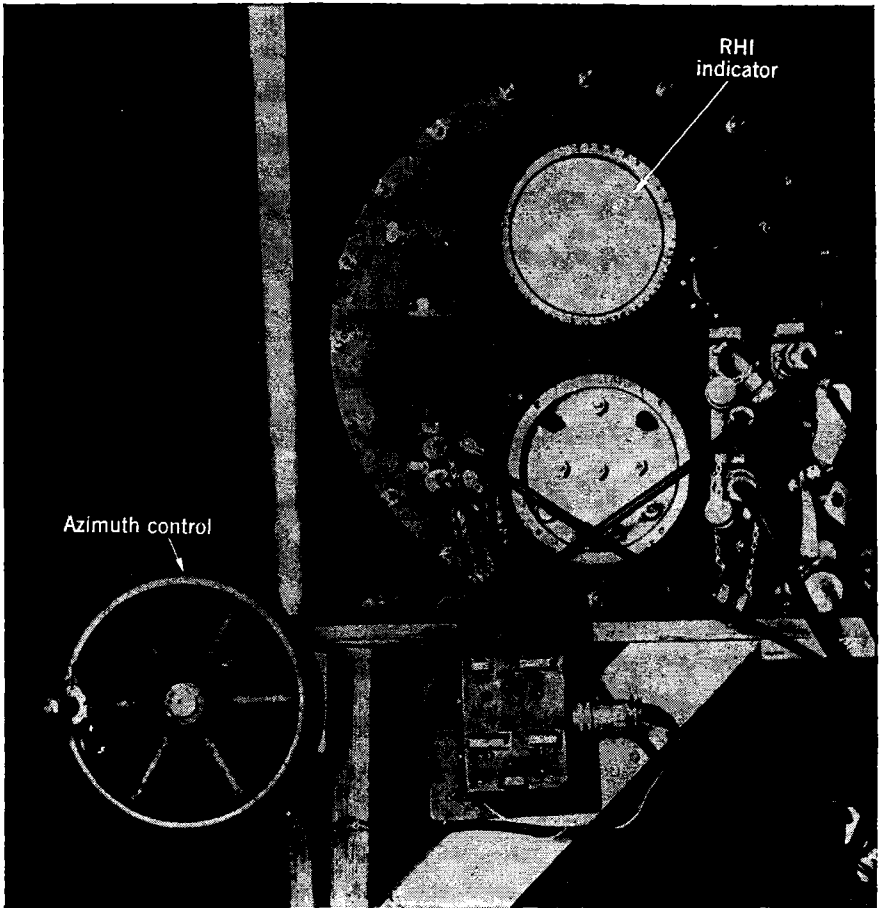

FIG. 7-15.—The AN/TPS-10 range-height indicator. Elevation is presented vertically and range horizontally. The knob to the right of the cathode-ray tube controls the position of a mechanical height line, and at the same time turns a calibrated dial around the edge of the scope screen. After adjusting the line to cover the center of the target echo, height is read directly from the dial. The handwheel shown at the left controls the azimuth position of the mount. (Courtesy of United States Army.)

motion is reduced by a factor of 2 if the horn feed is fixed and the paraboloid alone is wobbled. A difficulty with this latter arrangement is that the beamwidth broadens when the feed is more than 4° or so from the focal point. Since one of the extreme positions of the swing is approximately

along the horizon, the greatest broadening of the beam occurs just where it is most desirable to keep the beamwidth narrow.

If a fixed cylindrical paraboloid is illuminated by a linear dipole array, the direction of the beam can be changed merely by changing the width of the waveguide that feeds the dipoles. Changing the width of the guide changes the wavelength of radiation inside the guide; this

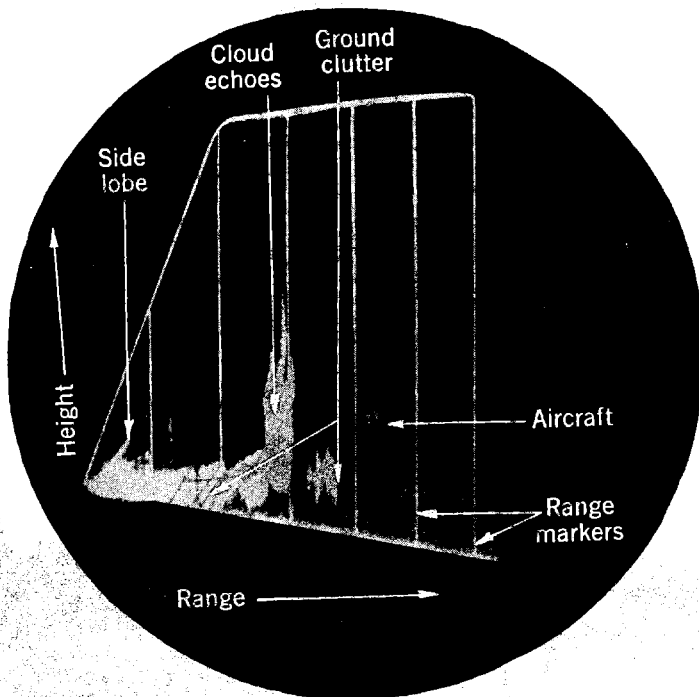

Fig. 7-16.—An AN/TPS-10 presentation. This shows the appearance of typical signals. The ground clutter is about 2° above the lower limit of the sweep. The two targets shown between the 40- and 50-mile range markers are 5000 ft high and about 1 mile apart. (Courtesy of United States Army.)

in turn changes the relative phase of the energy radiated from each dipole. The effect is to vary the direction of the radiated wavefront and thus of the beam. The method works well at 3-cm wavelengths but the mechanical arrangements of the waveguide become bulky at 10 cm. This technique is further described in Sec. 7-8.

One example of a fast scan suitable for continuous beavertails is the Robinson method. The speed is due to the fact that the only mechanical motion involved is one of rotation. The method, in effect, moves a horn source rapidly up and down in front of a paraboloid reflector. Actually,

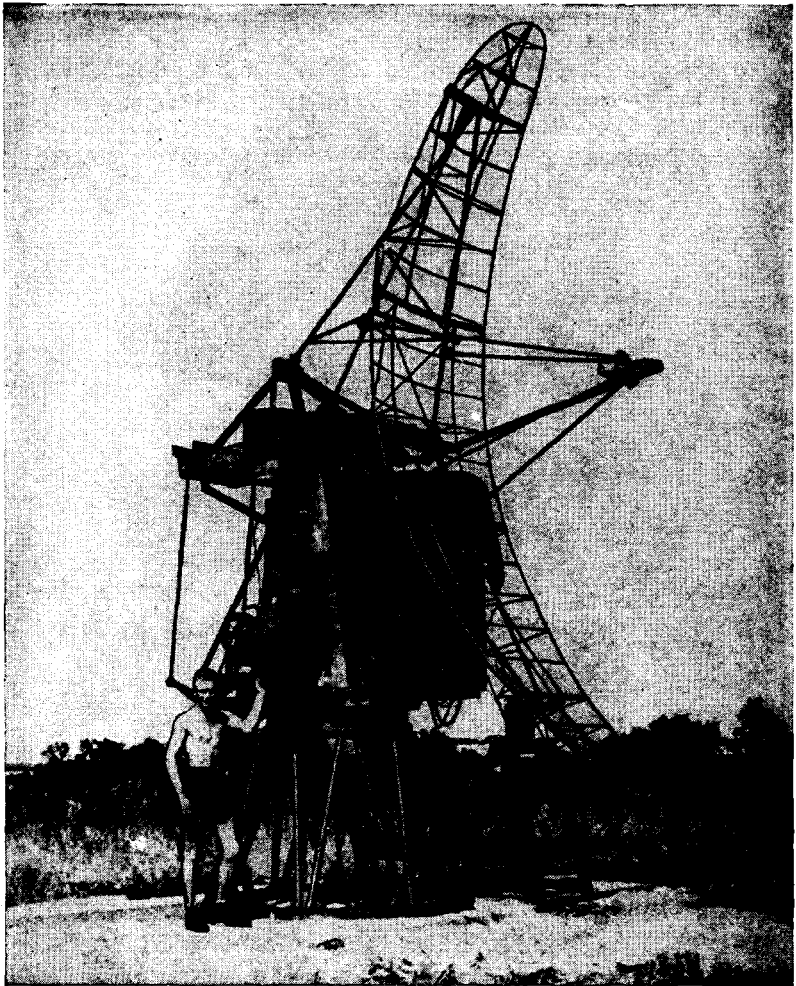

FIG. 7-17.—Antenna mount of a 10-cm beavertail long-range height finder. The difference in size between a 3- and 10-cm antenna can be appreciated by comparing this picture with Fig. 7-14.

the horn rotates inside a specially shaped cylindrical throat which, in turn, feeds the paraboloid. The beam moves downward during 80 per cent of the scan cycle and the upward motion is blanked.

7-5. Illustrations of Some Recent Systems.—The photographs of this section show characteristic features of four recent microwave height finders. These comprise two discontinuous beavertails, AN/TPS-10 at 3 cm (Figs. 7-14, 7-15, and 7-16) and a similar set at 10 cm (Figs. 7-17,

7-18, and 7-19); a shipborne continuous beavertail (Figs. 7-20, 7-21, and 7-22); and a V-beam set at 10 cm (Figs. 7-23, 7-24, and 7-25).

The antenna systems in Figs. 7-20 and 7-23 provide complete search data in addition to their height-finding function and consequently are considerably more elaborate than the simple beavertails. Since AN/TPS-10 is probably the most likely of the four sets to serve as a model for a future aircraft-control height finder, a brief consideration of its design constants may be of interest.

AN/TPS-10 was actually planned with two uses in mind; first, as a medium-range height finder for use with a companion search system and

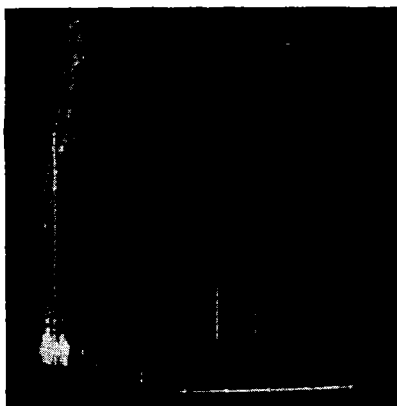
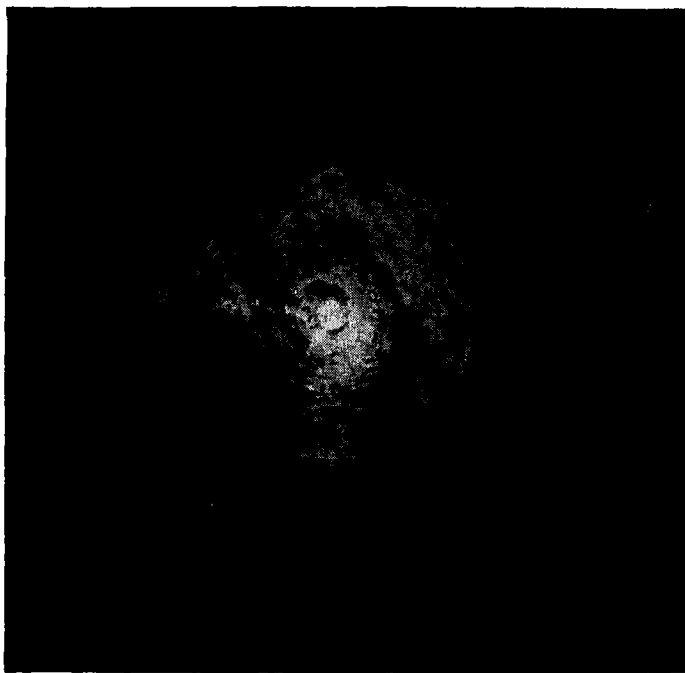

FIG. 7-18.—RHI presentation. The vertical lines are range marks at 10-mile intervals. Height is read directly from an overlay, constant height lines at 1000-ft intervals appearing as dark horizontal lines slightly curved to allow for the curvature of the earth. The faint lines slanting outward from the origin indicate the direction of individual sweep traces. Airplanes are shown at 6500 ft, 5200 ft, and 10,500 ft; at 47, 57, and 59 miles.

second, as a general-purpose ground radar for use in mountainous regions where ground clutter makes operation of an ordinary cosecant-squared search beam of doubtful value. Since these purposes require a high-resolution beam and easy portability, a 3-cm set is necessary.

A picture of the AN/TPS-10 mount is shown in Fig. 7-14. The antenna consists of an elliptical section of a paraboloid, 10 ft high by 3 ft wide (an area of 24 ft²), which is fed by a waveguide horn placed at the focus. The resulting beam has half-power widths of 0.7° in elevation and 2.2° in azimuth, with an antenna gain factor of 17,000. A motor-driven crank produces the elevation sweep by rotating the reflector and horn together as a unit about a horizontal axis. The beam sweeps from 2° below to 23° above the horizon and back in 1 sec. When operating with a separate search system the beam is oriented in azimuth toward particular targets by means of a handwheel in the indicator shack and a



(a)

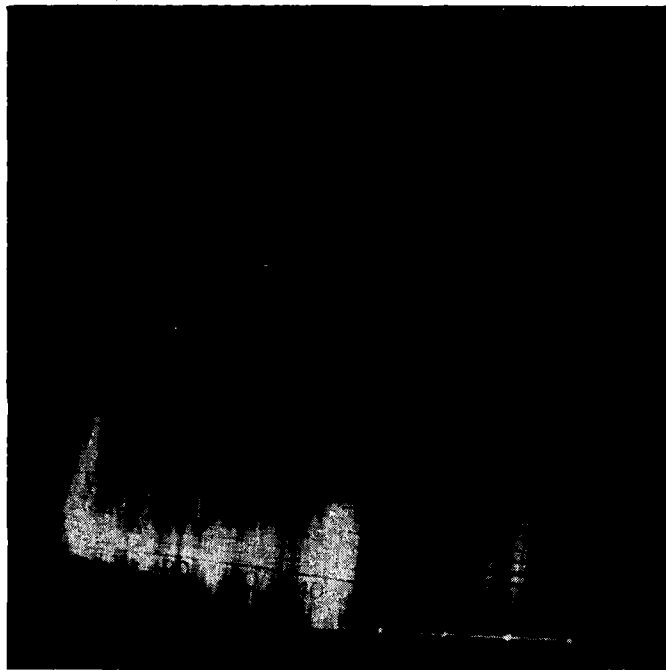

(b)

FIG. 7-19.—Effects of anomalous propagation: (a) shows the PPI screen of a cosecant-squared search beam during severe anomalous propagation. The extensive ground clutter (out to 50 miles) results from trapping and makes the search system almost useless on such occasions; (b) was taken at the same time and shows the RHI screen with the mount rotation at 300° . An airplane is shown flying above an anomalous signal at 5000 ft and 21 miles. This illustrates the value of a vertical presentation.

mechanical linkage to the mount. If the set must perform its own search functions, on the other hand, it can scan as a slow continuous beavertail over selected azimuth sectors. This is accomplished by a scan motor that advances the mount in azimuth by 2° for each vertical oscillation, or at the rate of $\frac{1}{3}$ rpm.

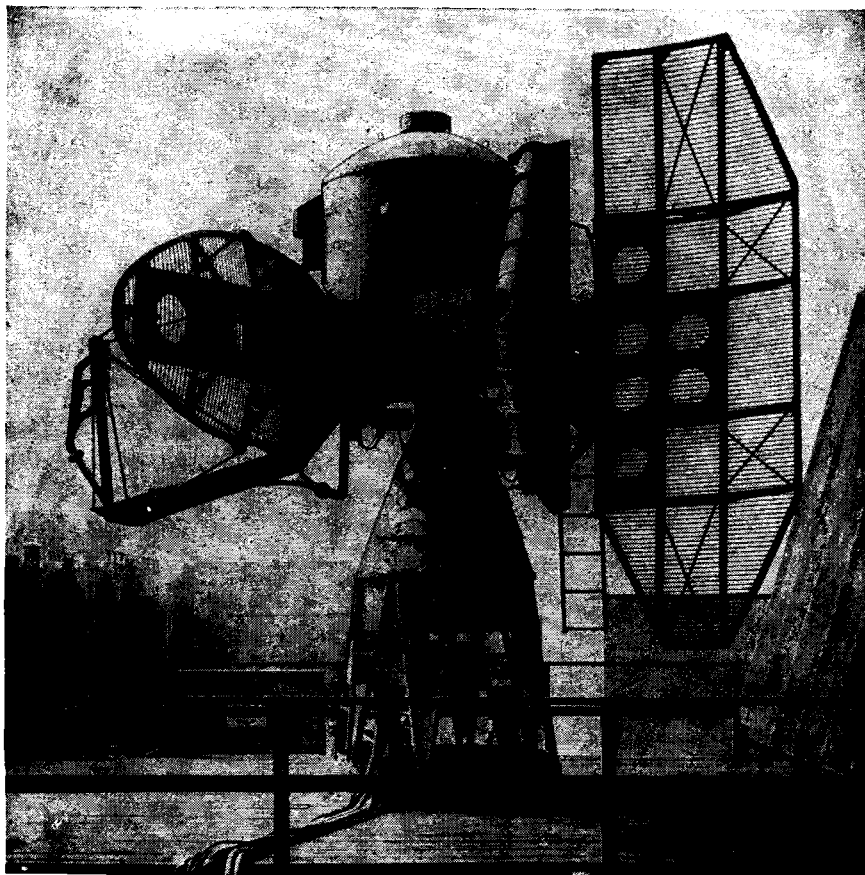

FIG. 7-20.—An experimental arrangement showing the search and height-finding antennas on a single mount. The search antenna is shown at the left and the height finder at the right. They rotate continuously in azimuth at 4 rpm.

The transmitter has a pulse power output of 60 kw, a pulse length of 1μ sec and a repetition rate of 1000 pulses per second. The receiver has a 2-Mc/sec pass band and an over-all noise power about 15 db above the theoretical minimum value. These two components are mounted together in a box placed just behind the center of the reflector; a single rotating r-f joint is used to allow for the vertical oscillation. Figure

7-15 shows the range-height indicator while Fig. 7-16 shows a typical appearance of the indicator face.

Suppose now we calculate some of the performance characteristics that can be expected. If the beam is swept up and down continuously across a target without change in azimuth, the solid angle of scan is $2.2^\circ \times 25^\circ$, which when divided by the beam cross section ($2.2^\circ \times 0.7^\circ$) gives a scanning loss factor of 6 in power. A receiver pass band of 2 Mc/sec and noise level of 15 db corresponds to a noise power of 2.6×10^{-13} watt. If we make use of Eq. (3) in Sec. 1-3, we can calculate the minimum observable signal

$$S_{\min} = \frac{90}{(1000)^{3/2}} \times 6 \times 2.6 \times 10^{-13} \quad (3)$$

$$= 44 \times 10^{-13} \quad \text{watt.}$$

This enables us to calculate the expected range from Eq. (2) in Sec. 1-3. Setting $P_t = 6 \times 10^4$ watts, $A = 24 \text{ ft}^2$, $\lambda = 0.105$ ft, and assuming a target for which $\sigma = 800 \text{ ft}^2$, we find that

$$R_{\max} = 70 \quad \text{miles.} \quad (4)$$

Actually the ranges reported with early models of the set are about 60 miles, a reasonable agreement as radar calculations go.

If the beam is scanning in azimuth at 2° per sec as well as sweeping up and down, the scanning loss (in power) becomes

$$\left(\frac{16^\circ \times 25^\circ}{2.2^\circ \times 0.7^\circ} \right)^{3/2} = 16 \quad (5)$$

instead of 6, corresponding to a further reduction in range by 28 per cent. While 2° per sec or $\frac{1}{3}$ rpm is much too slow a scan rate

for 360° search coverage, it is useful for covering small azimuth sectors. Thus, AN/TPS-10 could be used to survey the air traffic coming over a narrow mountainous pass where almost any other type of radar would be unsuitable. If the set were to be used as a continuous beavertail for all-round search or control, either the elevation scan rate would have to be much more rapid or else the azimuth beamwidth considerably increased



FIG. 7-21.—Robinson scanner. This is a view of the specially shaped throat of the Robinson scanner, which is used to illuminate the reflector of a height finder. It can be seen mounted in front of the reflector at the right in Fig. 7-20. A rotating waveguide feed is attached to the coupling shown in the center. (Courtesy of American Machine and Foundry Company.)

to allow more rapid azimuth rotation. Either change involves a loss in range.

The unusually narrow beamwidth in elevation of 0.7° allows excellent resolution in height. An airplane echo is separated from ground clutter if it is a beamwidth above the horizon while airplanes can be recognized

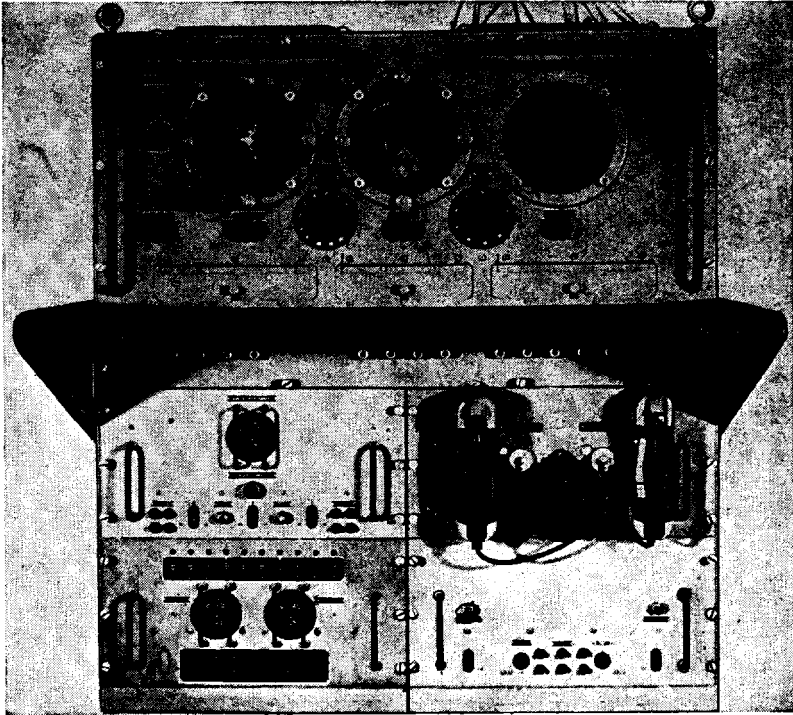

FIG. 7-22.—An indicator which presents both search and height data. The PPI at the left presents signals from the search antenna. Expanded off-center PPI sectors can be displayed in the center, and the height indicator (RHI) at the right can be adjusted to display signals continuously or only for the particular azimuth sector selected by the operator. An airplane at 31 miles and 10,000 ft is about to pass above the clouds at 38 miles.

as such and heights determined for flights even lower than this. Assuming an indicator interpolation uncertainty of one tenth of a beamwidth we can expect measurements of elevation to have a relative accuracy of $\pm 0.07^\circ$ or ± 300 ft at 50 miles. The pulse spacing is $\frac{1}{10}^\circ$, assuming a constant scan speed; since the scan is actually sinusoidal the spacing is considerably closer than this near the horizon and should not enter as an uncertainty in the height data if time enough is allowed for several sweeps. Field tests show that an elevation angle resolution of $\frac{1}{10}^\circ$ (slightly better

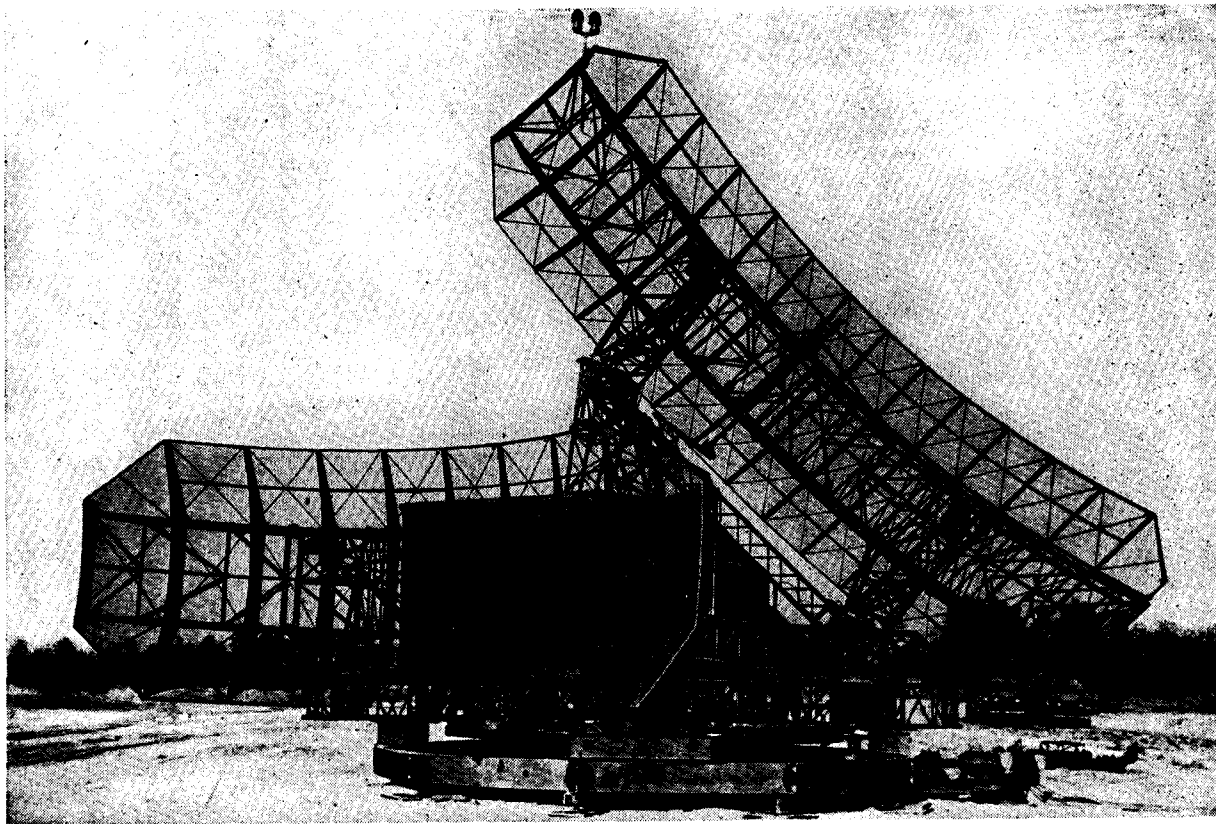
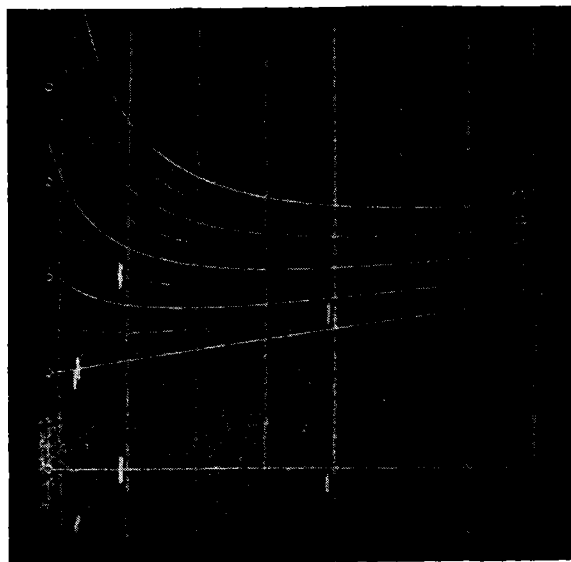
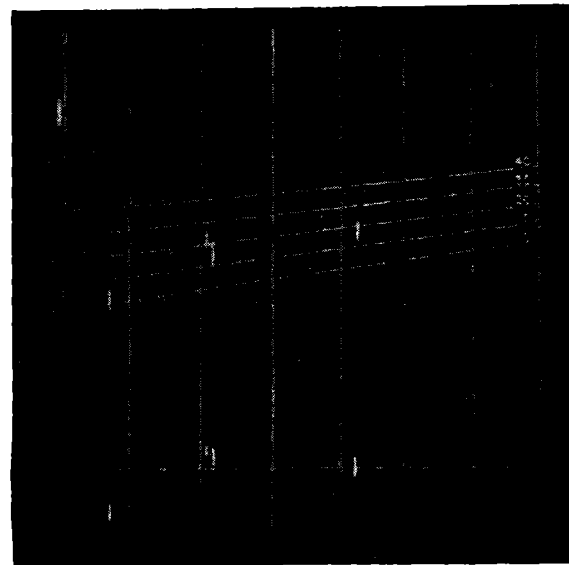

FIG. 7-23.—The V-beam mount. This picture shows the relation between the vertical and slant-beam antennas. The platform turns in azimuth at 6 rpm and the vertical coverage is 25° . This is a 10-cm system.



(a)



(b)

FIG. 7-24.—V-beam height indicator presentation: (a) 10- to 80-mile scale. The vertical lines are range marks at 10-mile intervals. Airplanes are shown at 12, $12\frac{1}{2}$, 19, and 49 miles at heights of 6000, 7000, 15,000, and 10,000 ft, respectively. The height scale can be moved up and down and is shown adjusted to read the height of the airplane at 19 miles. The demarcation between vertical- and slant-beam signals is clearly indicated by the thin dark line across the screen; (b) 70- to 140-mile scale. Airplanes are shown at 77, 91, 92, and 112 miles at heights of 19,000, 15,000, 10,000, and 17,000 ft, respectively.

than the 0.07° above) can be recognized provided that the two airplanes involved are resolved in range. It is reported that 70 per cent of field height readings have an absolute height error of less than 1000 ft with a maximum error of about 2000 ft.

A 3-cm beavertail designed for air traffic-control purposes today could give markedly better performance than AN/TPS-10. Pulse powers of 200 kw rather than 60 kw are now available and a 10-db receiver noise level is reasonable. These would give an increase in the range factor of

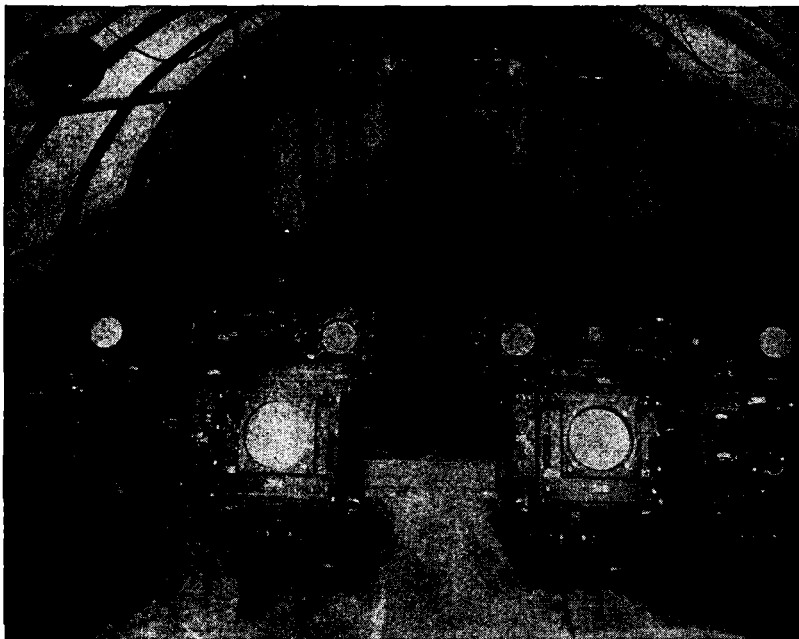

FIG. 7-25.—Control room. Six PPI's and four height indicators (with viewing hoods) are shown. Aircraft are controlled directly from the PPI's; the course of flights and other data can be marked on the vertical plotting board in the background.

1.8 or a total range of about 125 miles for a large airplane. With this increased range, however, the repetition frequency would have to be reduced to perhaps 650, equivalent to a range reduction of 6 per cent. A permanent installation would use a 12-in. cathode-ray tube for the RHI and the angular data take-off from the mount and the accuracy of calibration could be considerably improved.

The azimuth orientation of the mount should be controlled by a servomechanism and the height-finder orientation accurately indicated by a radial cursor on the associated PPI of the search set. This last arrangement is very necessary since it is operationally difficult to keep

the 2° beam of AN/TPS-10 properly oriented for airplanes that are moving rapidly in azimuth.

RADAR AIDS FOR LANDING

By G. C. COMSTOCK

During the past five years radar principles have been applied to ground-based landing aids. Since these aids have been developed almost exclusively for the Armed Forces, the equipment was designed for military operations. We shall discard the embellishments that are purely for military use and concentrate on the features that have universal applications.

These radar landing aids can be divided into three general classes:

- (1) Beam approach equipment.
- (2) Beacon approach equipment.
- (3) Ground-scanning radars utilizing ground control of approach or GCA techniques.

7.6. Beam Approach Systems.—The pulsed technique was first applied to the development of microwave straight-line glide-path and localizer systems presenting equisignal paths in elevation and azimuth and with pilot presentation on cross-pointer meters or similar indicators. Similar systems, using c-w techniques, were being developed at lower frequencies.

Before the war, microwaves were considered extremely promising for overcoming a number of the fundamental difficulties encountered in similar systems at longer wavelengths. These included the problems arising from the reflections of the radio waves from the ground and obstacles which gave erroneous directional information in both localizers and glide paths, and the problem of producing adequately narrow beams with reasonably sized antenna structures.

A complete c-w microwave localizer and glide-path system has been under development in this country for the past four years. Pulsed microwave development was begun simultaneously although only the glide path was thoroughly developed. During the early development of conical-scanning gun-laying systems a preliminary investigation was made of the production of a conical beam, such as a glide path, down which an airplane should fly.

The conical beam was generated by rotating a 10-cm transmitting dipole through a small circle about the focus of a parabolic reflector. The conical beam was divided into four 90° quadrants, each having a different repetition frequency. This was done by commutating the transmitters mechanically to get PRF's of 2000 and 2400 cps for upper

and lower vertical quadrants, and 1800 and 2200 cps for the two horizontal quadrants. The receiving equipment in the airplane consisted of a simple bolometer and amplifier feeding into four audio filters, each tuned to the frequency of one quadrant. The output of these filters then was proportional to the intensity of the lobe at the receiving antenna in the airplane. Outputs of corresponding pairs such as the two vertical ones were fed to a cross-pointer meter or to the plates of a cathode-ray tube. Figure 7-26 shows a block diagram of this early experimental system. The idea, of course was to use the indicator as a null instrument to locate the position of equal signal intensity.

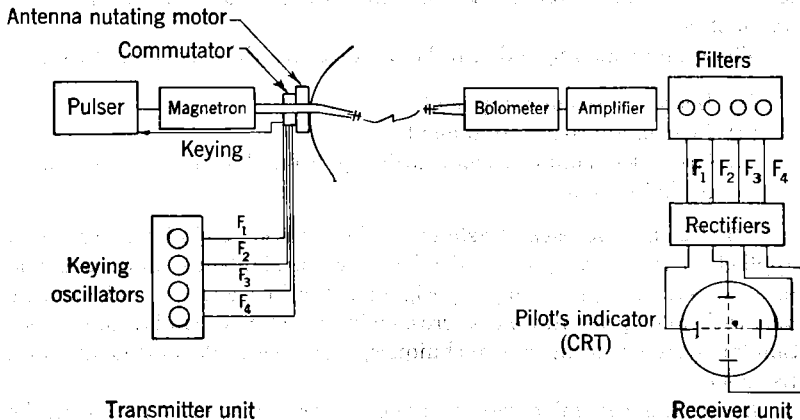

FIG. 7-26.—Block diagram of an early experimental bolometer blind-landing system.

This early system, despite its inadequate range and too narrow azimuth beam, led to the complete development of what became known as the pulsed glide path, PGP. A discussion of PGP will illustrate the problems inherent in designing systems of this type.

Specification of Pulsed Guide Path, PGP.—Among the general provisions to be met in the design of a pulsed glide path were the following:

1. Lightweight ground-transmitting equipment, easily portable at an airport, and air transportable.
2. Minimum weight and bulk of airborne equipment—receiver to weigh 10 lb or less.
3. A reliable range of at least 10 miles.
4. Glide path provided at angles from 2° to 3° .
5. A vertical antenna pattern sufficiently narrow to eliminate almost all ground reflection from flat terrain. A horizontal pattern sufficiently wide to allow for setting the transmitter several hundred feet from the runway. This required that antenna patterns have very weak side lobes in all directions.

The production version of the pulsed glide path was a 3-cm straight-line equisignal glide path produced by sending out a dual lobe, each lobe pulsed at a different repetition frequency as indicated in Fig. 7-27. The upper beam was pulsed at 2200 cps and the lower at 1800 cps. The dual lobes were formed by feeding the RF alternately to two pill-box antennas. Each antenna consisted of a thin parabolic cylinder with a 4-ft opening, a

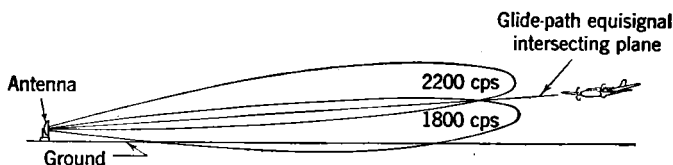

FIG. 7-27.—Dual-lobe glide path.

width less than $\lambda/2$, and depth greater than its focal length. This gave a vertical beamwidth of about 2° with side lobes less than 0.5 per cent. The cylinder was flared along its 4-ft length to give a desired horizontal half-width of about 30° . The feed was a slotted waveguide.

The antennas were so placed that their horizontal patterns were coincident, but with an angle of approximately 2.25° between the vertical beams, giving a crossover of about 60 per cent (see Fig. 7-28).

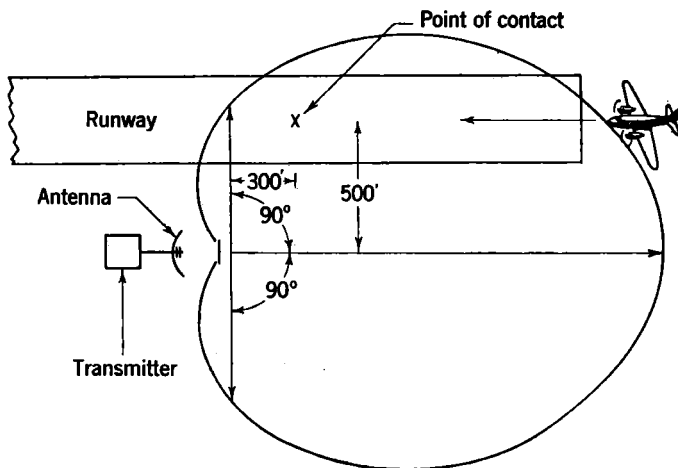

FIG. 7-28.—Horizontal beam pattern of dual glide path.

The transmitter was of conventional design with a magnetron of 15-kw pulse power, which could be replaced by a magnetron capable of a pulse power of 50 to 100 kw to obtain the desired range more consistently. An r-f switch in the form of a slotted disk rotating between two waveguide chokes alternated the power to the antennas. At the same time the pulse frequency of the modulator was altered synchronously with the

power switching so that each lobe had its identifying pulse modulation. The entire transmitter, including antennas, when mounted in a case weighed about 375 lb and could be transported by air. The system was built for operation on 400-cycle power.

The airborne receiving antenna system was extremely simple. A small horn in a streamlined lucite housing fed a crystal matched into a short piece of waveguide. The rectified output was fed to a simple

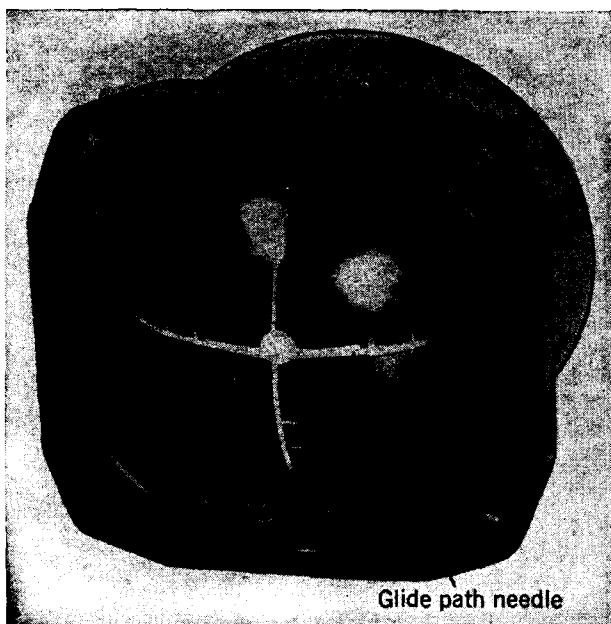

FIG. 7-29.—Cross-pointer meter for pulse glide path. (Courtesy of Sperry Gyroscope Company.)

three-tube audio amplifier using parallel-T filter networks, each designed to pass the pulsed modulation of one of the beams.

The pilot indicator was a cross-pointer meter, shown in Fig. 7-29. The output of the amplifier was applied to the horizontal needle so that a downward deflection was shown when the aircraft was in the upper beam, and an upward deflection when in the lower beam. A small airplane was painted in the center of the face of the meter and the pilot flew the airplane on the meter up and down with respect to the needle to get an on-course indication.

To achieve a reduction in angular sensitivity of the indicating system as the airplane approaches the transmitter, the receiver uses an AVC that produces a drooping output characteristic for increasing input. It has

been found necessary to use such a softening of the course indication when flying cross-pointer indication to prevent excessive "hunting" by the pilot.

Evaluation of Pulsed Beams.—The PGP system as tested at a number of different airports has the following advantages:

1. Over flat terrain, the glide paths were straight and flyable with steady needle action that indicated no bends (due to reflections) for glide paths down to 2° . Because the narrow 2° beam with low side lobes allows little energy to strike the ground near the airport, the glide path is essentially independent of local ground conditions of moisture, etc.
2. Over obstructions such as hangars, etc., there were considerably fewer bumps in the path due to reflections than encountered with lower frequency c-w systems.
3. A reliable range of 15 miles is attainable with recent standard transmitting and receiving techniques.
4. Size and bulk of ground equipment has been reduced to a minimum, offers little hazard to flight, and can be transported from runway to runway.
5. Airborne equipment is simple and reliable.

The limitations are, in general, the same as those of the c-w beam systems, namely:

1. Dependence on beam intensity for information, particularly on the constant crossover of dual beams, is a weakness that can be alleviated partially by constant ground monitoring of beam position and by some simple and, if possible, automatic means of correcting "squinting" errors. No monitoring equipment was designed for PGP. Such a step is not inconceivable, however, although it is difficult to monitor an elevated beam without creating a ground hazard. The type of antennas, feed, and power switching used in microwave equipment reduces the likelihood of such beam swinging but does not entirely eliminate it. Monitoring for localizers would present fewer complications.
2. Siting problems due to reflections from obstacles, are reduced.
3. The equipment gives the pilot no information on the position of obstacles. The safety of the pilot depends only on whether a clear airport site has been selected. If a poor approach is made he is in little danger azimuthally and can make a pull-out at a safe altitude as indicated by his altimeter and his knowledge of the terrain. Unfortunately only a few airport runways at which it would be desirable to make instrument approaches under all-weather flying

- conditions are as safe as this and then usually in but a single runway direction per airport.
4. The equipment gives no warning of the presence of other aircraft on the glide path.
 5. No information as to range or rate of approach is available to the pilot. Thus, one of the real advantages of pulsed techniques has gone unused.
 6. There is considerable danger of interference between ground stations and of audio jamming of the receiving and indicating equipment by other radars unless some form of audio channeling is provided.
 7. The presentation of relative position only on a cross-pointer meter requires that the pilot have considerable skill and practice in interpretation and coordination to obtain the necessary heading and rate of descent for a successful low approach, particularly under cross-wind conditions.
 8. The equipment is purely a pilotage device; it supplies no information to the ground for controlling traffic into or on the final approach zone.

The fundamental advantages discussed above seem to be primarily those of microwaves and do not show any clear advantage of pulsed techniques over c-w methods in producing pure beam-type glide paths and localizers as long as stable transmitters and lightweight reliable receivers are available for both types.

The limitations listed above show that pure beam approach systems are rudimentary. In the discussions that follow, the real advantages of radar technique in overcoming some of these limitations are seen.

7-7. Beacon Approach Systems, BABS.—BABS or Radar BA Type is a radar aid to approach, designed to provide single or multilobed localizer and glide paths. Airborne indications showing the position of the airplane with respect to these paths includes continuous indication of the range from ground-based beacons. The interrogator-responder is carried in the aircraft and the indicator may be either a double A-scope (L-scope) or a meter. This system grew out of the need in the early part of the war for systems using available airborne radar gear to replace the inadequate radar aids to approach.

The pilot is "talked down" by the navigator who gives him the necessary information about heading and range. This talk-down procedure is not inherent in the system; the information can be presented to the pilot and copilot directly. Many pilots, however, prefer to have the information assimilated by some one else so that they can give more attention to their other flight instruments.

In spite of the advantages that would result from the use of microwaves, all development of BABS equipment has been at frequencies below the microwave band, generally near 200 megacycles. The three necessary components of a BABS system are an airborne interrogator-responder, indicating equipment, and a ground beacon.

Interrogation.—Airborne radar systems such as the early aircraft interception, AI, and aircraft-to-surface-vessel, ASV, equipment, and interrogator-responders similar to those used for IFF were used in BABS in its early forms.

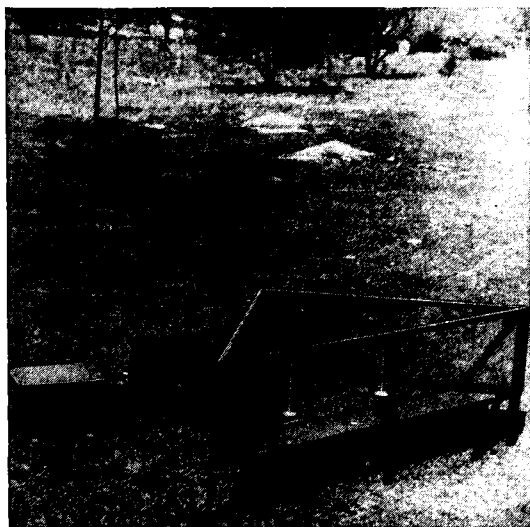

FIG. 7-30.—A 200-Mc beacon for beam approach. (Courtesy of United States Army.)

The interrogator of the newest British version can be set at any one of 12 frequencies, and the ground beacon at each particular location is assigned one of these frequencies. Thus, a number of airfields in close proximity can be equipped with approach systems which are readily identified and which do not interfere with one another.

A cross-band airborne interrogator-responder recently developed consists of an *L*-band (about 25 cm) transmitter operating on a number of preselected frequency channels and a 10-cm receiver tunable to any one of a number of 10-cm reply channels.

Ground Responder Beacons.—Early development in England and in this country was concerned primarily with split-beam localizers. Glide paths have been devised only recently.

The first BABS equipment was a lashed-up dual-beam localizer produced by lobe-switching the output of an IFF transponder by connecting

it in turn to two different antennas for different lengths of time. The antennas were the Yagi arrays used with ASV radar. The two beams were thus time-coded, giving "dots" on one antenna and "dashes" on the other. The equipment was placed at the windward end of the runway so that the equisignal path was directly down the runway.

The American version of this equipment used a portable responder beacon whose output was switched alternately to two transmitting antennas mounted vertically in front of a corner reflector (Fig. 7-30). The dual beam was time-coded in a similar way.

These earlier forms suffered severely from beam-shifting that resulted from changes in relative output power of the two antennas, from side lobes in the antenna patterns which gave false indications in the airplane, and from unstable transmitters. Consequently, they were dangerous to use in many locations.

More recently an antenna has been developed that does not produce this disastrous beam-swinging. A common transmitting and receiving antenna radiates a split beam that is formed by alternately switching energy to one or the other of two slots cut in a cavity resonator fed by a single-

probe radiator. The beam-switching is done in the antenna itself.

A similar antenna has been devised for a dual-beam glide path. Instead of dots and dashes, pulses of different width are used to distinguish the two lobes; each slot is fed for the same length of time but the length of the radiated pulses is different (5 and 12 μ sec for the two beams, for example).

Airborne Reception and Indication.—Several types of indication have been tried with various BABS systems. The double A-scope or L-scope has been used when the interpretation is done by a navigator or radar operator. When the airborne receiving antennas were dual, as in the early AI and ASV systems, the signal from each antenna was fed to one of the two A-scope sweeps (Fig. 7-31). Equality of signals indicated that the beacon was dead ahead. Range was indicated continuously and could be relayed to the pilot as needed. The relative amplitudes of the dot and dash pulses indicated angular position in the beam, and the comparison of the right and left amplitudes from the two antennas gave some indication of heading. Thus, when the airplane was flying down the center of the beam, headed directly toward the beacon, as at *a*, Fig.

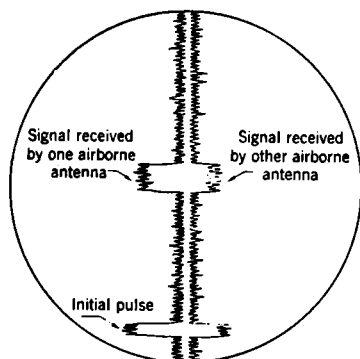

FIG. 7-31.—L-scope localizer presentation when used with dual receiving antennas.

7-32, the signal was a pulse of constant amplitude on each sweep and of equal amplitude on the two sweeps. At position *b*, the short pulses predominated and at position *c*, the longer pulses predominated. Since the airplane is headed toward the beacon in each case, the right and left amplitudes are always the same.

This alternately collapsing and expanding display was too difficult to interpret and too insensitive to small changes of position and heading to be of much use to anyone but an extremely well-trained operator. It has been abandoned in favor of very rapid alternations of pulses of different durations in the two lobes of the beacon antennas.

Figure 7-33 is the presentation obtained with systems using dual beams that are coded by changing the pulse length and in which the airborne antennas are single arrays. The

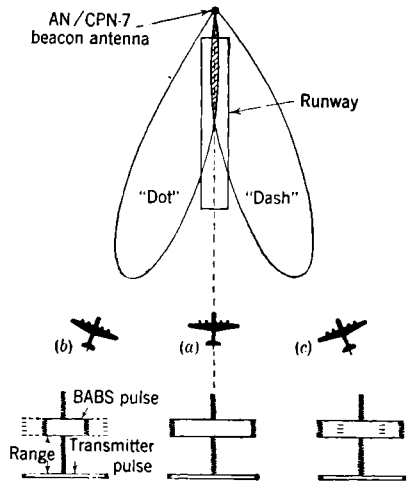

FIG. 7-32.—L-scope presentation of American 200-Mc BABS system. The three indicator presentations *a*, *b*, and *c* correspond to the three different positions of the aircraft.

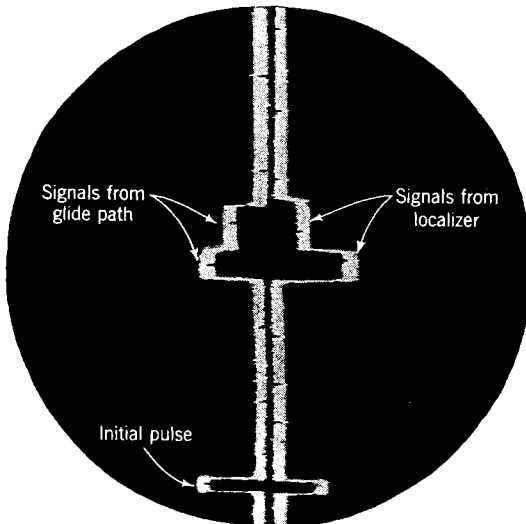

FIG. 7-33.—Airborne indicator for recent British BABS system. L-scope presentation.

localizer presentation is on one time base of the L-scope and the glide path on the other. Both long and short pulses of the two beams appear on the same sweep; deviation from the center of the beam is judged by the relative amplitudes of the two signals. No direct indication of heading is given.

If the localizer beam looking out to the right of the runway and the lower glide-path beam are coded with the shorter pulse lengths, the presentation shown in Fig. 7-33 indicates that the aircraft is to the left of the course and below the glide path.

This type of presentation has been successfully used by trained operators. Because these scope presentations are far too complicated for general use by pilots a circuit has been devised to present the variations of amplitude of the two pulsed beams on a cross-pointer meter. Both localizer and glide-path information can be presented in this way. In addition, automatic tracking circuits have been used to present the range on a meter in front of the pilot.

Trial flights indicate that these meters are at least as practical as similar cross-pointer indications used with c-w beam systems on the same frequency band. The continuous-range meter was found to serve as a monitor on the beams, giving the pilot an additional indication that the ground equipment was operating.

Rates Technique.—The availability of continuous-range data in the airplane has led to the experimental use of a valuable technique that indicates to the pilot his rate of approach toward the path he wishes to fly. Although this technique can be used for both the glide path and the localizer, it is discussed here only in terms of azimuth. The pilot can be given an indication of his rate of approach to the desired path in a direction perpendicular to it. By making this rate of approach proportional to the displacement from the path, even a fairly inexperienced pilot can make a creditable approach along a path that approaches the desired path asymptotically.

Evaluation.—The possible advantages of beacon systems as compared with c-w and pulse beams on the same frequency bands are:

1. The reduction of interference between several installations resulting from the small portion of the total time that any given beacon is operating.
2. Identification of ground stations and reduction of interference by use of appropriate channels.
3. Range information continuously available in the airplane.
4. Possible use of the rate-of-approach technique.
5. A fair presentation of information to the operator and pilot on the cathode-ray tube. Advantages 3 and 4 should make flying easier, however, if the information is given to the pilot by suitable meters.

Its disadvantages with respect to other beam systems on similar frequencies are that:

1. The inclusion of additional functions makes the airborne equipment heavier, bulkier, and more complicated than simple beam receiving equipment.
2. Cathode-ray tube information can be used to best advantage only by a highly trained radar operator and a pilot working together. This characteristic limits its use in civilian flying.

The possibilities of microwave BABS equipment would seem to give the added advantages over the lower-frequency system, discussed in the previous section. Airborne microwave interrogator-responders are feasible but would probably be heavier.

The beacon technique is well-advanced. Microwave beacons used with proper antennas could produce dual glide paths and localizers that would reduce the reflection and siting problems encountered at lower frequencies.

Although it is clear from the above discussion that systems of the BABS type are improved beam systems, they are subject to some of the fundamental limitations already noted, namely:

1. Dependence of the reliability of the information on constancy of the intensities of the beams.
2. Lack of means for warning pilots of obstacles.
3. Lack of means for giving warning of the presence of other aircraft on the glide path.
4. Complication of airborne indication.
5. Limited information available for traffic control.

Beacons have been used experimentally for a method of handling traffic in which the pilot is notified to circle the airport at a given constant range from the beacon. A holding pattern of concentric circles is then formed in which airplanes are flying circular paths at different fixed ranges. They are then successively cleared from inner circles into final approach.

7-8. Ground-based Scanning Radar Systems.—A significant contribution to instrument landing made during the war was the use of ground-based scanning radar for obtaining accurate relative position of a landing airplane with respect to a safe path of descent to a runway, combined with "talk-down" techniques for giving information and instructions for landing to the pilot by voice radio.

The prime equipment produced for these purposes was the ground control of approach system, GCA, built in considerable quantities in this country for use by the United States Army and Navy, and by the British.



FIG. 7-34.—AN/MPN-1 in operating position at fighter-bomber base near Verdun, France, March 1945.

In the later phases of the war in the European, Aleutian, and Pacific theaters GCA (AN/MPN-1) proved to be a versatile emergency landing facility that could be used by any type of aircraft. It was used with safety even by relatively inexperienced instrument pilots under conditions of ceiling and visibility worse than those that would permit use of the fixed-beam system. The GCA, having served with distinction during the later stages of the war, emerges as an important weapon in the battle for achieving all-weather civilian flying.

The basic concepts of the GCA system—its method of obtaining data on the position of the airplane relative to the runway, the kind of data obtained, and the method of presentation to the pilot—all depart radically from traditional glide-path-localizer techniques developed before the war.

The AN/MPN-1 (see Fig. 7-34) is a self-contained mobile unit consisting of two radars, a 10-cm search radar, and a 3-cm sector-scanning system that covers a limited volume of space surrounding the final path of descent. All equipment is compactly housed in an operations trailer. The trailer contains the two radars and the operating positions for the crew of six: four scope operators, the controller of the final approach, and the crew supervisor (Fig. 7-35). Since AN/MPN-1 was designed as a complete control unit in itself for use in forward areas, the trailer contains complete radio equipment for communicating with both landing aircraft and the control towers at the airport. The truck contains the prime power generators, air-conditioning units, tools, etc.

The primary function of the search system is to detect and identify individual airplanes coming into the landing zone and, by instructing the pilot over voice radio, to guide the airplane through an approach pattern into a rough alignment with the final descent path at a distance of from 4 to 10 miles from the field. The search set thus feeds the airplane into the region where the 3-cm scanning beams are operating and where the pilot receives more precise information as to his position.

The search antenna was designed to cover those regions in which airplanes approach the airport for a landing. It was not meant to provide high angle coverage over the airport for airplanes passing through the region. The antenna consists of an 8-ft linear dipole array which feeds a semicylindrical reflector with parabolic cross section, both mounted vertically on top of the trailer. The beamwidth is approximately 5° in azimuth with a cosecant-squared coverage extending in elevation from 3° to 10° above the horizon. The peak of the beam is normally at the 3° angle of elevation in order to minimize ground clutter. The requirement for frequent search information when airplanes have to be controlled accurately at short ranges, 10 to 30 miles, is met by scanning the search array through 360° in azimuth at 30 rpm. With a transmitted pulse power of 100 kw the search system is capable of detecting airplanes at

ranges of 15 to 30 miles at angles of elevation of 2° to 10° with an upper limit of about 5000 ft in height.

The search data are presented on two identical 7-in. PPI's equipped



FIG. 7-35.—Interior of operations trailer showing Army operating crew. Left to right: elevation tracker, controller, azimuth tracker, traffic director, airplane selector (checking transmitter rack). Officer-in-charge shown in profile. Verdun, France, March 1945.

with switchable range scales of 7.5, 15, and 30 miles (Fig. 7-36) and with a compass rose and heading lines. The two PPI operators, the traffic controller, and the airplane selector, although supplied with identical information, perform different functions in normal GCA operation.

The controller observes the traffic entering the area and identifies those airplanes calling in for landing instructions by requesting unique maneuvers, by the use of auxiliary aids such as ground-direction-finding information, or by the pilot's giving his position as obtained from other navigational aids. The traffic controller normally guides the airplanes through a definite traffic pattern, turning them over to the airplane selector at some predetermined point, generally on the cross-wind leg. The airplane selector guides the airplanes into the narrow sector covered

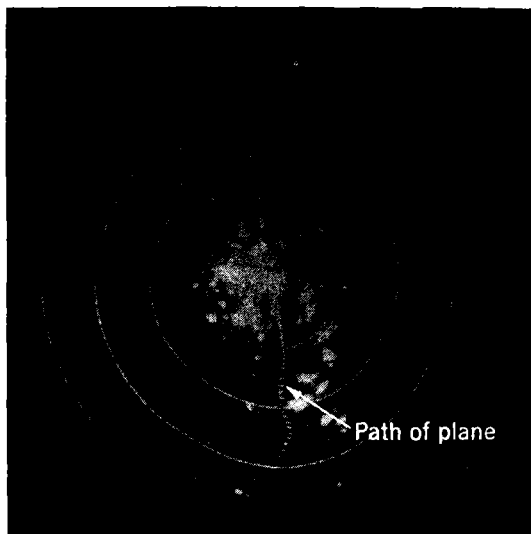
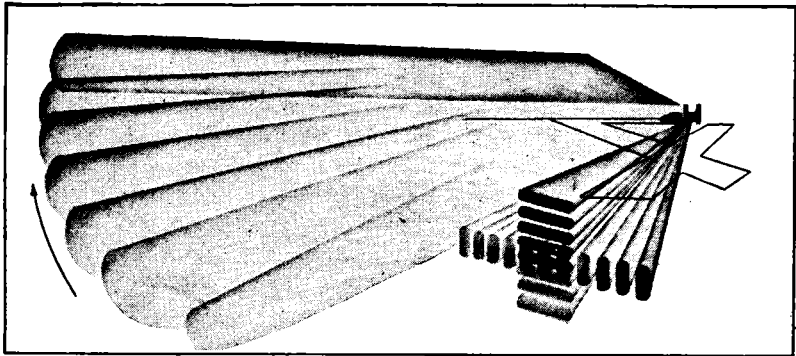

FIG 7-36.—Photo of GCA PPI showing ground track of an airplane making a ground-controlled approach (obtained by taking successive exposures every 4 sec of PPI signals, hence ground clutter greatly overexposed). Range circles every two miles.

by the 3-cm scanning system until the airplane is being tracked by the precision operators and the final approach controller takes over for the final landing instruction.

Separate communication frequencies have been provided for each PPI operator. In general practice, however, it is not possible to use three frequencies in the landing procedures, two for the PPI operators and one for the final controller. With single airplanes, one frequency passed along from operator to operator suffices. But when two to four airplanes are being handled simultaneously, two frequencies are required, at least one being reserved for PPI operation.

The GCA search function was not designed to serve as a full traffic control system to ensure adequate time separation in the arrival of a large number of aircraft at an airport; its effectiveness in moderate



(a)

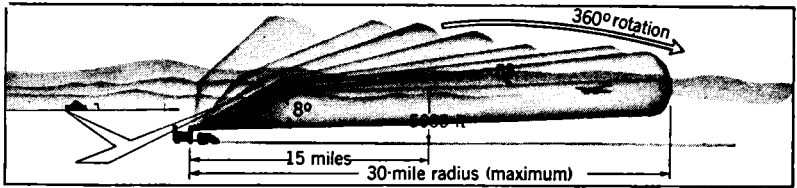

(b)

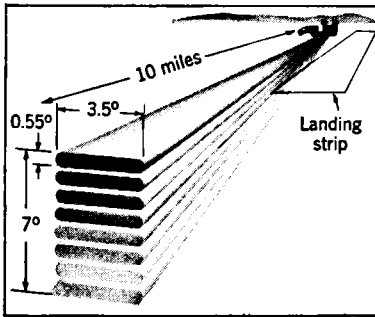

(c)

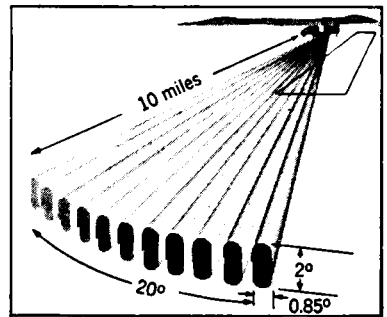

(d)

FIG. 7-37.—Antenna beam coverages of the GCA system. (a) GCA alignment with runway and search and precision scanning beams. (b) Search-antenna beam coverage. (c) Elevation beam scans vertically from -1° to $+6^{\circ}$ in elevation. (d) Azimuth beam scans horizontally over 20° sector.

traffic must not be underestimated, however. When airplanes arrive every 3 min or when the situation is such that the traffic controller can pull out the bottom airplane from a stack of planes every 3 min, 15 to 20 airplanes can land per hour by the use of GCA.

The GCA system is the first landing aid that has been used to help solve the approach zone traffic problem by effectively feeding airplanes into the final approach. For the first time, quantitative navigational information is available to the pilot when outside the narrow sector of the descent path. As a result the time-consuming procedures of orientation and bracketing on range legs and localizers are eliminated.

The final letdown approach to visual contact with the runway is observed with the 3-cm system, generally referred to as the precision system. Two narrow fan beams, one scanning in azimuth and the other in elevation, locate the airplane in an area 20° wide in azimuth up to 6° above the horizon in elevation, and within a range of 10 miles. Figure 7-37 shows the coverage of the three antenna beams of the GCA. The elevation beam has a one-way half-power width of 0.55° in elevation and 3.5° in azimuth. The azimuth beam has a one-way half-power width of 0.85° in azimuth and 2.0° in elevation. The approximate location of the trailer on the field is shown in the figure. The unit is normally sited on the right-hand side of the runway (looking out toward the airplane approaching at the upwind end of the landing strip), 200 to 500 ft from the center of the runway, and 2000 to 4000 ft down the strip from the approach end so that the airplane can be "seen" to touchdown. The coverage of the azimuthal scan is from 5° on the right side to 15° on the left side of a line parallel to the center line of the runway and running through the center of the trailer.

These fan beams are each produced by a dipole array that is fed by a squeezable waveguide placed along the focal line of a semicylindrical reflector of parabolic cross section. Figure 7-38 shows the combination of the two antenna arrays and a cross section of the waveguide portion of the arrays. The beam is scanned electrically by varying the width of the waveguide periodically—that is, by moving one of its sides parallel to itself. The two arrays are alternately fed power from the same transmitter. The scan cycle is such that each antenna beam sweeps through a complete cycle (two looks) in 2 sec. A scan rate four times as fast as this is available for operation at short range.

The data received from each of the precision scans is presented on a separate pair of 7-in. expanded partial PPI's, one having a 10-mile range and the other a 2-mile range, that is, a five-fold expansion of the final 2 miles. Two operators, the azimuth tracker and the elevation tracker follow the airplane signal on their respective pairs of indicators. Movable lighted cursors (Fig. 7-41 shows an elevation cursor) superimposed

on the indicators are controlled through operation of a handwheel by each operator so that they constantly bisect the signal of the incoming airplane.

The expanded partial PPI presentation reproduces on the tube the sector scan of the antennas multiplied in angle. The sweeps are altered to show objects at constant range along straight lines. In this way linear measurement on the scope face corresponds to linear measurement in space. Thus, the elevation scopes are range-height presentations with height measured in a direction parallel to the range lines; azimuth scopes

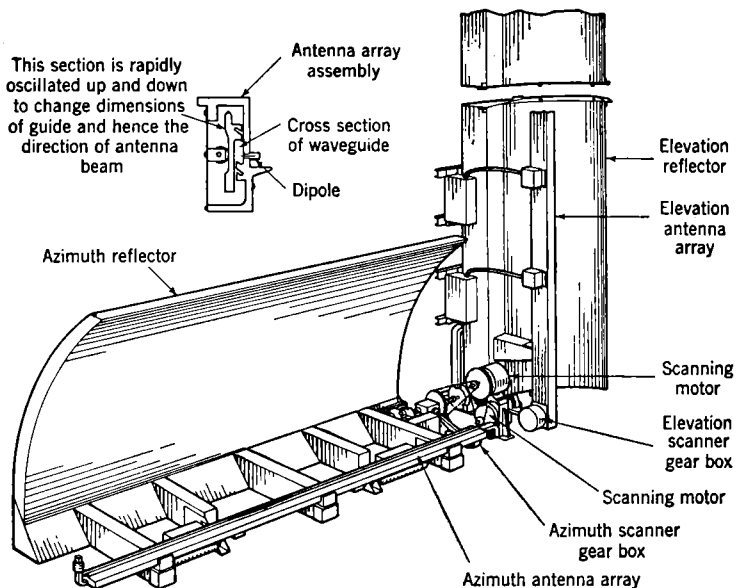

FIG. 7-38.—Details of GCA azimuth and elevation assemblies. (Courtesy of United States Army.)

permit lateral measurement right or left of the center line of the runway in a direction parallel to range lines. Figs. 7-39, 7-40, 7-41 and 7-42 illustrate both types of presentation for fast and slow sweeps.

Lines can be drawn on the faces of the indicator tubes representing a safe descent path both in elevation, the glide path; and in azimuth, the center line of the runway. (Actually, all GCA scopes are viewed indirectly through a half-silvered mirror so that the indicator face is seen superimposed on map surfaces on which the lines mentioned above are drawn.) The tracking cursors are geared to potentiometers whose voltage output is fed to sensitive error meters in front of the final-approach controller (Figs. 7-43 and 7-35). The circuits are so adjusted that when the tracking cursors are made coincident with the desired

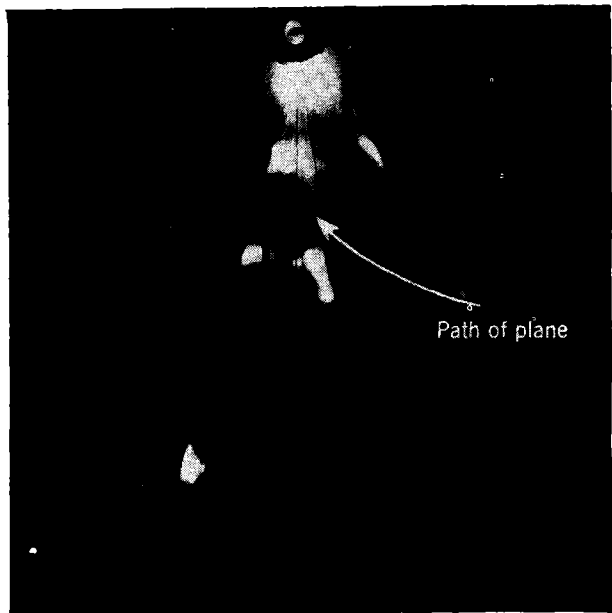

FIG. 7-39.—GCA azimuth precision indicator showing successive positions (every 4 sec) of airplane making a ground-controlled approach. Range lines every $\frac{1}{2}$ mile.

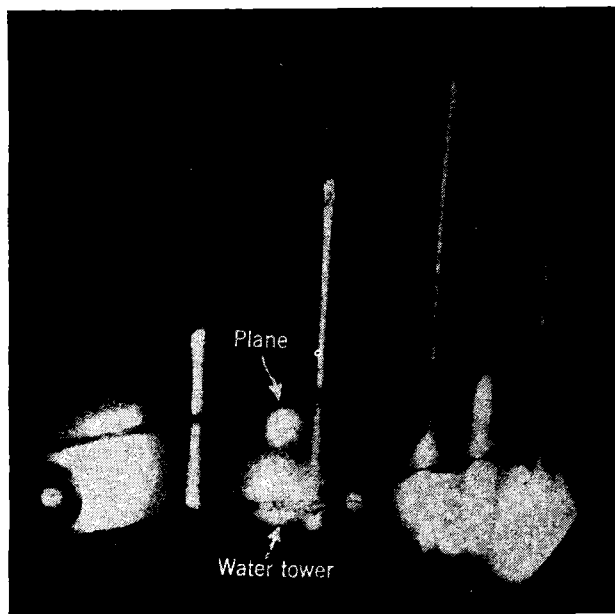

FIG. 7-40.—GCA elevation precision indicator showing airplane flying at elevation of 100 ft above 40-ft water tower at airport boundary, 4000 ft in range from GCA trailer.

LONG INC.
TECHNICAL RESOURCES

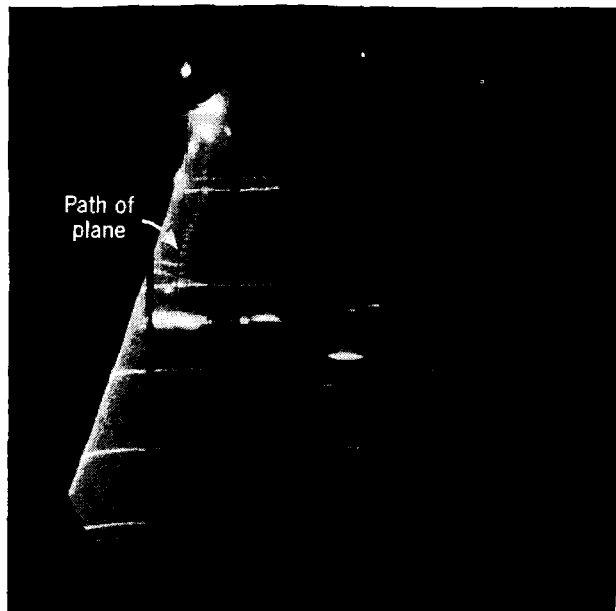

FIG. 7-41.—GCA azimuth precision indicator (10-mile sweep) showing successive positions of airplane making a ground-controlled approach. (Companion picture to Fig. 7-42 covering same region.)

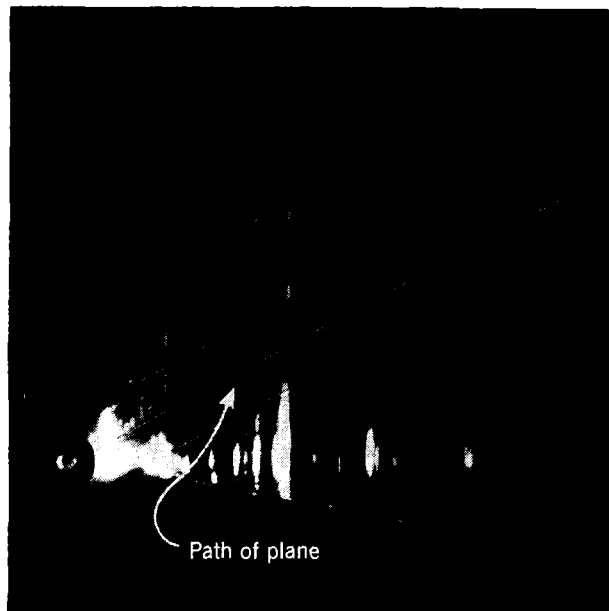

FIG. 7-42.—GCA elevation indicator (10-mile sweep) showing successive positions of airplane making a controlled approach. Lighted cursor shows safe 3° glide path. Note changes of rate of descent.

flight path, these error meters indicate zero error. The process of tracking the airplane signal by displacing the cursors in a direction parallel to the range lines, then, feeds to the controller's meters a quantitative measurement of linear deviation of the airplane from the desired path in the two coordinates, elevation and azimuth.

Since the indicators are used as measuring instruments, they must be reliable and easy to calibrate. Careful electronic regulation is used

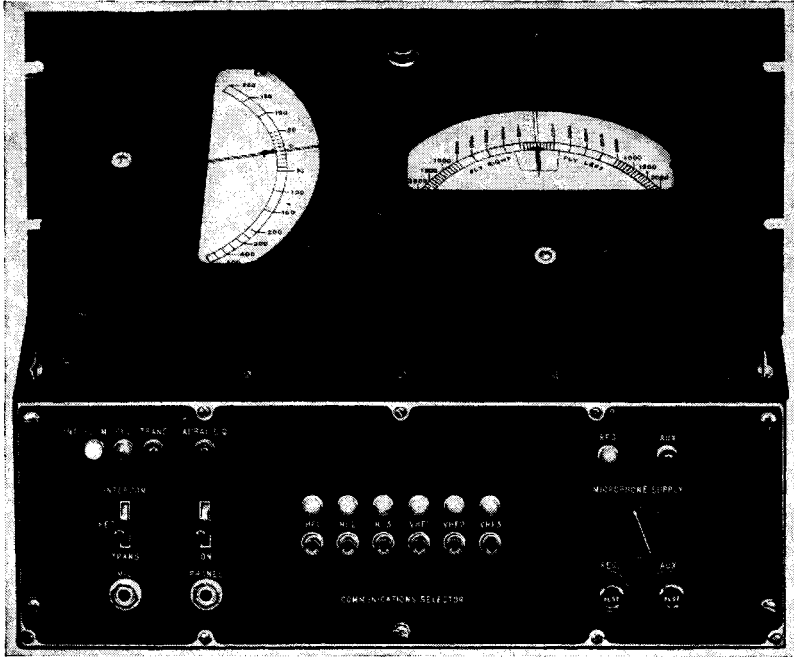

FIG. 7-43.—Controller's error-meter panel (AN/MPN-1A). (Courtesy of Bendix Aviation Corporation.)

throughout the indicator circuits to ensure stability. Furthermore, the final precise alignment of the system and the calibration of the indicators is done by using signals from corner reflectors (Sec. 9·4) permanently placed on the field at surveyed positions. The operator can monitor his presentation constantly and make any necessary readjustment immediately, by observing the signals from these corner reflectors.

One other important function of the operator must be mentioned. Figure 7-37 shows the dimensions of the scanning beam. The azimuth beam, for example, while scanning through an angle of 20° in azimuth, has only a 2° coverage in elevation. Obviously, to see an airplane which may be at any elevation up to 6° , the beam must be centered on it in

elevation by tilting the whole azimuth antenna assembly around a horizontal axis. This is done by the elevation tracker who controls the elevation adjustment of the azimuth antenna by foot pedals in the indicator rack. The position of the antenna is indicated on his cathode-ray tube by an additional transparent cursor linked to his foot pedals. By keeping the cursor roughly aligned on the airplane signal, the elevation tracker makes sure that the azimuth operator can see this signal on his indicator. A similar arrangement permits the azimuth tracker to adjust the position of the elevation antenna in azimuth. (In Fig. 7-42 the antenna-follower cursor is clearly shown.)

The final controller has available on his error meters the linear deviation of the airplane in azimuth and elevation from the desired path and can obtain from either of his trackers continuous data on the range of the airplane. By observing the motion of his error-meter needles, he gets an indication of the rate of closing to the path. From these data and observations on wind drift he controls the descent of the airplane by giving instructions to the pilot on the changes in heading and rate of descent necessary to keep the airplane on the proper path. He warns the pilot of the presence of any aircraft on collision courses and of his proximity to dangerous obstacles on the ground. It is his responsibility to give orders to pull the airplane out of its approach if at the specified safe minimum altitude the airplane is not in a proper position to land or if there is evidence that ground equipment is malfunctioning. Since he is acting as the pilot's "second brain" he must be very familiar with the landing characteristics of various aircraft and the landing procedures. The entire crew must be carefully trained and ever alert to the various emergencies that arise in instrument landing.

Advantages and Limitations.—GCA equipment was used with phenomenal success during its first year of operation. It made possible several thousand instrument approaches and numerous emergency landings under conditions of very poor visibility and often with pilots who had never previously made an approach under GCA supervision. This record indicates that the system possesses a number of exceptional attributes lacking in other landing aids.

1. Since it feeds information to the pilot over normal radio communications, the system requires no additional specialized gear in the airplane. It can therefore be considered a universal system if the proper communication channels are made available.
2. The information received aurally by the pilot requires little interpretation of data on his part because he does not have to pay close attention to additional meters or CRT's and is relieved of part of the burden placed upon him by the instrument flying condition.

- The radar information obtained through the use of narrow-beam scanning antennas is not subject to error caused by reflections from the ground, hangars, other aircraft, etc. The position of the airplane can be determined with an accuracy of approximately

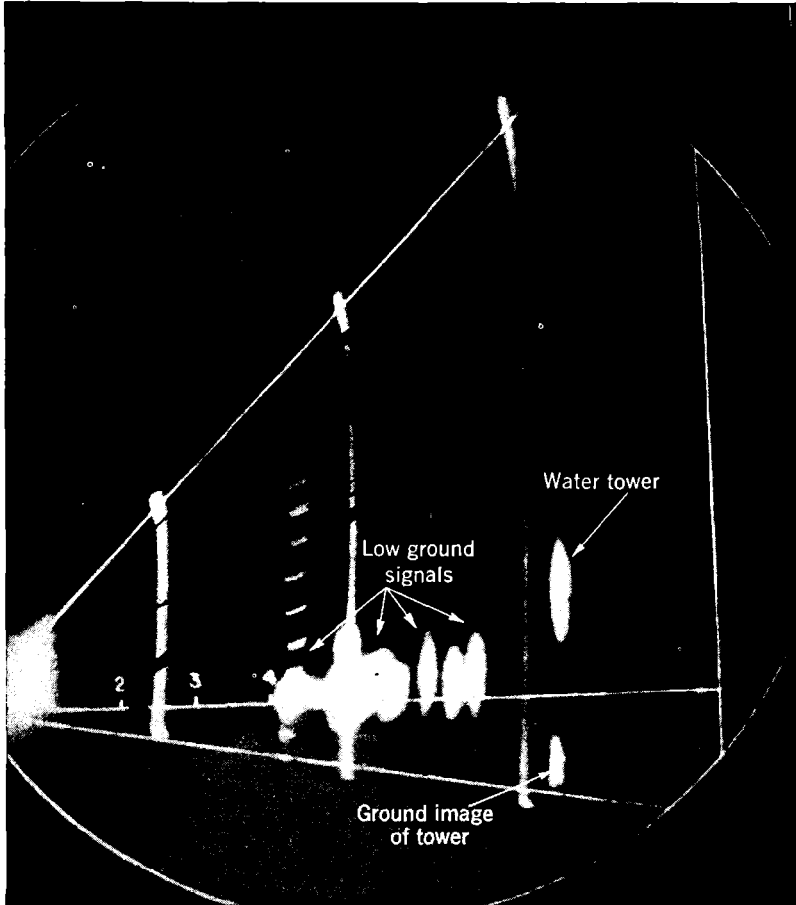

FIG. 7-44.—GCA elevation indicator (2-mile sweep) showing reflections from a water tower 135 ft high and also ground image of tower.

0.1° in elevation, 0.2° in azimuth, and 300 ft in range. This means that at a range of 1 mile, variations of 10 ft in elevation and 20 ft in azimuth can be detected. An example of ground reflection is shown in Fig. 7-44 where the mirror image of a signal from a water tank 135 ft above the ground appears below the

ground level. Ground-reflected energy that reaches the airplane and is returned is thus separated from the direct signal response until the airplane is less than 0.2° from the ground.

4. Signals from fixed objects close to the desired landing path, instead of being harmful, provide the ground crew with information as to the proximity of the airplane to these objects and the pilot can be told how to avoid them. Figure 7-40 shows the airplane signal clearly resolved from the ground return as it passes over a 40-ft tower with a clearance of 100 ft at a range of 4000 ft. Figure 7-39 shows the azimuth track of an airplane which has flown over the same obstacle.
5. The operators can give aid to all types of aircraft and provide glide paths within the range of 2° to 5° simply by realigning the elevation-tracking cursor to coincide with the proper glide-path line drawn on the map face.
6. The radar scope presentations permit constant monitoring of the alignment of the system, a tremendous safety factor that helps to increase the pilot's confidence in the system.
7. The system is provided with standby dual channel equipment for all components except antenna arrays and indicators so that a rapid changeover can be made upon failure of components in use.
8. The fact that the unit can be moved from runway to runway eliminates the inflexibility of single runway operation required with most landing aids. Any necessary realignment of equipment can be accomplished within half an hour.
9. It can be used by tired pilots or those who have had little or no previous experience with the equipment. Indoctrination of pilots and a few preliminary flights, however, help to familiarize the pilot with the procedure and establish his confidence in its reliability.
10. The traffic-handling capacity of the system is as great as that of any other landing aid that has been proposed and is greatly enhanced by its unique partial traffic control provided by the search system.

The following limitations have most frequently been pointed out by the critics of GCA: (a) large, highly skilled crews are needed for 24-hr service; (b) the system does not include a completely satisfactory identification system; (c) multichannel communication is required for landings in traffic of high density, particularly for closely adjacent fields; (d) there is the problem of language when GCA is used by pilots of different tongues; (e) the rate of landing is limited to one aircraft every 2 to 3

min; this is not a limitation under present traffic conditions but may develop into one.

Some of these limitations are being alleviated by improvements and new developments. The inadequacy of present communication facilities will be reduced with the widespread use of very-high-frequency multi-channel equipment. The language problem, already present in normal control tower operation, suggests that universal codes could be devised for the talk-down procedure.

The identification problem is greatly improved by presenting directly on the GCA indicators azimuth-bearing information obtained by radio direction finders.

The greatest progress in decreasing the requirement for operators, in increasing the traffic capacity of the system, and in improving the control information would result from direct reading of the indicators of the precision system by the controller. Although in the AN/MPN-1 the controller was placed between the two trackers in the expectation that he could view the scopes directly, the physical arrangement made it difficult for him to do so. Operational experience in controlling airplanes by using the azimuth and elevation indicators directly either by having both operators give instructions to the pilot alternately or having a single controller observe both indicators, has proved that there are considerable advantages to this procedure. Shorter controlled runs can be made with greater accuracy when the controller can observe the interrelation between the signal trails and the desired flight paths directly and instantly.

One manufacturer is developing a single tube on which both azimuth and elevation signals will be displayed simultaneously. It is hoped that this will permit reduction of the present team of three men for the precision system to a single controller. In regions of heavy traffic where landings at the rate of one per minute are desired, these indicators could be duplicated and a second controller could give instructions to a second airplane on the glide path.

Many instrument approaches are made under conditions that do not require the use of the full precision team, for instance, with ceilings of 500 ft or more and visibility of 1 mile. In many locations, descent under such conditions can be effectively controlled from the PPI alone if the pilot is told what his elevation should be as he approaches the field. If a remote PPI were to be provided in the control tower, such information could be used to speed up traffic by reducing the number of missed approaches that result from poor alignment in letdowns relying solely on radio range and localizers. The addition of the surveillance feature provided by ground radar is a *must* in future instrument landing procedures.

SPECIAL RADAR AIDS

7.9. Moving Target Indication.¹ *How MTI Works.*—MTI is a method of displaying radar echoes that discriminates between fixed and moving targets. The basic idea is to use some sort of clock to time the flight of the pulse out to the target and back. If the time interval is the same for each transmitted pulse, the target is fixed; if it varies, the target is moving. Suppose that 1000 pulses per second are sent out and that the target is moving toward us at 200 mph. Then the distance traveled

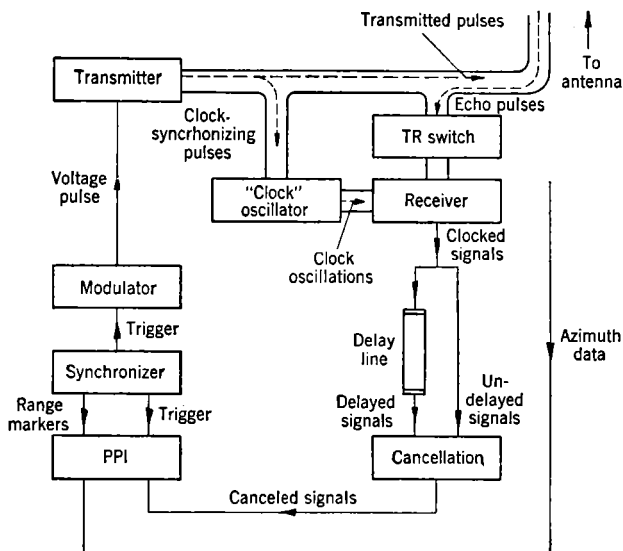

FIG. 7-45.—Block diagram of radar set with MTI showing the position of the "clock" oscillator and the delay line.

by the target between pulses is 0.3 ft. and the path traveled by successive pulses is continuously shortened by steps of 0.6 ft. The pulse travels this distance in only 6×10^{-10} sec; the clock must be able to measure this very brief time interval. The only clock that can do this is a high-frequency oscillator vibrating at about 3000 Mc/sec. The clock then goes once around in 3.3×10^{-10} sec, which is just about right for measuring the time interval under discussion.

Now, there are two questions to ask: How is the clock started, and how is it used to measure the returning echoes? It is started by the transmitted pulse which forces the r-f clock into step with itself. When the echoes return, their cycles are compared with those of the clock simply by adding the two sets of cycles together. After this has been

¹ By A. G. Emslie.

done, the resulting signals have all the necessary information; i.e., the signal from a fixed target stays the same size while that from a moving target fluctuates.

We can now arrange to keep the fluctuating signals and get rid of the steady ones by cancellation. The echoes from one transmitted pulse are delayed or stored until the corresponding echoes from the next pulse start coming in. The stored echoes are then subtracted from the newly arrived echoes and the net signals are displayed on the indicator. A block diagram of a radar with MTI, where a supersonic delay line is used to delay the echoes, is shown in Fig. 7-45.

The Delay Line.—In the supersonic delay line the electrical echoes are converted into high-frequency sound waves by a piezoelectric quartz crystal. The vibrating crystal transfers the sound waves to the medium of the delay line, which is usually a liquid contained in a metal tube. A similar crystal at the far end of the delay line turns the sound waves back into electrical impulses. Figure 7-46 shows one delay line that has been used. The steel tube, folded for compactness, is 16 ft long and uses mercury as the transmitting medium. The delay is $\frac{1}{3000}$ sec. The total weight of the line, including the supporting steel channel, is about 200 lb. For sets with a higher repetition rate the delay line is shorter and lighter.

Storage Tubes.—A storage tube can also be used to delay the echoes. In this case, they are converted into electrical charges and distributed over an insulating screen in a cathode-ray tube by being made to control an electron beam that sweeps over the screen. The stored echoes can be removed from the screen at a later time by sweeping it again with the electron beam. Because of difficulties caused by secondary electrons emitted by the storage screen, the storage tube has not yet been developed to a point where it can replace the delay line in MTI.

Performance of MTI.—Figure 7-47 shows how the application of MTI improves the appearance of the PPI. The ground clutter, which is about 1000 times as strong (in voltage) as the minimum detectable

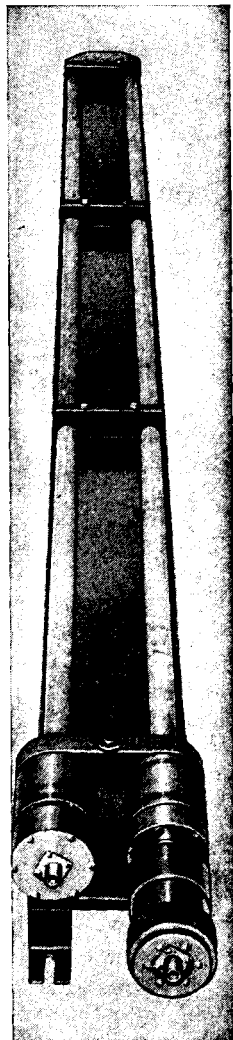

FIG. 7-46.—Delay line for use with MTI.

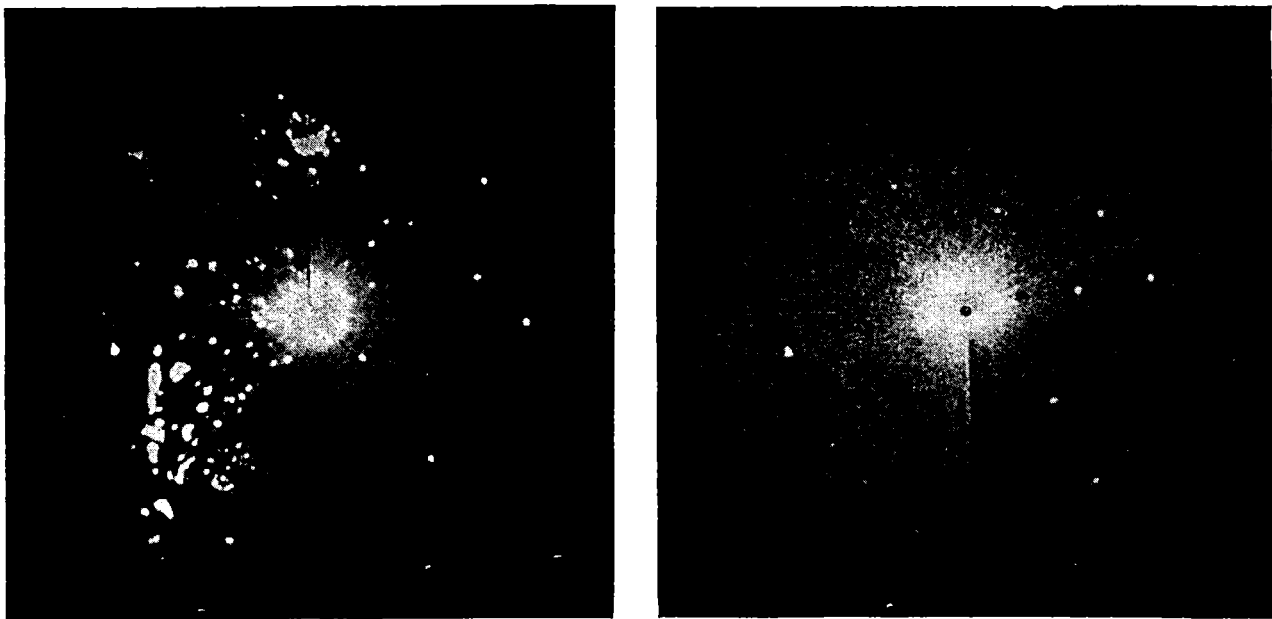

FIG. 7-47.—Comparative photographs with and without MTI showing how it eliminates signals from stationary targets.

signal, is canceled on the MTI photograph leaving nothing but moving targets.

In addition to removing ground clutter, MTI can cancel clouds, provided a high enough repetition rate is used. Figure 7-48 shows how the canceled signal voltage depends on the radial speed of the target. The graphs apply to 10-cm operation at repetition rates of 300 and 3000 pulses per second. The response is zero at those speeds for which the round-trip echo time changes by a whole number of cycles of the clock oscillator from pulse to pulse. It will be seen that, when the repetition rate is 300, there is considerable response at speeds as low as 10 mph. Thus, clouds do not cancel at such a low repetition rate. At 3000, on

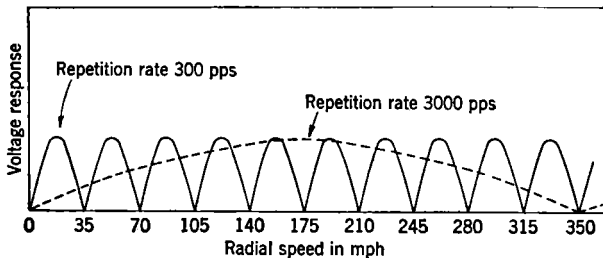

FIG. 7-48.—MTI response curves for 10-cm operation.

the other hand, the response is rather small at 10 mph and clouds cancel well.

MTI cannot be applied to rapid-scan systems because the ground clutter changes enough from pulse to pulse to make it indistinguishable from moving targets. What matters is the number of pulses per beam-width, which should be about 10 or more.

Shipborne and Airborne MTI.—The application of MTI to a shipborne radar for the purpose of aiding navigation is not nearly so straightforward as the application to a ground-based set. The problem here is to distinguish shore lines, buoys, and ships from sea clutter and clouds. If the repetition rate is high enough to cancel clouds, then everything else will cancel because the speeds relative to the ship are all of the same order of magnitude. Giving the ship a suitable virtual velocity by applying a correction to the clock oscillator at the time of each transmitted pulse will keep the repetition rate low and “stop” the clouds. The correction varies with the bearing of the particular cloud being canceled, but it could probably be fed in automatically. Because the virtual velocities required for clouds and sea clutter at a given bearing will not be the same, they cannot both be canceled simultaneously on the same indicator.

For aerial navigation, clouds should be eliminated and landmarks retained. Thus, the problem is similar to that just discussed but with emphasis on the high virtual velocity that an aircraft must have to make a cloud "stop." This condition poses a difficult technical problem for which no practical solution has yet appeared.

7-10. Beacons.¹ *Use of Airborne Beacons for Navigation*—The function of an airborne beacon is to reply, when interrogated by a ground radar, with a pulse or a series of pulses which can be received by the ground radar. A general description of radar beacons may be found in Sec. 1-9. Airborne beacons have been built in the 3000-Mc/sec region which can be seen at 300 miles by high-powered ground radars. They are coded for identification, weigh less than 40 lb, and require about 150 watts of power; similar beacons, slightly heavier and requiring more power, have been built in the 10,000-Mc/sec region. Beacons weighing as little as 7 lb have been built for operation at 200 Mc/sec, but their azimuth resolution is poor.

The advantages of using beacons are:

1. Range. The beacon reply is generally much stronger than the natural radar echoes from the same aircraft. Originally, airborne beacons were used to increase the range at which an aircraft could be seen. With the advent of high-powered long-range ground radars, this increase in range has become relatively less important.
2. Identification. Using the coding systems described in Chap. 1, each aircraft carrying a beacon can be identified.
3. Elimination of extraneous echoes. If the beacon does not reply on the radar transmitter frequency, the radar is insensitive to normal echoes when its receiver is tuned to the beacon frequency. Hence, ground clutter does not appear.
4. Communication. Since it is fairly easy to obtain a much larger number of codes than are necessary for aircraft identification, those remaining can be used for communication. This does not give the complete flexibility of voice communication, but does allow a large number of standardized messages to be handled—the reporting of aircraft altitude, for example. The various coding systems may also be applied to the radar signals which interrogate the beacon, making radar-to-beacon communication possible. In its present state the decoding equipment would probably be too heavy to justify its installation in an aircraft, but future developments and demands may alter this situation. Radar-to-beacon communication can be applied more easily when the radar "searchlights" the target than when it scans.

¹ By J. B. Platt and R. M. Whitmer.

Maximum and Minimum Ranges.—A well-designed long-range ground radar can see a lightweight airborne beacon anywhere above the radar horizon provided the aircraft is below an altitude of 35,000 ft.

Two factors affect minimum range. First, the beacon reply is often sufficiently powerful so that, if both receivers remain at high sensitivity, the beacon may be seen in the side lobes of the radar antenna pattern, or even through 360° of the scan. At close range, then, it would be impossible to locate the aircraft in azimuth. If sensitivity time control is used on the radar receiver, its sensitivity is decreased at close ranges. The second factor affecting minimum range is antenna pattern. Because both radar and beacon have antennas that radiate and receive little energy vertically, there may be so little coupling between antennas for an aircraft high above a radar even though at close range that the signal is lost. This situation may be avoided by proper antenna design.

Radar-beacon System.—We have seen that the combination of ground-based radar and airborne beacons makes possible location and identification of all aircraft within a control area, transmission of data from air to ground, and transmission of data or instructions from ground to air. The amount of permissible complexity in equipment limits the number of functions that a system can perform.

A system that would use a high-powered, scanning, ground microwave radar is presented as an example. This radar is equipped with separate radar and beacon receivers, whose two outputs may be presented simultaneously on the same indicators. Because the radar receiver output is delayed by an amount equal to the delay at the beacon, the beacon reply from a given aircraft is seen at the same point as the radar echo. The STC feature is included, as well as decoding apparatus to be described later. Let us suppose that every aircraft coming within the control zone of this radar carries a lightweight range-coded beacon with six code pips. The first code pip has the same delay (the minimum possible) for all beacons, and hence can be used for measurements of range. The second code pip can be delayed by the altimeter reading from 5 to 20 μsec , in steps of 1 μsec . Thus, the aircraft altitude, from 1 to 15,000 ft, can be transmitted. The remaining four code pips are factory-set in 1- μsec steps for identification in the following intervals: 25 to 34, 40 to 49, 55 to 64, and 70 to 79 μsec making a total of 10,000 "license numbers" available.

Decoding equipment at the radar might consist of an expanded A-scope, gated in range and azimuth, on which 1- μsec calibration pips are also displayed. To identify any aircraft and determine its altitude, the radar operator needs only to set the A-scope sweep to the azimuth and range of the aircraft in question. If the calibration pips were derived, say, from a pulsed crystal oscillator triggered by the first beacon

reply, the altitude and the identification could be read directly from the A-scope. Other arrangements with more complicated apparatus but simpler to operate can be conceived of; such a discussion, however, is beyond the scope of this book.

If the radar operator wants to see on his PPI display only those aircraft at a particular altitude, a filter could be used that would pass to the video input of the PPI only those beacon replies with the correct spacing between the first two pips. Thus, by changing a selector switch, the operator could see only that part of the air traffic between 8500 and 9500 ft, or only that part between 1500 and 2500 ft.

Thus, the radar operator—and through him the air traffic controller—knows the position, altitude, and identity of every aircraft within range of the radar.

It is obvious, however, that difficulties would arise because of the overlapping of the coded replies from two beacons at nearly the same azimuth and range. There is, therefore, an upper limit to the traffic capacity that beacons with such coding provisions can efficiently handle.

7-11. Radar Relay¹—In any practical system of air-traffic control it is probable that radar information will be transmitted to a remote station by means of a radio link. The process by which video, trigger, and angular synchronization data are transmitted to and received at some remote point is called radar relay. The design of such equipment is largely dependent on the particular function of the radio link; the complexity of the angle information to be transmitted, and whether or not directional antennas can be used, are important factors. The two most important types of radar relay link likely to be used in air traffic control are conveniently referred to as Type A and Type B.

Type-A Relay Link.—It is essential that traffic controllers at airports have accurate up-to-date information on the position of all aircraft within the region surrounding the airport. It may not be possible to place a search radar at the airport because in order to get adequate coverage the radar must be placed at a site that overlooks the surrounding terrain. Consequently, the information from the search radar will often have to be relayed back to the airport.

The more important characteristics of this link may be listed as follows:

1. The transmitting and receiving stations will be at fixed locations, i.e., it will be a point-to-point link.
2. Since the transmission path will be close to the surface of the earth, considerations of profile will arise.

¹ By J. M. Sturtevant.

3. The search radar will probably employ a circular scan of constant rate, making the problem of angle synchronization relatively simple.
4. There should be as much freedom of choice of presentation at the relay receiving station as at the radar. It should, for example, be possible to use simultaneously B-scopes or PPI's off-centered in various directions. This means that the output of the relay receiver must contain all essential information that is available at the radar station.

Links of this type may also be required to relay information from search radars distributed along the important traffic lanes to the various airport control centers. In this application the transmission path may be so long that intermediate relay, or "booster," stations will have to be used between the transmitting and receiving ends of the link.

Type-B Relay Link.—It may be advantageous to install relay-receiving equipment with an indicator in a commercial airplane. If this is done the pilot will have before him the complete information of the ground-based radars placed at strategic intervals along the air lanes. Such information is superior in many ways to that obtained by the use of lightweight airborne equipment.

The important characteristics of such a ground-to-aircraft link are as follows:

1. Because the receiving station is not at a fixed location, its range and orientation relative to the transmitting station will be changing constantly. The link will thus be nondirectional (except for a possible small degree of directivity in the vertical dimension).
2. Because the transmission path will usually be at a considerable elevation angle it will be relatively free from the limitations imposed by the terrain. In other words, whenever ground-based radar can detect the airplane, it will be possible to relay information to it. It will be seen later, however, that interference caused by reflections from the surface of the earth must be given more careful attention in Type-B links.
3. Angle synchronization presents more of a problem with Type-B than with Type-A links. It may be necessary to have a really tight system of synchronization of angles because more trouble is to be expected from fading and insufficient attention of the operator in an airborne relay receiver.
4. It is desirable to exercise considerable freedom of choice of display in the aircraft. Thus, if the aircraft is at a considerable distance from the ground-based radar it will be necessary to employ an

off-center PPI or some type of "blown-up" indication in order to utilize the full resolution and precision of the radar.

The General Design Problem.—Past experience has shown that the transmission of radar information by means of voice communication is unsatisfactory, chiefly because it is impossible to transmit more than a very small fraction of the available information in any reasonable length of time. A satisfactory relay system must therefore transmit two types of information, namely radar echoes and synchronization data. In order to preserve the excellent resolution and precision in range and azimuth of a microwave radar it is necessary to employ a broadband transmission system with an over-all frequency response flat from low audio frequencies up to a megacycle or more, depending on the pulse width of the radar. This requirement obviously rules out the use of ordinary telephone circuits for Type-A links. Coaxial transmission lines may be employed for moderate distances (up to a few miles).¹ Such lines having low enough attenuation to be useful for longer distances, together with the necessary booster and compensating amplifiers, will probably be more costly to install and maintain than a radio relay link.

The band of frequencies required for relaying radar information is no wider than that used for television. This suggests that a convenient relay system might be obtained simply by televising one of the radar indicators. This line of attack is receiving some attention but it is ruled out for present purposes because the presentation employed at the receiving end would be rigidly restricted to the particular display televised at the transmitter. Thus we are forced to devise relay systems in which "raw" radar video together with complete sweep and angle information are transmitted by a radio link in such a way that the choice of presentation at the receiving station is as wide as that at the radar.

Minimum Usable Signal.—Before proceeding further with a discussion of design it is important to point out that the concept of minimum usable signal strength is a very different thing in the relay system from what it is in the original radar. The received relay signals should be strong enough to prevent the relay receiver from contributing appreciably to the final noise level, even during periods of fading, if possible. It seems reasonable to specify that the received relay signal power should be at least 40 db above (10,000 times) the relay-receiver noise power during periods of normal (nonfading) propagation. We accordingly define the range of a relay system as the maximum distance at which this specification is fulfilled. It is to be noted that relay applications enjoy the very great advantage of one-way as compared to two-way radar transmission.

¹ See the interesting cost analysis by C. W. Hansell, *Proc. I.R.E.*, **33**, 156 (1945).

Choice of Frequency.—The two types of links will use different carrier frequencies. Type-A links should operate at very high carrier frequencies (10,000 Mc/sec or more), for the following reasons:

1. **High antenna gain.** Highly directional antennas can be employed in relaying information between fixed points. This means that relatively lightweight transmitters of low power can be used because the power deficiency will be taken care of by high antenna gain. Since only one-way transmission is being considered, if all other factors are held constant, doubling the frequency will result in an increase of 6 db (a power factor of 4) at the receiver terminals. In other words, the free-space range will be doubled. The following set of possible parameters will serve as a numerical example. Suppose a relay link is to operate at 10,000 Mc/sec. with 4-ft parabolic antennas at each end of the link. The transmitter power is to be 100 mw (easily realizable with a 419 klystron), and the receiver is to have a bandwidth of 10 Mc/sec and a noise figure of 12 db. If the antenna efficiency is 0.6, the free-space range (40-db signal) should be 55 miles, a satisfactory distance for most Type-A links.
2. **Narrow beamwidth.** High-gain antennas lead to narrow beamwidths, which by minimizing possible difficulties arising from accidental or intentional interference are advantageous in point-to-point relay links. Some thought must be given to what minimum beamwidth is consistent with the mechanical limitations imposed by the rigidity of the antenna towers and the difficulty of lining up the transmitting and receiving antennas.
3. **R-f bandwidth.** In some Type-A applications it may be desirable to have several relay links feeding into one receiving station. If this necessitates the use of booster stations to surmount intervening obstacles, several r-f channels must be available in order to avoid interference. Since equipment can be designed to cover a much broader band at high than at low frequencies, a larger number of channels can be fitted in at the high frequencies.

The problem of frequency control resulting from the use of a high carrier frequency has been solved recently in a satisfactory manner by the use of an r-f discriminator,¹ which makes tuning at 10,000 Mc/sec almost as easy as it is at ordinary broadcast frequencies.

Type-B links will probably have to operate at relatively low frequencies, about 500 Mc/sec. In a nondirectional link, brute force of

¹L. M. Hollingsworth, H. Logemann, Jr., A. W. Lawson, Jr., J. M. Sturtevant, "An X-band Frequency-modulated Relay System for Video Frequencies," RL Report No. 977, Jan. 3, 1946.

high transmitter power is the chief means available for obtaining sufficient signal power at the receiver. A small antenna gain in the vertical dimension can be used, possibly 4-fold for the airborne and 30-fold for the ground antenna. No very-high-frequency oscillator tubes are now available with power outputs of the order of several watts which can be frequency- (or amplitude-) modulated with any degree of linearity and without a great deal of spurious frequency or amplitude modulation. High-frequency transmitters with relatively high power output in which a low-frequency oscillator is frequency- or phase-modulated, and whose output is then subjected to several steps of frequency multiplication and power amplification have been built. This procedure, however, requires bulky and complicated equipment. Present techniques, therefore, limit the carrier frequencies for nondirectional systems to values of approximately 500 Mc/sec, where modulation and power amplification can be readily accomplished. High transmitter power is a very important factor in a nondirectional relay link. For example, suppose a transmitter operates at 500 Mc/sec, antenna gains are 5 and 15 db at the airplane and ground ends of the link, respectively, and the receiver sensitivity is 10^{-13} watt (so that the received signal should be 10^{-9} watt). A transmitter power of 40 watts will be needed then to give a free-space range of 100 miles.

Although propagation factors do not greatly influence the choice of carrier frequency, they should not be overlooked. Four of the more important factors and their relations to the carrier frequency selected are discussed briefly.

1. Interference effects. Interference effects result when radiation reaches the receiver either by a direct path or by one or more paths involving reflection. The important reflections are those of microwave radiation from water surfaces, and of radiation of longer wavelengths from both water and relatively level ground surfaces. It has been found that there is little reflection of microwave radiation from relatively smooth terrain. The interference resulting from these reflections is briefly discussed in Sec. 10-1 and in detail elsewhere.¹ The points of interest here may be summarized as follows:
 - a. Difficulties can be avoided in point-to-point links if the antenna heights are such that the receiving antenna is at the point below the maximum of the first interference lobe. This condition exists when the reflected path is one sixth of a wavelength longer than the direct path. This criterion² represents a compromise between

¹ *Propagation of Short Radio Waves*, Vol. 13, Radiation Laboratory Series.

² C. W. Hansell *loc. cit.*

greater signal strength and increased cost of antenna towers. It can be shown that the antenna heights H , measured in feet, needed to satisfy this criterion over a path of L miles at a wavelength of λ centimeters are given by

$$H = 0.123L^2 + 3.8 \sqrt{\lambda L}.$$

The first term on the right represents the antenna heights necessary to obtain a line-of-sight path over a smooth spherical earth.

- b. Interference effects in Type-B links will cause fading as the aircraft moves in the lobe pattern of the transmitter. Since Type-B links will operate at relatively low frequencies, such effects may result from ground as well as water reflections. The only way to alleviate this difficulty is to have the lobes in the transmitter pattern as close together as possible. This is accomplished by using the highest possible frequency and the highest possible antenna at the ground station.
2. Shielding effects. Radiation at frequencies of interest in the present connection is restricted to line-of-sight propagation paths since there is no appreciable ground wave. Practical experience¹ with microwave links has shown that the line-of-sight criterion is actually not stringent enough; fades presumably caused by changes of refraction are more severe if the transmission path comes too close to grazing an intervening object. A more satisfactory criterion appears to be that the first Fresnel zone of the beam should be clear of all obstructions. According to this criterion, the line-of-sight path should clear any obstruction by a minimum height h feet given by the expression

$$h = 13.2 \sqrt{\lambda l},$$

where l is the distance in miles to the transmitter or receiver, whichever is nearer.

3. Refractive changes. Fades caused by abnormal refraction will occur with both Type-A and Type-B links, and little can be done about them. The level of the normal relayed signal therefore must be high. The observations of Durkee indicate that fading is less troublesome in Type-A links operating at microwave frequencies if the path lengths do not exceed 30 to 35 miles.
4. Atmospheric absorption. Since absorption caused by atmospheric moisture and oxygen may become serious only at frequencies above about 15,000 Mc/sec, this factor needs to be considered only in Type-A links. According to S. C. Hight² a light rain

¹ A. L. Durkee, BTL Report MM-44-160-190, August 1944.

² S. C. Hight, BTL Report MM-44-170-50, Oct. 1944.

(precipitation of 1 mm/hr) causes attenuations at 10,000 and 30,000 Mc/sec of 0.05 and 0.33 db per mile, respectively. These figures correspond to absorptions of 68 per cent and 99.95 per cent in a path 100 miles long. Cloudburst precipitation (100 mm/hr) causes attenuation 100 times greater; such intense rain squalls, however, are very rare in many parts of the world, and are likely to be restricted in area.

Intermediate Stations.—Type-A links may sometimes require intermediate stations in order to surmount hills or to prevent serious fading over long paths. Ideally, a repeater station would consist simply of a receiving antenna, an r-f amplifier, and a transmitting antenna. Because good r-f amplifiers are not now available at the high frequencies recommended for point-to-point links, it is usually necessary to place “back-to-back” a receiver and a transmitter operating on different frequencies. This procedure is entirely satisfactory in spite of its apparent cumbersome nature, provided distortion of signals is carefully avoided. Such distortion accumulates rapidly if the individual transmitters and receivers are not accurately linear in their over-all amplitude response.

It may be mentioned here that the apparently simple device of two large antennas back-to-back, or a system of two large plane reflectors at 45° to the line of the beam, is not a satisfactory means of carrying a relay beam over an obstruction, except possibly in the case of very short links. A rough computation of power levels to be expected and a consideration of line-up difficulties resulting from the extremely narrow diffraction patterns of such reflectors show this to be true.

Amplitude or Frequency Modulation.—Because the types of atmospheric and man-made interference against which frequency modulation gives a large measure of protection at low frequencies, do not have appreciable components in the region above 300 Mc/sec, there is no clear-cut choice between amplitude and frequency modulation for relay work. H. M. James¹ has analyzed the situation and has concluded that “reliably predictable differences between a-m and f-m systems are either not very great or not very important, and it appears that under present conditions considerations of availability and cost can reasonably be made the primary basis for decision.”

Multichannel Transmission.—In some applications more than one channel of radar information may have to be transmitted. For example, it may be important to transmit from a ground-search radar to aircraft in the vicinity both the radar echoes and a video map, or some sort of height information may be essential. It is highly desirable that such multichannel data be transmitted over a single high-frequency relay

¹ H. M. James, RL Memo, March 23, 1945.

channel. Multiple simultaneous modulation of a single r-f channel, such as is used in multiplex carrier telephony, has not yet been developed at very high frequencies nor with broadband modulation signals, though there is no obvious reason why such methods could not be worked out.

The method most available now for multichannel transmission is that of time-sharing. Two types immediately suggest themselves; one in which each radar repetition interval is divided into two or more sections during each of which a different type of video is transmitted; and one in which, for example, one type of video is transmitted for one or more full repetition intervals, followed by a second type for one full interval.

The first system leads to a mixed presentation at the receiving indicators and will probably not be of any importance in the present connection. It requires no special provision for synchronization. The second type allows the two kinds of videos to be separated at the receiving end; a method of accomplishing the necessary synchronization of the transmitting and receiving video switches is described elsewhere in this series. If a video channel is transmitted for a fraction a of the repetition intervals, it will suffer a loss in effective signal-to-noise ratio of $-5 \log a$ db because its repetition rate is, in effect, decreased by the factor a . Thus, if two channels share the time equally each will lose 1.5 db¹ in signal-to-noise ratio.

Synchronization.—Since the general question of synchronization is discussed at some length elsewhere in this series (*Electronic Time Measurements*, Vol. 20, Chaps. 10 and 11, RL Series), only one simplification that could probably be worked out for a link designed to relay data from a radar employing a steady circular scan is mentioned here. With such a link, angle synchronization, which is, in general, the most difficult aspect of the synchronization problem, could be accomplished by careful and separate control of the rate of rotation of both the radar antenna and the receiving PPI. The receiving PPI could then be easily brought into step with the antenna by transmitting a north marker mixed with the radar video signals. If several indicators were to be used at the receiving station, the rate of rotation of one or more synchro generators supplying normal angle information would be controlled.

Summary.—In the preceding pages, the more important points to be considered in the design of the relay systems that might be of use in systems for air-traffic control have been discussed briefly. Particular attention should be paid to the Radiation Laboratory Report² which describes in detail what is probably the first ultra-high-frequency (10,000

¹ For a discussion on gating circuits for video switching see J. M. Sturtevant and E. W. Samson, "Synchronization Systems for Ground Radar Relay," RL Report No. 978, Nov. 1945.

² Hollingsworth, et. al., *op. cit.*

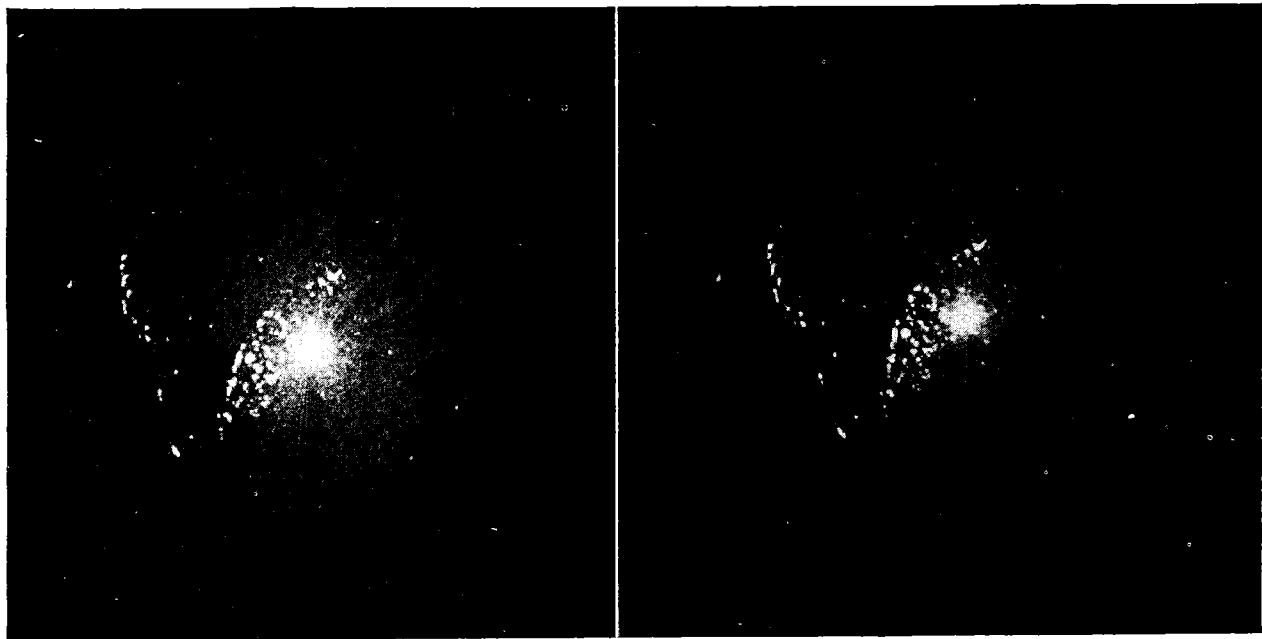

FIG. 7-49.—Radar relay. The two photographs were taken simultaneously. The data presented at the left have been transmitted by radar relay and presented on the remote indicator at the right.

Mc/sec) transmitter and receiver for relaying broadband information. This equipment, though still in the experimental stage, was found to be satisfactory in preliminary tests. Figure 7-49 is a good illustration of the lack of distortion in this equipment. On the left is a photograph of the PPI of a radar at Bedford Airport (sweep length about 50 miles), and on the right is a photograph of a PPI taken at the same time, showing the same video after passage through two 10,000-Mc/sec transmitters and two receivers.

7-12. Video Mapping.¹—The experienced radar operator often covers the indicator tube with marks that indicate the location of natural or man-made hazards and with temporary notations of flight tracks. He often works with a grease pencil in one hand and a cloth eraser in the other.

These markings can be put on the tube for him in advance by the use of video mapping. This is a method of applying information to the face of the indicator tube by inserting appropriate signals into the video channel. It is possible either to reproduce maps made in advance or to reproduce information of any type as it is being written upon the face of an indicator. The map may consist of a single dot or it may be a copy of a complicated chart. The minimum information is usually provided to avoid confusion and obliteration of important echoes. This information retains its value, regardless of expansion of the sweep or off-centering because it comes through the video channel and is inflexibly related at all times to the radar echoes in range and azimuth. The formal points of reference provided on standard radar indicators by range and azimuth marks possess no particular conveniences. A video map can be made to show the navigator the reference points he most wants to see, no more and no less.

General Principles.—The problem presented by video mapping is essentially one of rudimentary television. It is necessary to scan the desired map or indicator, to translate this information into video signals and present it on other indicators. The problem is simpler than that of ordinary television because no motion of the subject is involved. In other respects the requirements are equally severe and exacting. For example, accurate synchronization with the motion of the antenna and with the radial sweep of the indicator tube must be maintained. The video map must be accurately oriented with respect to the radar pattern.

The ideal video map would present desired information in the form of sharp distinct lines, equivalent to the sharpness of good range or angle marks. The ability to do this is limited by factors affecting each stage of the process—scanning, video transmission, and presentation. At the present time, there is room for improvement in this direction although it

¹ By R. H. Müller.

makes relatively little difference whether one is trying to bisect a large target image with a fine line, or to fit an echo to the center of a relatively broad map line. There is no question that a fine line is preferable because it is easier to align with reference points and is less likely to obscure faint echoes.

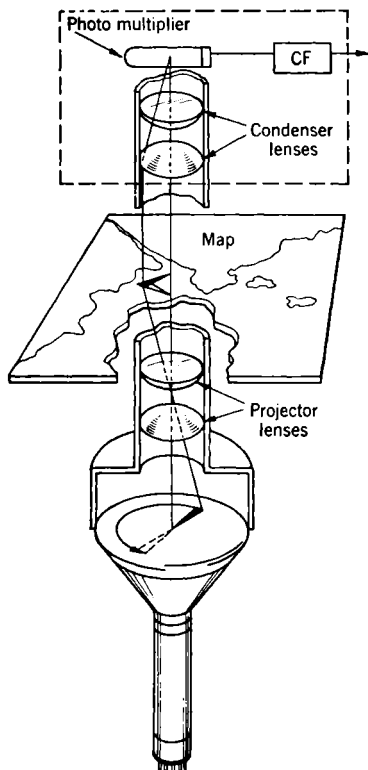

FIG. 7-50.—Schematic diagram of scanner for video mapping.

The essential elements for use in this type of video mapping are shown in Fig. 7-50. A photographic negative of the map is scanned by a cathode-ray tube that is used as a light source. A projecting lens system brings this light to a focus in the plane of the map. The light transmitted by the map is focused through a condensing lens system onto the cathode of a photomultiplier tube. The scanning process is the resultant of two motions; the radial sweep of the cathode-ray tube source is synchronized by the main trigger, and the repetition rate of the radar set and the azimuthal rotation of the sweep are synchronized with the motion of the radar antenna. In practice, the azimuthal rotation, although synchronized with the antenna motion, must be displaced by 180° because the projecting lens system inverts the image of the light source. The need for a linear sweep is evident. Linearity is best examined by scanning test patterns which consist of uniformly spaced concentric circles or rectangular coordinates.

Video-map information should be available to the scope operator at all times, and its presentation should not distract him. He should be

Reproduction of "Canned" Data.

The only field and tactical tests of video mapping made so far are those based upon a modification and adaptation of the Emerson trainer in which carefully prepared maps were reproduced. Other approaches, embodying considerable simplification and improvement, have been studied in the laboratory and will be described later. The Emerson trainer was designed to simulate the radar presentation that airborne radar equipment received from terrain or fixed targets.

The essential elements for use in this type of video mapping are shown in Fig. 7-50. A photographic negative of the map is scanned by a cathode-ray tube that is used as a light source. A projecting lens system brings this light to a focus in the plane of the map. The light transmitted by the map is focused through a condensing lens system onto the cathode of a photomultiplier tube. The scanning process is the resultant of two motions; the radial

able to switch the video-map information on or off and to vary its brightness. Since beacon responses will often be required, it has been found useful to install a small general-purpose video-mixer box on the console from which beacons, video mapping, and other information can be selected and controlled.

A map holder accommodates a standard 4- by 5-in. plate and is provided with a tangent screw for rotating the map about the optical axis. Two other screws at right angles permit a lateral shifting of the map roughly in the north-south or east-west direction. It is practical to include reference marks on the map itself and to align these with the appropriate range and azimuth marks on the CRT. If the plate holder is well-designed, the map may be replaced repeatedly without shifting the pattern on the scope.

Suitable map information has been produced in a number of ways, the adoption of any particular method depending entirely upon the purpose for which video mapping is being used. It is very important to decide whether speed or precision is desired. The photographic method would seem to be slow; actually it was found that the necessary operations could be accomplished in less than ten minutes.

Although standard photographic techniques can be used to photograph the maps, several special precautions must be taken in this preparation. The lines must be fine and show a high degree of contrast. Blooming will appear on the PPI if the intersections of lines are not broken. When a simple pattern is required, the scratch-plate technique is very useful. It consists of coating a clear glass plate with an alcoholic dispersion of colloidal graphite to which a plasticizer has been added. Very fine lines can be scratched on the opaque coating with a stylus; the degree of contrast so obtained is generally superior to the best high-contrast negatives. A precision pantograph might be used, but the scale reduction that is required is of the order of 20 to 1. It is very helpful to mark four spots at 90° intervals and preferably at different ranges to serve as orientation points.

A representative setup for video mapping is shown in Fig. 7-51. The converted Emerson trainer is at the left. The map carriage, with its adjusting screws, is above the glass table top and occupies the space between the two parts of the barrel containing the optical projection system. A light shield has been opened to show the accessibility of the map carriage. Only two of the controls, Tube Brilliance and Video Gain, on the front panel of the chassis, are concerned with video mapping.

At the right is a 12-in. off-center PPI. This is identical with the other PPI's and is simply used for monitoring. Suitable cables and junction boxes enable the operator to switch the desired video-mapping information on his own PPI and then to place the same information on

the scopes in the main operations room. At the upper left of the sloping PPI panel is a small box containing a sweep expander that enables the operator to make small adjustments in the video-map scale and to align reference points accurately with the range marks. Immediately above is the video mixer box with which the map signals can be switched on or off or changed in brilliancy. The large box to the right is a visual aid for the operator. It not only shows a large-scale version of the video map that is being presented on the scope, but it also contains boldly printed notations, names, and directions which are readily correlated with

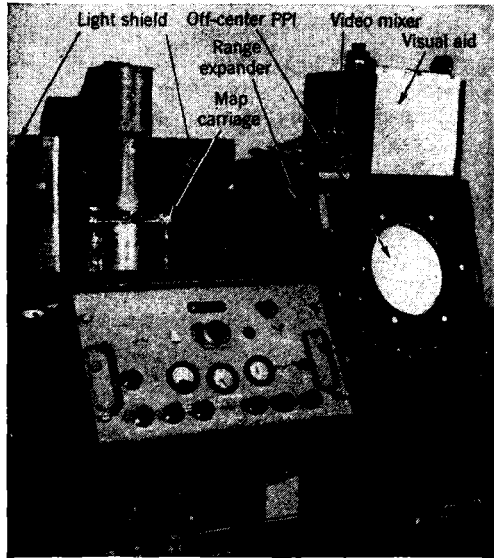

FIG. 7-51.—A typical video-mapping installation using a converted Emerson trainer.

the picture on the PPI. It is illuminated with filtered light that can be adjusted to the desired intensity.

The conventional communication facilities enable the operator to give the pilot directions after comparing the position of his airplane (indicated by radar signals) with the video map.

Applications.—Of the many conceivable applications of video mapping, a few which have been investigated may be described briefly.

In the delineation of flight paths a simple example is afforded where the locations of a dozen or more airports are indicated by circles, interconnected by straight lines. It is possible to follow many flights along these routes and to tell at a glance whether each airplane is on its proper course. It is equally easy to give corrections for minor course deviations, especially those that arise from cross winds or other effects not immedi-

ately evident to the pilot. As an example, Fig. 7-52 shows a number of paths over which pilots have been directed with great ease and convenience. Such a network of flight lines brings a degree of order to free-space navigation akin to the inflexibility of the railroad or motor highway.

Another way in which video mapping can be used as an aid to navigation is to help controllers identify check points to pilots. In Fig. 7-53 the map line, which runs roughly north-south and approximately 30 miles west of the radar site, represents a railroad, and lateral marks on this line indicate towns, crossings, rivers, and other distinctive landmarks. If an airplane is directed over this course, it is easy for the controller to identify each landmark for the pilot as he passes over it. A conducted travelog of this sort is rather startling to a pilot, especially if he is not aware of the simple means used to furnish him with this information.

Video mapping can assist in the air-traffic control problem by feeding aircraft into the GCA system from great distances, after which GCA properly takes over the landing operation. Referring again to Fig. 7-53 the crossed pattern at 47 miles and 243° azimuth indicates the location

of an airport. The small dot near the intersection of this pattern represents an airplane that has been brought by video mapping to within half a mile of the field. Figure 7-54 is an aerial photograph taken from this airplane at 8000 ft showing an approach to the same airport specifically aimed at the north-south runway. Because of a minute error in map alignment, the approach is about three quarters of a mile east of the runway. This would be of no consequence if local GCA precision equipment were taking over control at that point.

Frequently the operator of a search radar has to designate the location of aircraft to other operators. It is convenient to use video mapping for this purpose. The polar coordinates (range and azimuth marks) of the remote station are presented as a video map on the search-radar

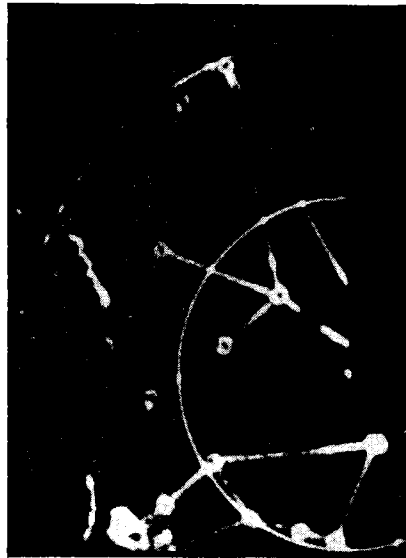

FIG. 7-52.—Delineation of flight paths by video mapping. Several airports are represented by circles that are interconnected by straight lines. Range circles are shown at 50 and 150 miles.

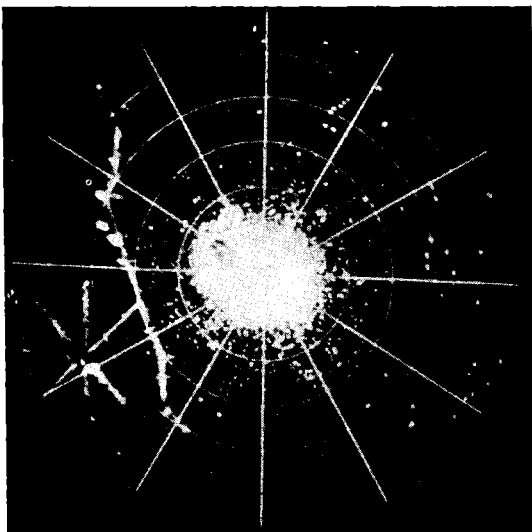

FIG. 7-53.—Check-point designation and application to GCA. Irregular line represents a railroad with identifying marks along its course. Cross pattern to the left defines location and approaches to an airport. Note profusion of echoes from airplanes.

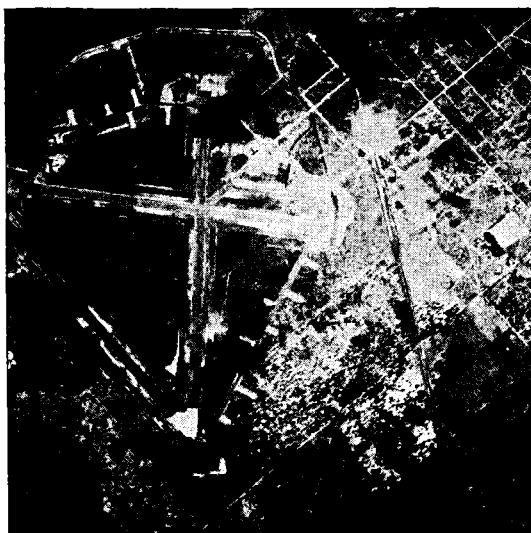

FIG. 7-54.—Aerial photograph from 8000 ft confirming the accuracy of an approach directed with the aid of video mapping. Precision blind-landing equipment at the airport would take over before this stage of the approach was reached.

indicator. Airplane echoes are now reported to the remote station directly in terms of its own PPI coordinates. Tests have shown that this method saves much time, especially with rapidly moving aircraft.

Precision.—The present limitations in producing fine lines by this method are best evaluated by reference to Fig. 7-55. A point 70 miles from the radar site has been designated by the intersection of two straight

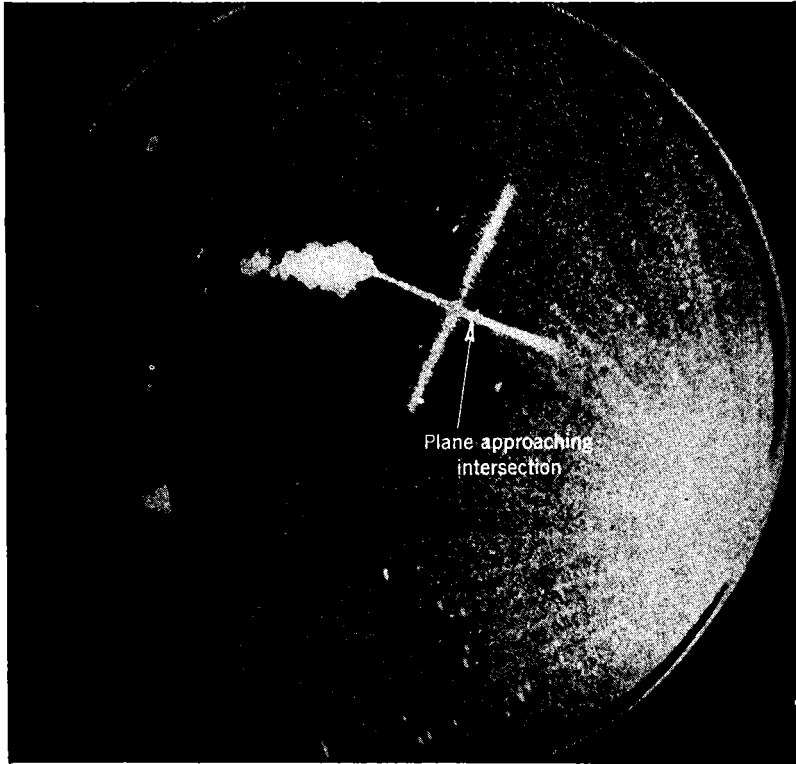

FIG. 7-55.—Designation of point by intersection of two straight lines, 70-mile range with off-centered presentation.

lines. This appears on the scope, with an off-centering of about 1.5 radii and the most distant end terminating at a thunderhead. The echo from a four-engine airplane is approaching the intersection along a designated heading of about 304° . Since the echo itself is relatively broad there is no particular handicap in the considerable width of the video-map line.

Figures 7-56a and 7-56b show a more complex pattern, also at a range of 70 miles. In Fig. 7-56a an airplane is approaching the intersection

from the northeast. In Fig. 7-56b it is over the intersection. This airplane was repeatedly directed to this intersection, each time from a different direction. Its average distance at nearest approach was 245 yd. Each approach was approximately 20 miles in length. It was apparent from the vectoring information given to the pilot along different legs that a considerable wind-drift correction was necessary. The video-map line is helpful in estimating wind direction and magnitude.

Reproduction of Live Data.—Some of the severe limitations imposed on video mapping by the use of an Emerson trainer can be avoided by methods that permit the scanning of larger map diagrams. One of these

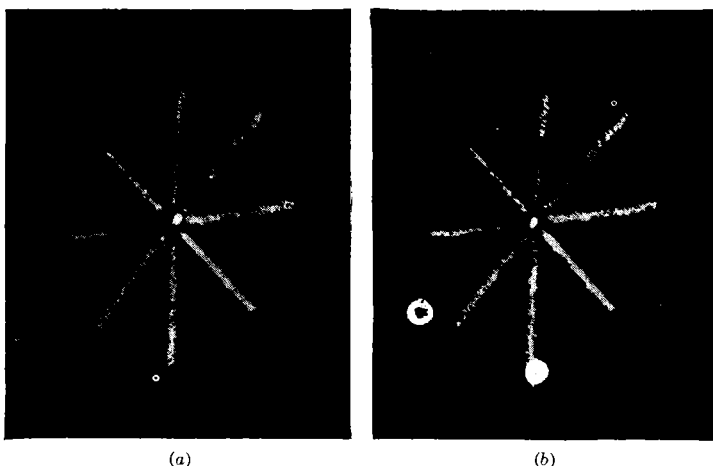

FIG. 7-56.—Airplane destination designated by cross pattern, range 70 miles. (a) Airplane approaching destination from northeast; (b) airplane is now over destination.

uses a 12-in. PPI as the light source.¹ The map is drawn directly on the tube face or a photographic negative is placed directly in front of it. No optical system is used, but a photomultiplier tube must be placed at a distance of about 75 cm.

The simplicity of this arrangement, shown in Fig. 7-57, is very attractive. Because the reproduction is almost instantaneous, this technique is a very promising aid in the air-traffic control problem.

The map surface is sufficiently near the screen material so that resolution is not noticeably decreased, and the variations in light intensity are picked up directly by the collector, a photomultiplier tube. This simple arrangement is made possible by the short persistence of the blue flash on a 12DP7 tube, and the relatively low sensitivity of a RCA 931A

¹ J. Hexem, "Video Mapping," RL Report, January 26, 1946.

photomultiplier tube to the yellow persistence of the screen combined with its high sensitivity to blue light.

The mapping signals may be obtained by two different methods which will be referred to as "positive" or "negative" data take-off. Either method may be used with the various limitations mentioned below.

Negative data take-off applies when the field is opaque and lines are transparent; the signals are obtained by transmission of light from the scanning beam through the transparent lines, as shown in Fig. 7-58.

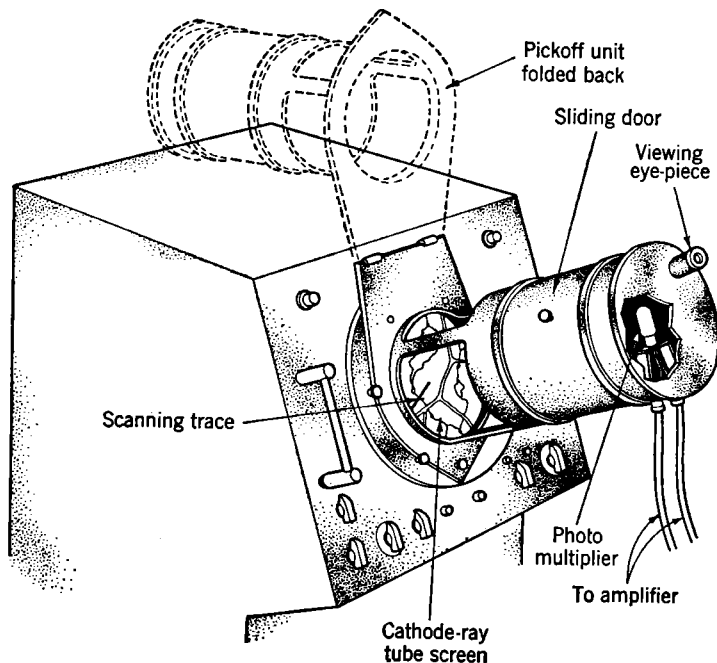

Fig. 7-57.—Equipment for video mapping by direct scanning on the tube face.

Figures 7-58*b*, *c*, and *d* show reproductions of this type of field on remote indicators. The sweeps on the scanning indicator may be off-centered or delayed, as desired, and no particular precautions in amplifying the video signals need be observed. But the opaque mapping surface precludes the possibility of using this method for plotting. A yellow-filter surface with data lines made by removing the surface might conceivably be used.

In positive data take-off the scanning tube face (or data plate) is clear, lines are opaque as shown in Fig. 7-59, and signals are obtained by interruption of the scanning beam. Figures 7-59*b*, *c*, and *d* show the map

as viewed on a second indicator. This method appears to be more flexible operationally than that outlined above but the handling of the signals from the photocell is somewhat more complicated.

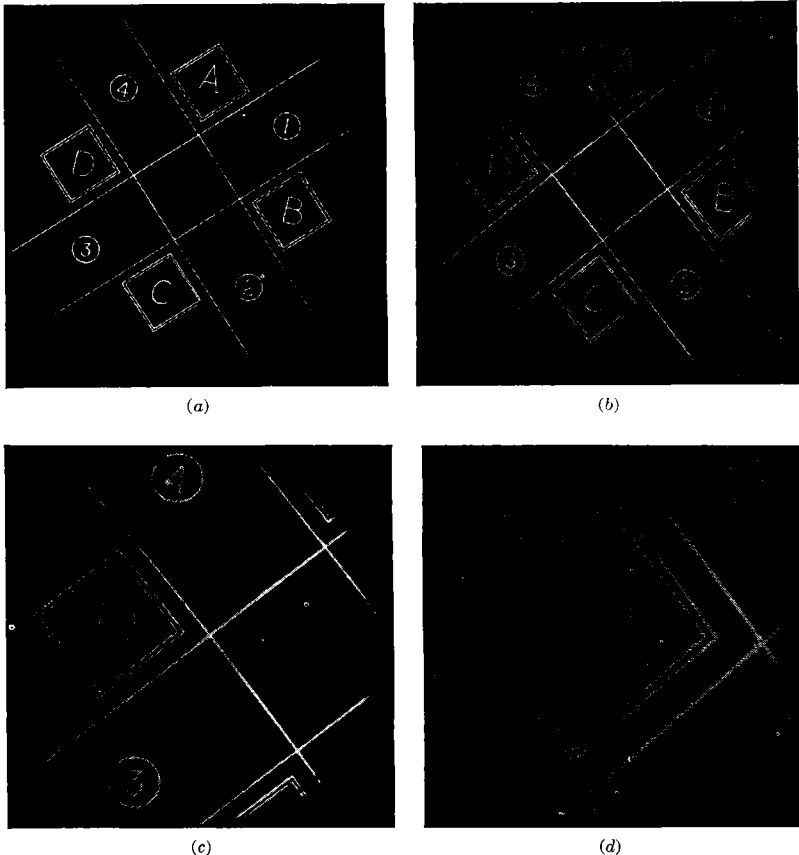

FIG. 7-58.—Method employing negative data take-off; 150-mile sweep on scanner. (a) Scanning scope. (b) Image on repeater scope without magnification. (c) Image on repeater scope, 2 to 1 magnification, off-centered. (d) Image on repeater scope, 4 to 1 magnification, off-centered.

Two methods have been used successfully to overcome technical difficulties. In one of these the video is differentiated and the boundary of the mapped area is then surrounded by a circle; only the leading edges of extensive signals will appear and radial map lines must be dotted in order to be seen. The scanning scope can be off-centered or delayed at will. In the second method the video is gated and the solution is easy

if the scanning scope is operated "on-center." Even so, undue complications arise only when a rotating coil PPI is used.

The degree of success that can be attained in overcoming these difficulties is evident from a comparison of the photographs made in the

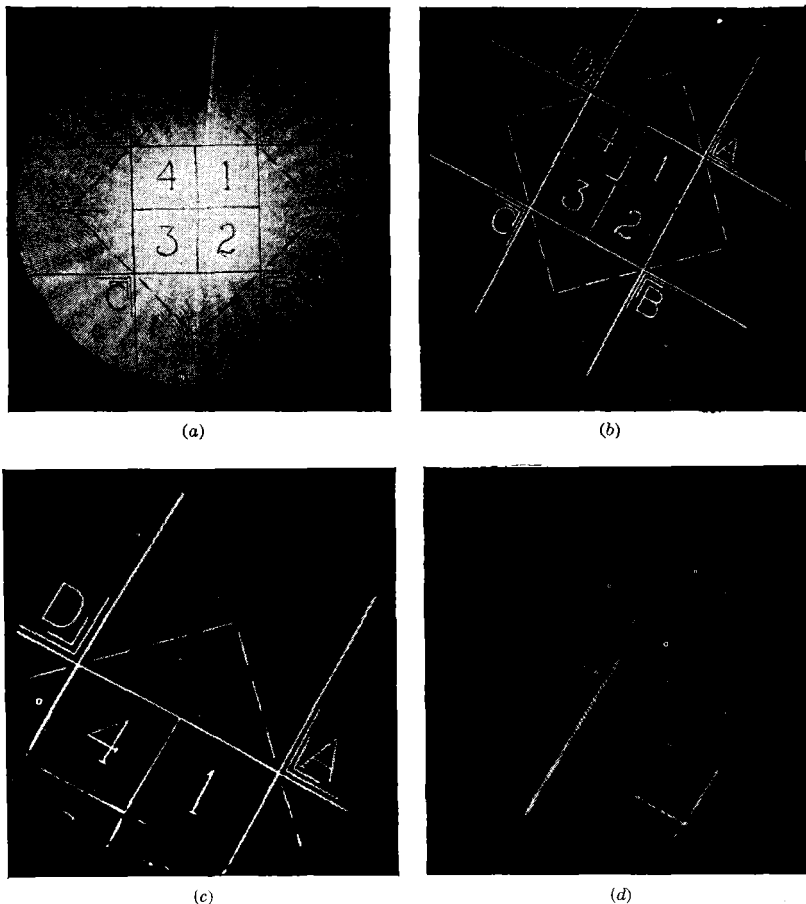

FIG. 7-59.—Method employing positive data take-off; 150-mile sweep on scanner. (a) Scanning scope. (b) Image on repeater scope without magnification. (c) Image on repeater scope, 2 to 1 magnification, off-centered. (d) Image on repeater scope, 4 to 1 magnification, off-centered.

laboratory. There is no reason to believe that equally clear reproduction cannot be achieved in the field; the accuracy has not yet been determined.

With this positive data take-off system, it is possible to calibrate mapped data against range and azimuth marks or against permanent

echoes from radar return. Alterations or additions in map data can be made easily with a reasonably sharp black grease pencil. The CRT can still be used for other operations and it is possible to share time between radar and mapping signals. In this way, a plotting procedure can be set up so that track progress and identification can be transmitted to other indicators. Such a time-sharing procedure can be based on sharing either recurrence periods or azimuth scan cycles.

A disadvantage common to all these methods is that the intensity of the CRT trace must be increased for the map-scanning period. The yellow afterglow layer is strongly excited and tends to obscure regular radar return during its share of time. The recurrence-period sharing technique seemed promising, but insufficient work was done to guarantee the results.

The photocell pickoff and stovepipe assembly unit shown in Fig. 7-57 was designed to fit a PPI indicator. A sliding door is incorporated to provide access to the face of the CRT when the unit is in operation. The unit is so hinged that it may be swung away from the indicator when not in use.

The electrical components include the photomultiplier and a cathode follower to drive a low-impedance line to the video amplifier which is located elsewhere. This amplifier was designed to accept either the output of a positive or negative data take-off system.

In summarizing, it should be added that electromechanical scanning systems are not ruled out although synchronization would be difficult. Likewise,¹ the iconoscope and orthicon still remain as interesting possibilities.

It is likely that precision and the general convenience of operation will be the most important factors in determining the usefulness of video mapping. In some applications the time involved in preparing maps would be of no consequence; a library of video maps, any one of which could be selected and used at a moment's notice, would be at hand. In other applications, it might be advantageous to draw and present a video map or instructions on the face of the tube for immediate transmission to a remote indicator.

7-13. Radar Aids to Mapping.¹—A good map is often the best aid to navigation. It is fitting, therefore, to discuss how radar can indirectly help the navigator by facilitating the construction of accurate maps.

Present Methods.—The latitude and longitude of any point on the surface of the earth are determined by astronomical observations. The positions of a number of points can be combined into a common network by trigonometric surveys. This process increases the accuracy of the position of each point with respect to the mean position of the network. The fundamental point of "North American Datum" is on Meades'

¹ By J. S. Hall.

Ranch, Kansas, and its assumed coordinates are given to 0.1 ft. Such surveys are made in this country by government agencies including, principally, the United States Coast and Geodetic Survey and the United States Geological Survey.

The *astronomical* position of any point can be determined with a probable error of $\pm 1''$ or smaller with an astrolabe. This angle corresponds to 100 ft in the horizontal plane. Each astronomical position so obtained must be corrected for the earth's figure and for local aberrations of the plumb line caused by uneven terrain before it can be converted to *geographical* position. This correction is the so-called "station error." Station errors determined on the west coast vary from about $10''$ to $20''$ and can be estimated to about $1''$ or less. The combination of an ocean and a mountain, however, produce a station error estimated to be $64''$ at the southern end of Hawaii. The uncertainty of this value is several seconds of arc.

After the accurate position of a large number of control points on the surface of the earth has been established by a combination of astronomical observations and trigonometric surveys, the use of aerial photographic methods (photogrammetry) permits accurate mapping at a very much reduced cost as compared to classical methods. Photogrammetry has recently come into extensive use; about one quarter of the land surface of the earth has been photographed from the air. Although most aerial photographic mapping relies on vertical or nearly vertical photography, a considerable amount of experimental work has been done with oblique photography that permits fair accuracy over a much larger area; about 100 square miles can be mapped in this way on a single exposure. The details of either method are beyond the scope of this book. We are most interested in discussing how radar techniques can rapidly increase the number of control points, upon which accurate photogrammetry depends.

Because the angular accuracy obtainable with radar is much less than that obtainable with much simpler equipment such as a theodolite, the use of radar should be confined to the measurement of range.

Short Range Measurements.—Several radar systems capable of accurate measurement were developed during the war. Calibration tests conducted by expert personnel on an especially tailored SCR-584 system indicated that ranges up to 10 miles could be measured to 10 or 15 ft. There is no reason to believe that this same accuracy would not hold up to ranges of 100 miles or more. The precision with which range can be measured by these techniques decreases very slowly with range. The precision of range measurements made by trigonometric surveys decreases at a rate proportional to the range. The SCR-584 was a gun-laying set and obviously not practical for solving problems of this sort. A light-weight radar called the Handy Radar which has similar ranging circuits is shown in Fig. 7-60.

Target identification presents a very important problem in accurate radar ranging. Since radar beams are often a degree or so wide, a specific point of interest must be identified. The best way of doing this is to place a radar beacon at that point to receive each pulse and after a fixed delay of 1 or 2 μsec , to transmit another pulse at a different frequency.

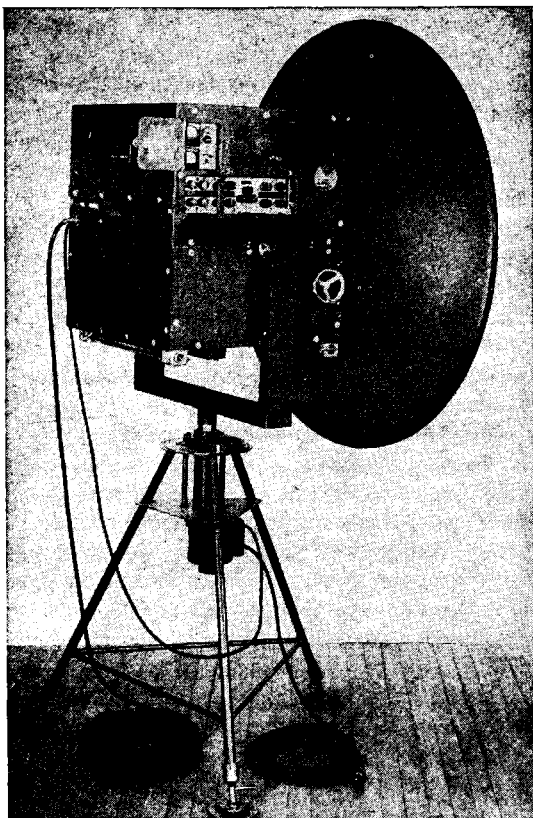

Fig. 7-60.—The Handy Radar. A complete 10-cm system with a 4-ft reflector. Weight, 250 lb. Power required, 1500 watts.

In this way only beacon signals would be presented on the A-scope. The difficulty here involves the measurement of the delay time of the beacon; since radio waves travel $984 \text{ ft}/\mu\text{sec}$ either this delay must be carefully monitored at the beacon or an extremely reliable beacon must be used.¹

¹ As an alternative, a flat metallic reflector could be placed at the desired point. If this plate were carefully oriented by means of a transit in such a manner that the

The accuracy with which range can be determined by ground-based radars with present equipment over ranges of 10 to 50 miles is somewhat less than that obtainable by direct trigonometric surveys using angular methods. When distances of one hundred miles or more are measured, radar techniques may be extremely useful. In order to achieve a long

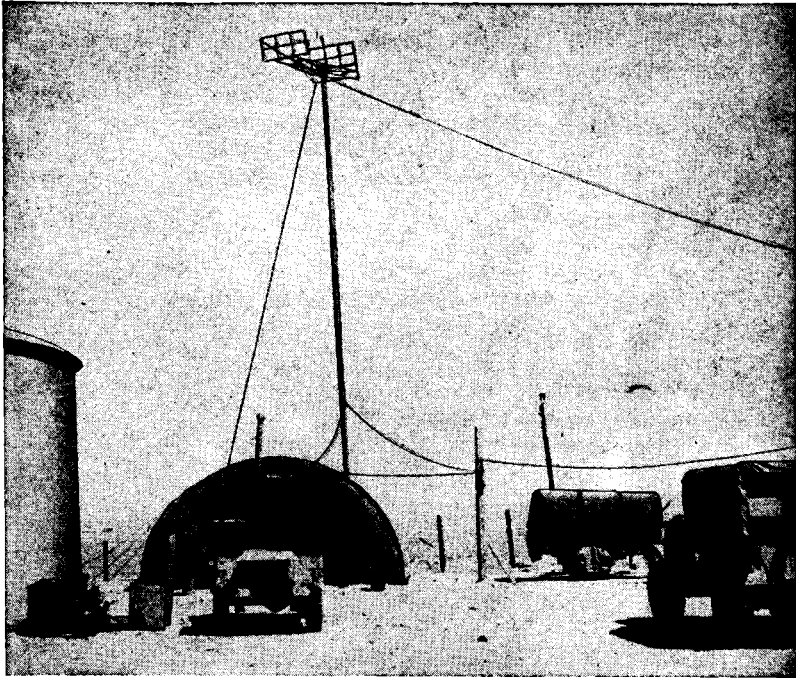

FIG. 7-61.—Shoran ground station showing the power generator, antenna, and tent housing the beacon and communication equipment. (Courtesy of the United States Army Air Force.)

line of sight the interrogating equipment must be carried in an airplane and flown in such a way as to determine the ranges of beacons situated at control points on the ground. Shoran (devised by RCA) has been used for this purpose. A typical ground station is shown in Fig. 7-61.

Shoran.—The airborne equipment consists of a transmitter for interrogating two ground-based beacons and a range circuit for accurately measuring the time that it takes the pulses to make the round trip. The two beacons are alternately interrogated on different frequencies and the

radio wavefront would strike it normally a strong signal would result. This eliminates the necessity for measuring the signal delay, but there is some question as to whether such a plate would give a signal strong enough to be distinguished from ground clutter. The use of corners reflectors (Sec. 9-4) should also be considered.

range is indicated continuously on dials by methods of aided tracking. The method described here has been developed largely under the direction of Lt. Col. Carl Aslakson of the 7th Geodetic Control Squadron. Col. Aslakson, a commander in the United States Coast and Geodetic Survey,

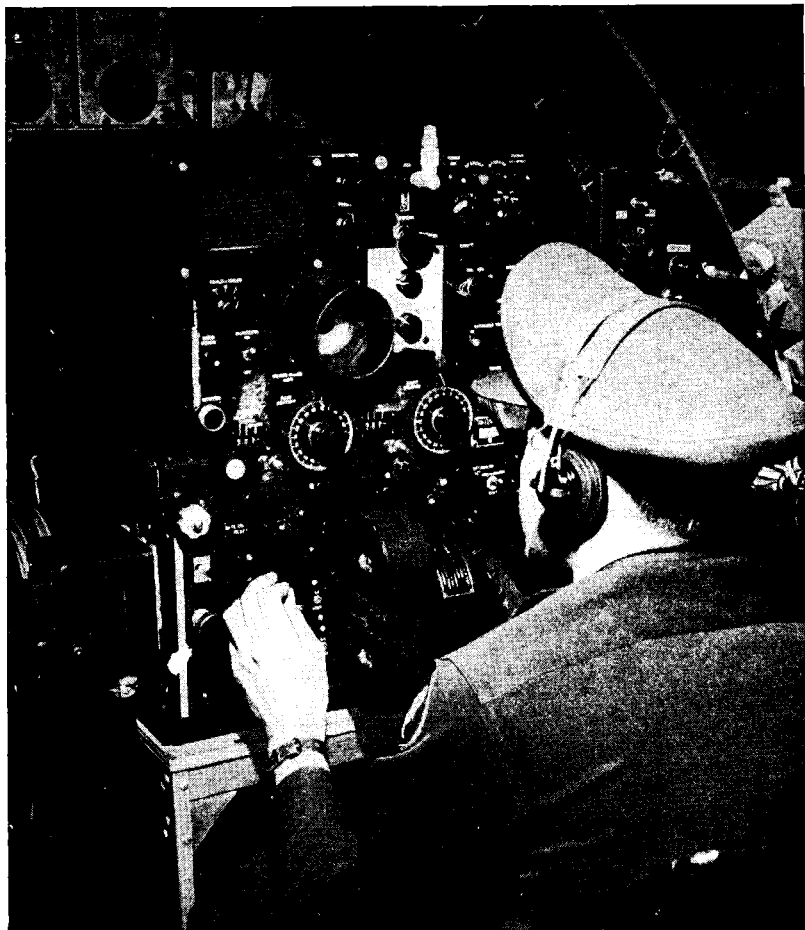

FIG. 7-62.—Shoran equipment, airborne station. (Courtesy of the United States Army Air Force.)

is also the Shoran expert of the 311th Reconnaissance Wing, AAF, Buckley Field, Colorado.

When this method is used for determining the geodetic distance between two points, the airplane approaches the mid-point of the line

between them at right angles. When the sum of the two measured distances is a minimum, the airplane will be directly over this line. In order to facilitate the recording of the data a 35-mm camera is installed in front of the panel board and pictures are taken automatically every 3 sec. The Shoran operator must keep signals properly aligned on a cathode-ray tube while these measurements are being made. When the

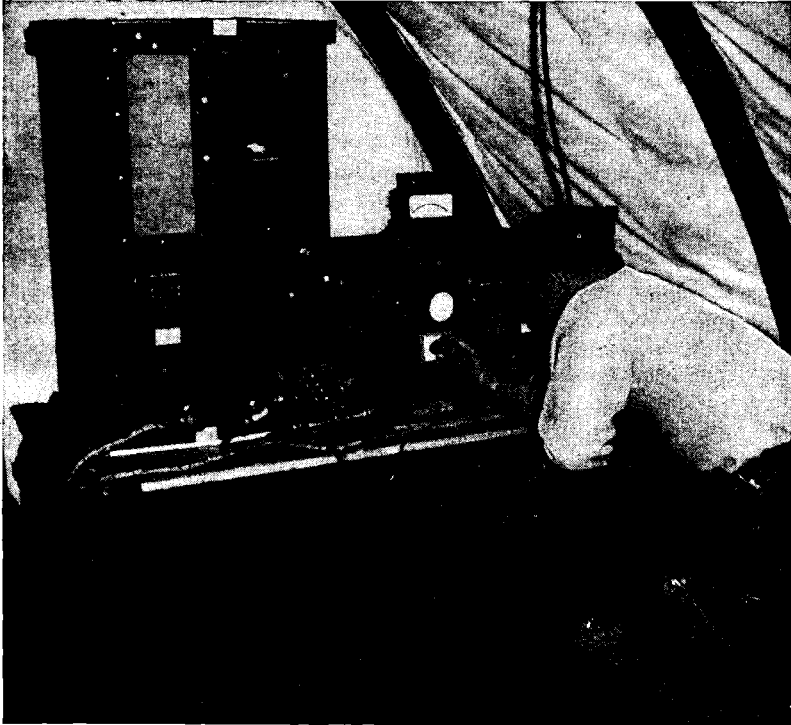

FIG. 7-63.—Shoran equipment, ground station. (Courtesy of United States Army Air Force.)

sum of the observed distances is plotted against the time of each exposure, the points lie along a curve which for practical purposes may be assumed to be a parabola. The most probable minimum value for the sum of the ranges is then computed by the method of least squares. This distance then must be corrected for atmosphere refraction, altitude of the airplane, altitude of the beacons, etc. The airborne and ground-based equipment is shown in Figs. 7-62 and 7-63.

In order to ascertain just how accurately Shoran measures range, the United States Coast and Geodetic Survey was asked to determine the geodetic positions of points at Pikes Peak and La Junta, Colo.; Cheyenne,

Wyo.; Imperial, Neb.; and Garden City, Kan. Ground stations were erected at these points and the lines between them were flown many times with Shoran-equipped airplanes. The average of all line crossings made in the experimental area with rather crude equipment indicated an error of 1 ft in 33,000. This compares favorably with the permissible error of 1 part in 25,000 in first-order control work in geodetic surveys. The accuracy covered a wide range. For example, the error in the Pikes Peak—La Junta line was 1 ft in 6000 (comparable to third-order work) whereas the error in the Cheyenne—Garden City line was only 1 ft in 150,000. It is expected that new and improved installations will increase this accuracy.

The accurate position of a third point may be determined by measuring the distance between two known positions and that of the unknown using similar procedures. If this process were continued, it is estimated that a control network for the entire world could be extended from a base line no longer than Florida. The length of line that can be measured by the Shoran method depends on the maximum altitude that the airplane can fly and on the elevation above sea level of the two points involved. Distances between points 400 and 500 miles apart can be directly measured.

The accuracy obtainable by Shoran is of the same order as that with which the velocity of light is known. There is no reason to suspect that this differs from the velocity of radio waves. Comparison between the results of angular- and direct-ranging methods of measuring distance may lead to a better determination of the velocity of radio waves.

This method appears to be a very promising one for determining positions of numerous control points throughout the world. The spaces between these points can then be accurately filled in by photogrammetry.

CHAPTER 8

RADAR AIDS TO AIR NAVIGATION AND TRAFFIC CONTROL

BY G. C. COMSTOCK, J. H. BUCK, M. A. CHAFFEE, AND J. S. HALL

8-1. Statement of the Problem.¹—When the air age was in its infancy, the navigational problems that faced a pilot were taking off, piloting, and landing his airplane. As long as he chose a clear day for flying so that his visibility was comparatively unrestricted, he could navigate in reasonable safety with almost complete disregard of other aircraft.

The necessity of flying at night or in unfavorable weather, and therefore under conditions of poor visibility, required the addition of instruments like altimeters, gyrocompasses, and artificial horizons, and of other ground and airborne aids, such as radio ranges, radio compasses, and optical and radio beacons. When combined with dead reckoning, these aids ensured reasonably reliable point-to-point navigation. The probabilities of safe arrival were increased when, more recently, landing aids like localizers, glide paths, and fan markers were installed.

Vast progress still needs to be made, nevertheless, in providing navigational aids that are accurate, flexible, and reliable enough to enable the pilot to navigate as freely and precisely by instruments as by visual contact. Fog, snow, and thunderstorms either must be made "transparent" or avoided. Night must be made, so to speak, as clear as day. An adequate collision-warning device which will eliminate the hazards of flying over mountainous terrain must be provided. Airplanes must not become lost nor be allowed to stray. Better instrument navigation must be achieved so that the single airplane can fly in all weather.

As the air age has grown into boisterous adolescence, the increased number of airplanes in the air has hampered free flight from point to point. Safety has been sharply reduced, departure often delayed, and travel time greatly increased. The situation under instrument flying conditions is now so deplorable that despite all the existing navigational aids and the ability of the pilot to use them, purposeful air travel has dwindled to a surprisingly small fraction of good-weather flying. The air traffic problem has become the major one in navigation, seriously threatening the further growth of air travel.

Although the problem is one of efficient maintenance of a smooth traffic flow when flights must be made either completely or partly on

¹ By G. C. Comstock.

instruments, a traffic problem also exists under contact conditions, particularly where traffic is dense, as at an airport.

A completely self-regulatory system does not appear to be feasible. In addition to the traffic rules that are now in force, external traffic-control devices to aid in maintaining a safe and efficient flow and to provide surveillance over possible infringements of the rules must be devised. Because the amount and severity of control needed depends on the density of the traffic, the control required in "instrument weather" in the approach zone surrounding one or several airports is likely to be much more severe than elsewhere.

Because it is desirable to use as many of the same navigational aids as possible both for pilotage and for the air-traffic control system, these problems should be considered together. A combined air-navigation and traffic-control system would appear to be the ideal solution. Little thought is now being given to such an over-all system, nor is there as yet (Spring, 1946) any general agreement among the users of air equipment, the agencies now responsible for traffic regulations, and the equipment manufacturers, as to the basic principles which should underlie such a system.

Some feel that the over-all system must be flexible enough for use in both contact and instrument flying conditions. Many feel that it must be introduced gradually, both in the sequence of installation of the equipment and in the complexity appropriate to various densities of traffic and various types of users such as transport airplanes, military aircraft, and private airplanes.

There is sharp disagreement over the distribution of the traffic-control function between the pilot and the external ground agency. One group believes that the airplane crew should be given navigational and control information that is sufficiently reliable and easy to interpret for the flight plan to be carried out with minimum reference to the ground agency. The information is transmitted through a combination of airborne and ground equipment and as far as possible, should be obtained and conveyed automatically. Surveillance would be left to the ground personnel who monitor operations in the control area and take control through direct communications when the traffic plan is violated. The pilot, however, must be given opportunity to obtain clearance for altering the flight when emergencies arise.

Others agree that such a system is feasible, but only in areas of very dense traffic; still others emphasize the need for the human brain rather than an automatic device to be dominant in the control system. Many who disagree completely with the idea of sharing control between air and ground argue that the cockpit should be furnished with so complete a picture of the traffic situation that the pilot can maneuver his airplane

with at least the same degree of safety and efficiency achieved in contact flying today without any reference to ground agencies whatsoever.

Obviously, if progress is to be made in establishing any portion of an over-all system some agreement must be reached. Each philosophy, therefore, must be examined, in the light of various traffic situations, as to the limitations to efficient flow of traffic and to safety of aircraft inherent in each. This calls for coordinated analytical thinking by all parties concerned, a program of experimental tests, and agreement as to the implications of the data obtained.

For all of these reasons, no attempt is made here to propose a complete navigational and traffic system based primarily on information obtained by radar methods. Radar, through its ability to provide in any weather continuous accurate information as to a pilot's position with respect to a desired course, his proximity to other aircraft and ground obstacles, and miscellaneous meteorological information, provides a new tool which should help to meet the equipment demands of whatever plan is adopted. Radar methods can supply only a fraction of the required information, however, and do that effectively only if integrated with all the other aids.

The remainder of this section is a review of the present system of air navigation and traffic control and its shortcomings in instrument weather. The next section discusses the contributions that various radar aids can be expected to make in providing navigational and control information under various general system philosophies.

Present Traffic-Control System.—The air-traffic control system developed in the United States during the past 20 years is now administered by the Civil Aeronautics Administration, CAA, through the Department of Commerce. Among its functions are the establishment of rules and regulations for civil air traffic; establishment, operation, and maintenance of federal airways including installation of radio ranges, fan markers, ground communication facilities, instrument landing aids, etc.; establishment of airway control centers; and, during the war, the operation of the major airport control towers. Usually airports and their control towers are owned municipally or privately and are operated under CAA supervision.

A detailed discussion of the difficulties of maintaining efficient and safe air-traffic flow is found in the authoritative "Air Traffic Control" (1945) by G. A. Gilbert and in the many publications of the CAA. In general, the CAA provides two kinds of service, ground navigational aids and traffic control. The navigational aids are available in all kinds of weather, 24 hours a day. Air-traffic control ensures safe and efficient traffic flow when the pilot is unable to proceed safely or expeditiously by himself, that is, under conditions of reduced visibility and in heavy air traffic.

The air-traffic rules of the Civil Air Regulations recognize two kinds of flight conditions: clear-weather flying under contact flight rules, CFR, and bad-weather flying under instrument flight rules, IFR.

Under CFR, it is the pilot's responsibility to avoid collision. He is subject to only a few instructions for expediting traffic at or near airports. Under IFR, the pilot flies by instruments, follows an established flight plan along controlled airways and is also subject to ground-control instructions. By setting up regulations concerning his position in relation to other aircraft, the instrument flight rules attempt to protect him from collision and at the same time to maintain an uninterrupted flow of traffic.

Let us enumerate briefly the traffic-control and navigational aids provided for enroute flying, in the approach zone surrounding the airport, and at the airport itself.

The United States is crisscrossed by a series of controlled airways outlined primarily by optical beacons and low-frequency radio ranges supplemented by fan markers, compass-locator stations, and communication facilities. These provide paths over which the pilot can navigate from point to point. A series of radio fixes over range stations, intersecting ranges, and fan markers give positional checks. Movements of aircraft along these airways are supervised by about 25 air-traffic control centers located in or near the major airports of the United States.

Each center controls all IFR air traffic within its specified area. Each area is subdivided into sectors, the size of which is determined by the maximum amount of traffic which the personnel can handle and by the minimum area which permits sufficient time for analysis and issuance of instructions.

The functions of the centers are as follows:

1. To issue traffic-control instructions and information to aircraft flying along the civil airways for the purpose of preventing collisions when visibility is low.
2. To provide a well-regulated and fast-moving flow of air traffic during unfavorable weather conditions.
3. To warn pilots of hazardous weather conditions and supply information concerning suitable alternate airports or other changes in flight plan.
4. To check periodically on all aircraft for which flight plans have been filed and to initiate action for locating overdue aircraft.
5. To report accidents occurring on a flight plan and to provide the fullest possible assistance to aircraft known to be in difficulty.

The heart of each air-traffic control center is a series of flight progress boards, one for each range station or other positional fix in the control

area. A number of controllers keep a continuous record of the path of each airplane through the region by posting such flight information as the expected departure time, estimated times over various fixes enroute, reported time over the fix, altitude at which the airplane has been cleared, etc. This information is obtained from the flight plan, positional reports from the pilot, and estimates from other air center personnel. The airway controllers, by examining the posted data and applying the instrument flight rules, approve flight plans, issue instructions to airplanes enroute confirming or altering flight plans, etc. All such messages are relayed to the pilot. In commercial air traffic, there is no direct radio communication between the pilot and the control center. All information is relayed to the center on interphone or teletype by the radio station of the air carrier which maintains contact with its own aircraft. In noncommercial air traffic the pilot communicates indirectly with the control center through radio range stations.

Because the only actual positional data available to the center are the departure times and times over fixes (generally 70 to 100 miles, that is, 20 to 30 min, apart) the method of control must be mostly by prediction based on extrapolation of the data. These extrapolated data are often meager and inaccurate; consequently, the aircraft is assigned an airspace whose dimensions during smooth flow of traffic are 10-min flying time in length, 1000 ft high, and one-half the width of the airway. In other words, each aircraft has an airspace 30 miles long, 5 miles wide, and 1000 ft high assigned for its exclusive use at any given time.

When the numerous maneuvers, such as climbing and descending, the crossing of other airways, and the various and varying speeds of aircraft are considered, it is seen that the assembling of the flight progress data and the issuance of control instructions is an extremely complicated, four-dimensional process requiring the perfect coordination of a number of controllers in order to arrive at unconflicting decisions. Furthermore, as traffic density increases, it can be shown that the work load of the center increases at a rate at least proportional to the square of the number of aircraft handled; as more controllers are added to cope with the increased work load, the intercoordination required becomes excessive. Hence, there appears to be a saturation point that ultimately limits the traffic-handling capabilities of this type of control. Judging by the number of flight cancellations and delays in certain congested control areas during very bad weather, this saturation point appears to have been reached already at a level of traffic flow much less than the normal CFR flow and several times below what will be desired in a few years hence.

The present airport traffic control is needed primarily because of the density of traffic rather than because of weather. Its major function is a CFR function; it is to issue instruction and information in order to

prevent collision of taxiing aircraft and of aircraft taking off or landing, or approaching for a landing. It offers information on field conditions, warns pilots of improper functioning of their aircraft, relays control messages, weather information, etc. Controllers at an airport are concerned only with the aircraft they can see, with which they establish direct contact either by radio or by signal light.

As the visibility and ceiling around an airport drop, knowledge at the control tower of the immediate situation becomes increasingly meager and coordination of activity with the traffic-control center becomes increasingly necessary. The tower maintains control over traffic taxiing on the ground and over any visible airborne traffic. Take-off clearance must be obtained through the air-traffic control center and relayed to the airplane. Unless the tower has been specifically designated to control IFR traffic in the airport region (approach control), the control of the airplanes from take-off until contact before landing is under the jurisdiction of the airway control centers.

In this connection, a note on the standard method of instrument approach still generally used in this country is informative. The radio range serves as the standard navigational aid for instrument approach except at a few airports, at which the CAA localizer—glide-path instrument landing systems have been installed. In general, one leg of the range lies across the airport in line with the landing strip that is best for use under instrument conditions. A standard instrument approach is pictured in Fig. 8-1. The pilot flies toward the range station at the minimum instrument altitude (at least 1600 ft), crosses the zone of silence, and proceeds on course away from the range station, maintaining altitude for four minutes. He then makes a 180° procedure turn, heads back toward the field, crosses the zone of silence over the field at 800 to 1000 ft, and continues descent to the minimum letdown altitude (500 to 800 ft, depending on the terrain). If the pilot breaks through upon reaching this altitude he lands visually; if not, he pulls up. If an instrument-landing runway localizer is available, the minimum ceiling can generally be reduced by a factor of 2. This approach procedure takes 12 to 15 minutes, and, because the exact position of the airplane in this path is not known to the traffic-control center, only one airplane at a time is cleared to land until it has made contact and is under control of the tower. Holding stacks over fixes becomes common in instrument weather when traffic piles up because of the landing rate of only four to five aircraft per hour. These stacks are normally under the control of the airways center as is the aircraft throughout the letdown procedure. Only upon break-through is the pilot cleared to the tower.

When CAA took over operation of a number of major airport towers during the war, it instituted a system of approach control by which

certain towers were given the IFR control of aircraft at the holding fix, and the subsequent control was done by the tower through direct radio contact. In addition to this, the holding fix was made a fan marker on the approach range leg in some instances and the approach procedure was considerably shortened in time by making straight-in approaches over the range station from the holding fix. By authorizing succeeding airplanes to leave the holding fix at specified intervals, it has sometimes been possible to shorten the time intervals between aircraft landings to from 5 to 8 min.

A third method of approach control, called "ADF" approach control, is under test (Spring 1946) at La Guardia Airport, New York. This and

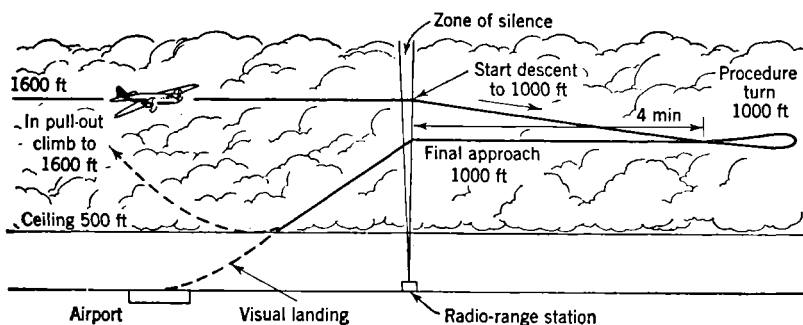

Fig. 8.1.—Standard instrument approach for radio-range letdown procedure.

other methods of approach control also being tried utilize the present fix information.

It is clear that at the present time the major bottleneck to traffic flow in IFR conditions lies in the inadequacy of the airport traffic-control procedures and instrument-landing facilities.

Limitations of the Present System.—In summarizing a few of the limitations to the present systems it should be noted that many of these have been pointed out by CAA, Army and Navy, and air-line personnel for years. Some of the deficiencies will be alleviated with the installation of the proposed CAA vhf improvements. Others require radical changes.

In enroute flying, the major limitations are:

1. The airways are outlined by two course ranges in inflexible fixed lines of flight which take no account of weather hazards, unusual traffic-density conditions, and emergency failures; they often require considerable lengthening of flight paths between designated points.
2. Low-frequency ranges are not entirely reliable; they are subject to night effects and swinging of the course over uneven terrain and are susceptible to interference by static.

3. Reported positional information as determined by the pilot from dead reckoning, altimeter setting, and range fix data is not sufficiently accurate to prevent collision with other aircraft, particularly unreported aircraft.
4. No warning for preventing collision with terrain can be given.
5. Conflicting decisions result when the work load of normal data coordination at the airway control center becomes excessive because of heavy traffic density.
6. The entire airplane-to-ground communication procedure of reporting position and control information is complicated by the number of messages sent, delays encountered, and inaccuracies transmitted.
7. The entire control procedure permits human failure on the ground without the pilot's being aware of it. Also, because the ground station possesses no direct evidence that its instructions are being followed, a pilot's error may be unknown until long after it has had serious consequences.
8. The restrictions that flight separation rules impose on traffic flow, necessitated by the infrequent and inaccurate positional information, limit traffic to a volume below even present requirements.

Radio ranges provide an inadequate number of approach paths into airports. Navigational instruments do not give the pilot continuous and sufficiently accurate positional information. In short, no approach control system which can handle the traffic requirements in regions of heavy traffic flow exists. The lack is most serious in regions where there are many airports.

Final-approach and *landing* traffic is hampered by the following factors:

1. The minimum letdown altitude on the radio-range legs cannot safely be lowered. Because of the broadness of the range leg and the use of the altimeter alone for obtaining elevation information, positional information as to the deviations of the airplane from a safe line of descent is not sufficiently accurate to permit descent below these minimums as a standard procedure.
2. The very limited traffic-handling capacity of the radio-range letdown procedure reaches, at best, 6 to 12 landings per hour. The CAA-Army glide-path—localizer system (SCS-51), although an improvement over the radio-range procedure, can be flown successfully only by an efficient instrument pilot.
3. No provision is made for emergency landing either of unequipped aircraft or of those in which airborne equipment has failed. There is no way for the ground personnel to monitor the descent of the

aircraft and to warn the pilot of any dangerous departure from the landing path or of the presence of other aircraft.

Available Radar Aids.—Both airborne and ground-based radars were used during the World War II as aids to navigation and control of aircraft but the problem of converting these to peacetime use is not simple. In peacetime, safety of operation is of paramount importance. Furthermore, the traffic problem stems from large numbers of individual aircraft and not from groups of aircraft, as in military situations. Fixed routes and many navigational aids do, however, simplify some aspects of the peacetime problem.

The limitations of our present navigational system indicate that an air-traffic control and navigational system must be so designed that:

1. Weather conditions (poor visibility, thunderstorms, icing, static, etc.) do not reduce safety requirements nor impose any restrictions on the capacity of the system to handle air traffic. Ideally, the system should be efficient to the point that its use is advantageous under all conditions of visibility.
2. All danger of collision between aircraft or between aircraft and terrain or fixed objects is removed.
3. It is capable of handling diversion or interruption in the flow of traffic. For example, if hazardous weather conditions exist on one air route the system must be able to divert traffic to an alternate route.
4. It can detect and correct immediately an infraction of the air traffic rules, whether voluntary or involuntary.
5. It is available to all classes of aircraft, commercial, military, and private.

With these requirements in mind, various types of airborne and ground-based aids are now discussed.

8-2. Navigation and Traffic Control Using Airborne Radar Aids.¹

Information Confined to Aircraft.—This extremely “airy” point of view is suggested by consideration of present methods of navigation and traffic control under CFR conditions. If radar instrumentation in the airplane can improve or at least equal CFR conditions and apply them to all-weather flying, present limitations on navigation and traffic control will be largely removed.

Under CFR conditions a pilot flies a flight plan over a certain route and at a specified altitude. Once off the ground he is essentially on his own. Avoiding obstructions, reporting position, navigation, approach, and landing are his responsibilities. Traffic patterns and runways are

¹ By J. H. Buck.

set up by the airport but the pilot's ability to use and follow the patterns depends on his ability to estimate his position. The radar instrumentation necessary to carry out these procedures in either CFR or IFR is discussed here with respect to enroute, approach, and landing problems.

To fly the enroute zone between two airports, the pilot must be able to fly over the best route to his destination, to "see" and therefore to avoid collisions with terrain or other aircraft, and to avoid bad weather, particularly thunderheads. To carry out these requirements under all weather conditions the pilot should have, in addition to some of his present instruments, a scanning radar for navigation and detection of bad weather and dangerous terrain ahead, and a radar collision-warning device preferably to scan through 360° in azimuth (180° possibly satisfactory) and $\pm 30^\circ$ in elevation. This collision-warning device must be able to detect approaching airplanes in time to allow the pilot to avoid them.

The first requirement can be satisfied by very slight modifications of present airborne systems. Navigation can be accomplished as discussed in Chap. 3, either by direct reference to the ground picture or by reference to beacons on the PPI.

Ground speed and drift can be obtained from the picture and a course followed fairly easily if the pilot is provided with appropriate radar maps. He cannot, however, expect to glance at the radar scope every half hour and be able to identify immediately the signals that appear. A special navigator is not required, however, since either the pilot or the copilot can plot a course on radar maps.

The second alternative provides a system of ground beacons installed along each airway to enable the pilot to fly a radar airway just as he flies visual beacons on a clear night. The beacons would be coded to avoid confusion of airways. Lateral separation with opposing traffic would be maintained by flying to one side of the line of beacons. Because aircraft can be maintained fairly accurately at a fixed distance from the line of beacons, parallel airways along which airplanes can fly different distances from the beacon line can be set up.

With either method the radar gives the pilot a means of obtaining ground speed and drift and allows him to obtain accurate range and bearing information on his check points in order to report proper fixes—a definite improvement even over present CFR flying.

The most difficult problem to be solved in the enroute region for purely airborne equipment is that of collision. Although proper scheduling and right-left separation along a radar airway reduce the hazard, the increased number of commercial and private airplanes is a complicating factor. Under present CFR, the pilot sees only about 180° in azimuth and a few degrees vertically. This is sufficient to prevent

collision with the terrain but not collisions with aircraft in heavy traffic. Any collision-warning device must therefore "see" at least this much, preferably with the addition of tail warning, and should give automatic indication of any dangerous condition.

If a reasonably good pencil beam is provided, a radar terrain-warning device can be obtained with present search equipment. AN/APS-10 equipment without the cosecant-squared modification provides a fairly simple set for this purpose and has an indicator that is easy to interpret. A narrower beam of 2° or 3° rather than the AN/APS-10 beam of 5° would improve the system.

The more difficult problem of aircraft-to-aircraft collision warning, was discussed in Sec. 4-2. The long-range warning now required suggests the possibility of equipping the airplanes with beacons coded to give altitude information so that warning is received only from aircraft in the same altitude region. The beacon signals must appear in such a way as to give both range and altitude, perhaps on a PPI which could be combined with the main radar equipment.

It should be noted that in order to keep schedules under all weather conditions all of the above airborne radar equipment is essential in any nonpressurized aircraft forced to fly over mountainous terrain. Only airplanes equipped with both radars and beacons should be allowed to fly during instrument weather.

Somewhere near his destination the pilot reaches a point where he must turn off the airway, mingle with traffic from other airways, and get into a position for landing. This is the approach zone, which at present is the bottleneck in IFR weather because of the separation required between aircraft. Using the airborne radar equipment suggested for the enroute zone, however, a pilot could follow a given route from the airways, and if cleared to land, turn into the landing pattern with traffic just as he now does under CFR. Rules for this procedure would have to be established but they would allow the pilot to make his own decision, within the regulations, from the information he would have.

Because the general clutter of radar signals around most airports makes quick interpretation of a PPI picture for exact navigation extremely difficult, one of the most promising methods for providing the pilot with suitable information in the approach zone, as well as enroute, appears to be an approach pattern indicated by beacons.

To consistently land an airplane correctly, the pilot must have better information from airborne radar than he now has under CFR. With good visibility the pilot turns from his approach pattern onto a glide-path approach to the end of the runway. But visual estimation of range and altitude causes frequent bad landings and overshooting. To prevent this, the radar must not only give the pilot some sort of glide-path and azimuth

information but must also indicate how far he is from the field and, when he is not in the correct position, how far off he is.

Some glide-path—localizer installations now in use can be modified to give the pilot most of this information without attempting to control his movements. A simple glide path, for instance, might be combined with an extension of a beacon approach path, which would prevent separation or change in procedure in the transition from enroute to approach to landing. It is doubtful, however, whether a beacon localizer could provide the very high azimuth accuracy required to bring an aircraft down on a narrow runway. Thus, the best solution for purely airborne radar appears to be a combination of a glide-path—localizer system with a beacon path leading into it. The question still remains whether this method of providing instrument landing is preferable to a system like the ground control approach, GCA.

In sum then, it appears that under present traffic conditions an airborne radar system can be devised that will gather enough information for the pilot to navigate efficiently from airport to airport in all weather with no more ground control than is at present exercised under CFR conditions. In all probability the system would require ground installations such as radar beacons instead of the radio ranges and visual beacons used under CFR. Furthermore, all aircraft flying under IFR would have to carry radars and beacons in order to provide collision warning. Such a system appears to be essential for the future on open airways, particularly in mountainous terrain.

The final approach and landing zones present the greatest difficulties. In these zones the system will begin to fail in bad weather for the same reason that CFR flying fails—because of increased traffic. At present, most airports have no difficulty under CFR conditions, but traffic around New York and Chicago is already reaching the point at which more control is needed. Because of its ability to provide accurate fixes, airborne radar will improve the congestion somewhat, with the result that IFR traffic will be equal to present CFR traffic. If, however, traffic becomes still heavier, policing to enforce strict adherence to the rules will be necessary, and for this to be effective more knowledge will be required on the ground.

Information Relayed to Ground.—To prevent the confusion caused by the airborne radar system under conditions of heavy traffic, coordinating ground agencies will be needed at busy centers to carry out more intense policing duties. This arrangement is almost analogous to our present automobile-traffic-control system—on the open highway certain safety rules are occasionally enforced but otherwise the driver is left to his own devices. As congested areas are approached, rules are more rigidly

enforced, passing of other automobiles is limited, and in congested districts (as in the landing zone) the traffic is limited to a single line.

If the coordinating agency is to have a complete picture from the airborne radar systems the following minimum information is required from each airplane: first, position—range and bearing from a radar fix, and destination; second, ground speed and preferably air speed; third, altitude; and fourth, identification.

Overlooking for the moment the very important problem of airplane-to-ground communication that enters into any system of traffic control, let us consider the transfer of the above data from airplane to ground. In the enroute zone the data are transmitted primarily to provide an over-all picture for the coordinating agency so that it can forecast traffic conditions and aircraft arrivals at various airports. Airborne radar can provide accurate position and ground-speed information which are of prime importance here. Identification of the aircraft is of equal importance in all zones and must be made an integral part of all transmissions. In the enroute zone, altitude information is used only to determine whether the aircraft is following the flight plan.

In the approach zone the altitude information becomes of equal importance with the position and speed data. Because it is not possible to maintain the 1000-ft separation in heavy traffic, the pilot and the coordinating agency must have accurate altitude information. For uniformity, this should be barometric altitude rather than terrain-clearance data. The present barometric altimeter, if corrected for local conditions, appears to be sufficiently accurate. Ideally a barometric altimeter should have the following attachments:

1. A receiver with follow-up to feed corrective data to the altimeter so that it may be corrected by ground stations transmitting local barometric pressures.
2. A data take-off to a transmitter which sends out the altitude signal of the airplane—for example, the take-off should change the frequency of an oscillator in accordance with the altitude.

With these accurate position, speed, and altitude data at hand the ground coordinating agency can predetermine traffic conditions and know exactly when to slow down, detour, or hold aircraft.

Although in normal circumstances the information obtained from the various aircraft will be sufficient to keep plots and to keep traffic operating smoothly, it is essential that an overriding policing control be provided for emergency conditions. The ground coordinating centers can obtain additional information from a few ground surveillance radars located

only at the busiest airports and possibly at intersections of a few congested airways.

An Illustrative Flight.—It is possible to imagine the following flight between Chicago and San Francisco in a radar-equipped aircraft using this system. The pilot files a flight plan giving scheduled time of departure, route to be flown, flight number (if commercial), type of aircraft, and scheduled time of arrival at destination. A few minutes before departure time, the pilot is given clearance, exact time of take-off, cruising altitude, and points at which to climb and descend. In addition, he is given a summary of expected traffic conditions at various check points along his route.

The pilot climbs to 1000 ft and flies toward a beacon 10 miles away, which marks the edge of the through airway. After the pilot has passed the beacon he turns on course and climbs rapidly at the side of the airway to a 20,000-ft cruising altitude, watching all the time for other aircraft beacon signals. His PPI presents beacon responses from other traffic and indicates that all airplanes are at least 1 mile to his left; it also coincides with the traffic conditions predicted on his clearance chart. As he levels off at 20,000 ft he finds no traffic nearby so he swings in toward the line of beacons and settles on course 5 miles to the right of this line.

Let us suppose that the cabin pressurization begins to fail halfway between Cheyenne and San Francisco. This immediately forces the airplane down to at least 12,000 ft for the sake of the comfort and safety of the passengers; however, the pilot finds thunderstorms and very low visibility at this altitude. Under these conditions, flying amid high mountains would be extremely dangerous because static would cause indistinct radio ranges. With the airborne radar on combined search and beacon operation, however, the pilot can continue his course, swinging off occasionally to avoid thunderheads that appear on the radar scope. The terrain-warning device in the aircraft enables the pilot to keep clear of dangerous peaks.

The control center at San Francisco has been notified of the change in flight and is kept informed of the progress of the aircraft as the pilot reports in at various check points. Because the airplane will arrive late, plans for its arrival are changed at the San Francisco control center to fit it in with other scheduled flights. As the aircraft approaches San Francisco, the control center informs the pilot that it is necessary to hold the airplane for four minutes beyond the estimated time of arrival. On receiving this information, the pilot cruises the last 75 miles at lower speed. At the new scheduled time, he flies over the approach pattern check point, follows the approach beacon into the glide-path—localizer pattern, and lands the airplane safely.

During the last few miles of this journey the airplane, of course, was seen by the surveillance radar. Because no traffic violations nor emergencies occurred, however, no "overcontrol" was applied.

As previously stated, no such system is available at present but it appears to be entirely feasible. This system insures utmost safety to each aircraft under all conditions, allows flexibility of flight path and control, and permits flights to be made at the pilot's discretion but with an overriding safety control at busy centers.

In this as in every other navigational and control system, however, the communications problem is extremely serious. For very dense traffic the ground must be able to send and receive information from isolated areas of space—in other words, to carry on spot communication. If spot communication proves impractical the minimum requirement is a directed pencil- or narrow fan-beam communication system probably requiring microwave techniques.

8-3. Navigation and Traffic Control Using Ground-based Radar Aids.¹

The air navigation and traffic-control system that is to operate under conditions of increased air traffic will probably be some combination of airborne and ground equipment guiding the aircraft through space and regulating the traffic almost entirely by automatic means.

However perfect such a system is, there will be occasions when the uniform flow of traffic breaks down and unsafe conditions arise because of failure of the equipment, infringement of the regulations, or congestion that requires the human element to cope with the situation. Such deficiencies in the airway control system must be corrected by airway traffic supervisors from traffic-control centers. These men must have an accurate and complete up-to-the-minute picture of the status of the air traffic, complete overriding control of any automatic control system, and the facilities for sending information or directions to one or more aircraft or airspaces.

Most of the information needed for this system can be obtained from ground-based radar and can be used in at least three different forms having widely different degrees of complexity and utility. The discussion of these different philosophies is followed by a general description of radar systems and special equipment which might prove useful in reaching a solution.

In its simplest form this system might consist of long-range ground radars, with air-traffic controllers giving instruction to the pilot by voice radio, a procedure that proved successful during the war. If ground-based radars were operated with a network of the navigational aids like the present CAA network, several of the weaknesses of the CAA system would be eliminated.

¹ By M. A. Chaffee and G. C. Comstock.

Because these radars could give highly accurate positions of aircraft, the load on the radio networks now used for positional reports by the pilot would be somewhat relieved. The ground controllers would still have to give the pilot accurate positional information if he were off-course, and they would warn him if he were about to enter an unsafe area. This accurate positional information would reduce considerably the danger of terrain collision (usually due to the pilot's being off-course), and permit a substantial increase in the traffic on the airways.

Such a system of traffic control suffers from the fact that a very high degree of coordination is required among all controllers issuing instructions to the aircraft and because its success depends heavily on radio-voice communication on overloaded radio networks. These disadvantages can be partially eliminated by adopting a system of intermediate complexity that feeds the data into equipment that automatically does most of the work of the controllers. Computing machines, such as an adaptation of GPI, can be used to predict future positions of aircraft and automatically sends out warnings to prevent collision.

With a system of fixed or moving blocks, the controllers could see to it that only one aircraft occupies a block at a time; each block would appear on the PPI together with the signals from the aircraft. This application of video mapping (Sec. 7-12) would permit the controllers to determine at a glance the position of each aircraft in its assigned block. The control information could be transmitted to the aircraft in much the same manner as messages are transmitted with beacons, by a bank of colored lights giving the pilot instructions to hold, turn right or left, or change his altitude.

In any system the pilot must be able to indicate that he has received control information. Furthermore, he must be able to challenge the ground controllers at all times if for any reason he feels it necessary to have the control procedure altered, for example, if he desires to change altitude or take an alternate route.

Those who adhere to the third control system believe that further drastic reduction in ground-to-plane voice transmission is essential. Automatic transmission of data by radar relay (Sec. 7-11) would give a PPI presentation in the cockpit of as much of the ground display picture as the pilot desired.

Any visual presentation in the cockpit must be kept as simple as possible. The pilot is not interested in having a picture of *all* the aircraft about him. He would prefer a pictorial display of his position in relation to his destination. The beacon signal from his own airplane would serve to identify it and a moving electronic marker would indicate the proper course to be taken. The pilot's job would then be to stay on the correct course and at the speed that the ground controller designates. Entire

supervision of this procedure remains with the ground controllers who have access to exactly the same display as the pilot and can monitor his decisions.

Proposed Rough Specifications of Radars for Airway and Airport Control.—The design specifications for an airway-control radar system depend somewhat on their projected disposition along the airways. Let us investigate the distribution required for effective supervision of air traffic.

The radar beam is propagated in a line which is slightly curved toward the earth by atmospheric refraction, following a curve that has a radius $\frac{4}{3}$ that of the curvature of the earth (see Sec. 1-4). Let h_a and h_t represent the height, in feet, of the antenna and target respectively. The maximum distance D at which a target is above the radar horizon is given approximately by the expression $D = \sqrt{2h_a} + \sqrt{2h_t}$. The distance D in this case, is expressed in statute miles.

If the radar antenna is placed 500 ft above the surface of the earth, an aircraft 100 miles distant would be seen if its altitude were higher than 2400 ft. For the radar to detect all aircraft above 1000 ft, the maximum distance from the aircraft to the radar set should be no more than 77 miles. For this to be possible over a large area, say the entire United States, radar systems with antennas 50 ft above the surrounding terrain must be located 150 miles apart; 250 such stations would be required to cover the entire United States. With such a distribution, a radar range of 100 miles for small single-engined aircraft allows sufficient overlap. This is equivalent to a range of 200 miles for the detection of a four-engined airplane considered in Sec. 7-1.

The distribution of airway control centers in any area would depend upon the traffic density. In the areas of greatest density, a control center would be located at each radar site. In areas of less density, radar information could be relayed to the control center from adjoining radars.

It was explained in Sec. 1-2 that range resolution is defined by the pulse length, and azimuth resolution by the beamwidth. Furthermore, range resolution does not vary with range, but azimuth resolution does when considered in linear dimension. A 1- μ sec pulse length permits resolution of two objects more than 500 ft apart at any range and a beamwidth of 1° resolves two targets 1 mile apart at a distance of 57 miles. The accuracy with which position can be determined from an echo on a PPI is much higher than the resolution. Position can be measured to approximately one-tenth the angular beamwidth and one-half the pulse length.

A system using a beamwidth of 1° might be useful for the surveillance of the airways. Since it is to be expected that airplanes can be kept at

least 1 mile apart, a 2- μ sec pulse could be used, permitting a range resolution of 1000 ft. As compared with a 1- μ sec pulse, the 2- μ sec pulse allows a small increase in range without serious loss in efficiency.

The requirements for a radar for surveillance and air traffic control in the vicinity of airports are somewhat different. Because information must be obtained at intervals of 5 sec or less, a scan rate of at least 12 rpm is indicated. This would cause a trail of signals from a single aircraft to persist on the tube face, enabling the controller to estimate at a glance the speed and course of an airplane and thus make quicker identifications. Fortunately, the range requirement for a four-engined airplane could be reduced from 200 to about 70 miles. Since the repetition rate could then be tripled or increased in the same ratio as the scan rate, the same number of pulses per target per scan would result, if the azimuth beamwidth of 0.9° were maintained. Since most of the air traffic is at lower altitudes in the vicinity of airports, coverage to 15,000 instead of 30,000 ft would be adequate, but this coverage should extend from 70 miles out to directly over the airport. Also, since the traffic is more congested, the 500-ft resolution obtainable with a 1- μ sec pulse would be desirable. In order that airplanes may be clearly distinguished from the ground clutter of numerous nearby signals, moving target indication, MTI, should be used.

A radar for air supervision should "see" clouds that are dangerous, but not see the ordinary rain clouds that merely clutter up the screen. Only rough estimates can be given for a wavelength to detect the intense storm centers alone, but for a high-precision radar about 10 to 15 cm is the most desirable figure. It has been found that, in general, clouds seen on a 10-cm radar are dangerous to flying, but at 3 cm large areas of returns from harmless clouds are visible.

Special Equipment.—Because the altitude of an aircraft changes much less than its other coordinates, height information is most important when two aircraft are on converging courses. A height-finding radar may be tied to the search equipment by using a common rotating mechanism (e.g., V-beam) or it may operate independently of the search system but in such a manner that the range-height information may be easily coordinated with the range-azimuth data for purposes of identification.

It appears that all height information can be obtained by a separate height-finding radar, but the complication of such an instrument may outweigh the usefulness of the knowledge gained. It is possible that height information can be obtained more easily and in several ways from the airborne equipment. The pilot can give his altitude by radio communication, or the aircraft altimeter can send out a response by radio or radar method which can be read from a ground station.

Indicators for presenting information must be added in the control

room or installed in a special radar control room so that radar information added to the control tower can be coordinated with the nonradar data already available at the tower.

As in the airway control centers, a large PPI will be the principal indicator for search data. Experience with experimental equipment indicates so far that the clutter-free off-center PPI with a video-mapping feature is a most effective device in supplying the airport controller with an up-to-the-minute picture of his traffic problem.

At present, the 12-in. PPI appears to be the best one available commercially; a 20-in. PPI is now being used for experimental purposes. Tubes with brighter traces may soon be available for use in less subdued light. A study of other types of indicators such as dark- and bright-trace tubes, photographic projection, etc., should be made to see whether indications can be obtained that are more effective and more adaptable to the partially or completely lighted rooms than are the ordinary CRT's.

The ability to add the exact position of runways, other airfields, radio ranges, holding points, etc. to the azimuth picture and to be able to off-center the picture without distortion has been found to be a most vital aid.

The operator should be able to use at will any one of several range sweeps equipped with corresponding fixed range marks and angle marks, to choose normal radar video signals or MTI video signals, to add video-mapping features, and to add such identification aids as indications of direction-finding equipment using communication radio or the response to beacons in target aircraft.

Another attachment useful for controlling aircraft presents the radio direction-finding bearing on the PPI. This is best done by a rotating shaft of light with the PPI map center as the center of rotation. The rotating is synchronized by remote methods with the direction-finding equipment. When a radio reception is made, the shaft of light intersects the radar echo of that aircraft and gives immediate identification. This means of identification is much more effective than that which depends so heavily on the commonly used flight plan. As traffic increases, still more positive means of identification can be achieved by installing a beacon in each aircraft. The beacon, triggered by the radar beam, gives a response which can be coded for positive identification of the aircraft. Fortunately, beacons can be made light enough to be installed in small private airplanes. The number of PPI's used depends on the density of traffic. Each PPI should display no more than an area in which the number of aircraft does not exceed what the controller can efficiently handle. One great advantage of radar is that it can handle increased traffic density merely by the addition of more displays. In regions of low traffic density, one controller with one PPI can do the entire job. High traffic density, on the other hand, may require as many as twelve

controllers and twelve PPI's. Although radar could cope with this situation, it may overload the limited number of radio channels.

To avoid the danger of collision, one-way traffic lanes which would consist of two vhf radio beams parallel to each other, each for traffic in opposite directions, have been suggested. Assignment of different altitudes for different speeds would make this a smooth-flowing system.

The crossing airways present another problem that has been partially solved by assigning odd altitudes for, say, the east-west, and even for the north-south, airways. There is, however, the ever-present possibility of error in altitude, especially in private airplanes where check on the instruments is not so rigid. A radar height finder could detect this error, but the number of height finders required would be very great. Perhaps the best solution would be to give the pilot more information about surrounding aircraft.

This discussion of the incorporation of ground-based radar into the air-traffic-control system has been based on the premise that any system of traffic control is improved by increasing the accuracy of the data. The second premise is that additional equipment should not be added to the aircraft, with the possible exception of a radar beacon. Such a modification would not require a simultaneous change in the entire system but would occur at the rate at which radar equipment is made available. The suggested radar equipment and aids for control are those actually used in wartime. Other aids can be devised or adopted to reduce further the guesswork on the part of the controllers.

The introduction of search radar into the air-traffic-control system will not solve the problem completely, but it will temporarily alleviate the present difficulties. Unless more efficient ways are devised to control aircraft, the control system will soon bog down with increased traffic. If it is assumed that control is to be exercised when two aircraft pass on an airway, it can be shown that the number of passings increase as $(n/2)^2$ where n is the number of aircraft. This means that a 10-fold increase in traffic would require a 25-fold increase in work by the controllers. An attempt should be made, therefore, to increase the efficiency of each controller in order to avoid a tremendous increase in controller personnel.

Control in Approach Zones.—The complexity of the control problem may vary from just a few airplanes per hour in the approach zone to traffic densities of 150 to 200 per hour, which the major airfields in a large metropolitan area like New York must handle. The amount of radar indicating equipment required depends partly on the traffic load. The way in which the radar information is utilized in the control procedure is bound up in the general problems of how human controllers or mechanical control devices are to compile this information, what kind of traffic

patterns and flight procedures are to be used, and how control instructions are to be issued to the pilots.

There are at least three general viewpoints of the problem of approach control that merit discussion. The first two of these are based on supplying control information over voice radio channels. The third would transmit the control information either as automatic coding or as relayed pictorial information to be presented in display or meter form to the pilot.

As an introductory and interim procedure, it has been suggested that the tower controllers should be supplied with one or two PPI's as supplementary sources of information, and a range-height indicator mounted into the control desks. This may possibly eliminate the reporting-over-fix procedures now used by pilots to supply ground controllers with positional data, and hence greatly reduce aircraft-to-ground communication.

It has been suggested also that with radar surveillance of the existing stacking areas, the present holding procedures could be retained with modifications allowed by the additional position knowledge supplied the controller from the radar indicator scopes, and result in reduction of the time separation of the airplanes emerging from such a stack to 2 or 3 minutes with no reduction in the degree of safety now attainable. Such a method of control would not attempt to produce exact spacing between aircraft nor to eliminate the stack forming. If airplanes could be brought in with 2- to 3-min spacings rather than the 12- to 15-min spacings now necessary, it is expected that for the next few years instrument-flying traffic densities would not be so great as to require large holding stacks.

It is very doubtful whether tower controllers could benefit much from radar scope data without almost continuous concentration on the scope presentation. It seems probable that the controller finding himself more and more dependent on the radar data will wish that either he himself or an assistant become essentially a PPI operator. It is difficult to see how these indicators can be added to the tower without an increase in control personnel since with high handling rates the function of ground control will be likewise intensified.

Although this limited application of radar information may alleviate some congestion for a few years and can be considered as a necessary step in the education of tower personnel in radar techniques, little real advance in safety and efficiency of control can be expected without a very radical change in the fundamental procedure. Such a change is suggested by the second viewpoint which involves expanding the control room of the tower into a radar operating center. This means an increase in personnel to obtain and coordinate positional data and to issue control information, and the addition of automatic mechanical or electronic devices to aid in the analysis of routine problems, thereby releasing human controllers for more important duties.

Such a control room need not involve the large number of personnel associated with similar radar centers for control of military aircraft during the war. It does, however, assign definite tower personnel to scope positions to observe continuously changing radar data. It is thought that the use of three or four PPI's to observe particular sectors either in azimuth or range may be required, with a height-finder operator to furnish height data. The use of large plotting-boards in approach zone control is not considered so economical in manpower and time.

Senior or master controllers will have to supervise the analysis of the information presented. One of their major jobs will be to effect the desired spacing between the airplanes being directed off or onto the airways. Paper study and the little experimental evidence that is available show that if a specified control pattern is to be followed this spacing cannot be accomplished without the aid of correlating devices to indicate to the controllers the relation between the actual and desired position of every airplane.

One means of accomplishing this is to add to the PPI indicators either mechanically, optically, or electronically, a series of moving lines or dots spaced according to the desired separation. These lines would be assigned to the different airplanes approaching the field from the different airways. The controller's function would be to give the pilot whatever instructions are necessary to keep his airplane coincident with the corresponding line or pip. If traffic patterns called for feeding all airplanes into the airport through a common point, such lines might be a series of concentric circles about the "gate" point. Vacant spaces could be left in the pattern to provide holding spaces for itinerant aircraft or those making emergency landings.

Control in Final Approach and Landing.—The navigational information and traffic-control procedures utilized in the approach to an airport have put the aircraft into such a position relative to the runway that the pilot can begin his final instrument approach at a safe interval from aircraft in front of and behind him.

The following appear to be the major requirements for an instrument approach system:

1. The system must provide the pilot with aural or visual information as to his position with respect to a safe glide path. This sense of relative position must be in both horizontal and vertical planes and must be of sufficient accuracy and of such easily interpretable presentation to allow the pilot to make a descent to within a few feet of the runway surface, from which point a visual landing is made. For a completely blind landing, the pilot must be supplied

before contact with information such as the drift "crab" angle in order to change his direction down the runway.

2. Indication of the distance of the airplane from the runway is necessary. Continuously available range information is preferable to one or two checks.
3. Indication of the ground tracks of the airplane and the rate of closure with respect to the desired glide path helps to smooth the path by eliminating oscillations about the correct path.
4. The pilot must have means of determining that both ground and airborne equipment are functioning correctly so that he can use the information coming to him aurally or visually or break off his approach because he knows that it is erroneous.
5. The ground must at all times be ready to warn pilots, as they land, of dangerous departures from the landing path, and of proximity to ground obstacles and other aircraft.
6. The system must provide for the emergency landing of radio-equipped aircraft unable to carry the normal instrument-landing gear or of airplanes in which the airborne equipment has failed. This implies continuous ground surveillance and some form of "talk-down" procedure with the help of data obtained on the ground.
7. The system should supply the data necessary for control of an automatic pilot so that eventually a completely automatic landing system can be achieved.

In Sec. 7-8 a ground scanning radar approach system, GCA, developed for use by the Army and Navy was described, and its advantages pointed out. In its present form it combines a short-range radar for surveillance of the airport traffic with the final landing function. Only the 3-cm final-approach portion need be considered here because the surveillance function has been discussed.

The 3-cm radar, with its two narrow beams scanning the glide-path region in azimuth and elevation, provides the essential elements of a system that meets most of the general requirements listed above.

Although three ground operators are now required, development is under way aimed at presenting to a single operator on one cathode-ray tube all the very accurate navigational information obtained. This single operator who observes directly the radar signals in azimuth, elevation, and range, and the ground track of the airplane can give information to the pilot by radio and ensure a safe approach. A single operator could handle airplanes at 2- to 3-minute intervals. With duplicate indicators and two operators, so that one man could handle every other

airplane, a higher rate of landings could be attained. If a remote indicator were provided at the control tower, the operation of the landing system could be completely integrated with the traffic-control system.

A radar system like this can be used in two ways: first, as a "talk-down" instrument-approach system in itself, or, second, as a supplementary system auxiliary to a beam approach system, such as one with a localizer and glide path, to make up for its deficiencies. Experience with the GCA system has shown that, in the accuracy of the information it provides to the pilot as to his relative position in the glide path, in the availability of range information at any time during the approach, in its ability to warn of the presence of obstacles or other planes, it provides a facility that can be used successfully by even a fairly inexperienced instrument pilot. Because only radio equipment is required in the airplane, the GCA constitutes a generally usable emergency facility that has proved its usefulness time and again.

Although radio transmission of navigational information to the pilot by another person is of great value in providing flexibility for use of GCA as an emergency device, it is, paradoxically, the major deficiency of the GCA procedure. During instrument flight, the pilot cannot determine completely whether the transmitted data are correct. By following blindly the information and instructions given him, he is at the mercy of the ground controller, and subject to the controller's errors in speech and judgment. It is true, of course, that the pilot's confidence in the system can be established by trial flights in good weather to demonstrate that the information obtainable from the system is accurate. The many thousands of GCA instrument approaches (made by service and transport personnel), many hundreds of them with ceilings below 100 ft, and a number of landings under zero-zero conditions, show that such confidence can be established. To maintain it, however, the ground control personnel must be expertly trained and entirely reliable. One of the demonstrated advantages of the talk-down method, particularly for the relatively inexperienced pilot, is the reduction of tension of the pilot who does not have to make difficult interpretation of navigational information normally presented on meters or by aural signals. It is still true, however, that many pilots approaching a difficult landing through dangerous terrain in soupy weather, would like to be able to "see" their relative positions for themselves and then take decisive action on their own responsibility, and to be able to tell when any incorrect decision has been made by the ground controller.

There appear to be three possible ways, none of them tried operationally as yet, to present by indicators in the cockpit at least some of the radar information now available on the ground. One obvious method is to take the azimuth and elevation deviations obtained by manually

tracking radar signals (now obtained as voltages and applied to error meters for the controller) and transmit them as modulation on radio carriers so that they can be applied to suitable indicators in the cockpit. Such a procedure would require that the ground personnel manually track each aircraft with the possible transmission of tracking inaccuracies and errors to the pilot.

A second and much more desirable procedure would be to add semi-automatic tracking features to the ground equipment—not an automatic-tracking radar whose antenna follows the motion of the airplane, but a system of electronic gating in range and azimuth (or elevation) of the radar signals of the scanning radar so that the signal would be followed automatically in the two coordinates. By comparing electrically the position of the tracked signal with the desired azimuth (or elevation) for a given range, a deviation voltage could be obtained and transmitted to the airplane as such a modulation. Continuous range, and even the rate of approach to the runway, could be similarly obtained and transmitted. A ground operator would still be given his scope pictures, but the tracking gates would show as pips. Thus, the operator would act as a monitor to make sure that the tracking equipment was functioning correctly. He would always be available as a talk-down controller in emergencies or for unequipped aircraft and could serve as a master controller by radio if the pilot failed to follow his own indication properly or was in danger of collision.

A third system, involving either radar relay or television techniques, would be to present pictorially to the pilot, preferably on a cathode-ray tube, the radar information obtained on the ground, and to use ground indicators solely as monitors. No method has yet been devised to present by radar relay the sector scan type of indication normally used in the ground landing radar, but it is not inconceivable that workable devices could be produced.

It may be that, at least for the immediate future, instrument approaches can be most safely achieved and the most protection afforded by the combination of the two distinctly different microwave aids, a localizer—glide-path fixed-beam system with a ground-based radar scanning system.

The beam system would give the pilot direct deviation information. The scanning radar would provide surveillance of each descent with the possibility of overcontrol function for correcting deviations from the desired path and for giving warning of obstacles and airplanes. The scanning radar would likewise provide the function of a talk-down procedure for unequipped airplanes, those whose equipment is not properly functioning, or for any pilot who prefers such procedures.

It is certain that, whatever aid is eventually adopted, microwave techniques will be utilized completely.

Advantages and Limitations.—Three proposals have been made for the use of ground-based radar and other auxiliary equipment to provide some of the information necessary for the solution of the air-traffic control problem. The most complicated of these is one in which the information is automatically relayed to the pilot. This costly method requires a large amount of equipment and many controllers on the ground, and the installation of both beacon and radar relay equipment in all airplanes flying under IFR conditions. Although it cannot yet be decided whether the return would be commensurate with the expense of production, this proposal does have certain advantages. The pilot would have before him all the basic information necessary for making his own decisions. He would not have to depend on the judgment of someone on the ground who would be ignorant of many of the factors involved in flying a particular airplane at a particular moment. He would have before him on the PPI a video map showing the traffic situation, the general plan of traffic control in effect at that moment, the intersection of airways, the approach pattern of airport runways and, above all, accurate indication of his own position with respect to all of these. These indicators, similar to the off-center PPI's, would show in maplike form an enlarged picture of the area immediately surrounding the airplane. The off-centering of the range and the selection of the azimuth in this area could be done automatically by simple equipment in the airplane. The picture would have the same orientation as the ground under the pilot as he looks out the window.

He would have his own choice of sweeps so that he could look at the entire area, or in heavy traffic see only those aircraft at nearly the same altitude as his own. Important ground features could be indicated on the video map without any ground clutter.

Such a system requires that the ground controllers set up only the general traffic plan and that the pilots fly the aircraft with the same freedom as under contact flight rules, but with much more extensive and complete information at hand. The density of traffic under these circumstances could be very much higher.

Several maps could be transmitted by radar relay either on several different frequencies or by time-sharing on the same frequency. The selection of these maps might include a general facility map, a detailed terrain map, a weather map showing positions of dangerous storm areas, and an emergency landing map showing all landing fields within the immediate vicinity of a particular airplane. These maps could all be coordinated at the ground stations to prevent confusion regarding the position of the aircraft relative to each fixed location.

The same general procedure could be used both on the airway and in the approach zones. As an approach for landing was to be made, the amount of information required would be considerably increased. It seems reasonable to suppose however, that techniques can be developed which would enable the pilot to land under IFR conditions with little or no dependence on the judgement of ground controllers. These last would direct traffic and monitor all landings without giving detailed instructions.

On the airways and in the approach zones, the pilot would have at his disposal information from a radar having 360° azimuth coverage, adequate vertical coverage, high resolution in both range and azimuth, no ground return, and a range of at least 100 miles on all types of aircraft. The complicated equipment requiring skilled personnel, together with suitable stand-by equipment, would be on the ground. Only relatively simple equipment capable of presenting all the available information, and probably not weighing more than 75 lb, would be in the aircraft.

8-4. Summary of Proposed Aids.¹—The last two sections have described how airborne and ground-based radar equipment may be used to help solve the problems of control of air traffic. Although the opinions expressed in the two preceding sections differ in their emphasis on the relative importance of airborne or ground-based equipment in solving the problems, there is agreement as to what a specific airborne or ground-based radar can do. The uncertainty lies for the most part in regions where human factors predominate. It is clear that a careful plan including the best combination of aids to traffic control and air navigation must be put into operation before there can be a substantial increase in air traffic under IFR conditions.

Airborne radar aids alone can greatly improve navigational accuracy and help the pilot avoid bad weather and terrain collision. Traffic lanes along the airways can be delineated by coded ground-based beacons. Collision warning against other aircraft probably can be achieved only if beacons are required for all aircraft flying under IFR conditions. Airborne radar should be particularly useful in overwater flight where the pilot must often obtain his own weather information and where the number of aircraft would be so small that beacon standardization could be more easily achieved.

Ground-based radars can provide more information but require a substantial outlay of money for establishing a network of radar control centers over the entire country. In spite of the expense, these would remove the necessity of having the same airborne beacon installed in all types of aircraft as a safeguard against collision. A PPI presentation relayed from the ground to the airplane should allow the pilot considerable

¹ By J. S. Hall.

freedom of action, and at the same time permit the ground controller to monitor and control the traffic. In regions of uneven terrain this system will have blind areas but these can often be made small by mounting the antennas at commanding positions.

Improved ground facilities such as GCA or a glide-path—localizer and beacon arrangement might be used as aids to landing under conditions of very poor visibility. High-intensity lights and fog dispersal methods effectively raise the ceiling under conditions of poor visibility and provide added safeguards when used with the facilities mentioned above. At congested airports, ground surveillance radars might be used advantageously to control traffic at all times.

To repeat, a combination of airborne and ground-based aids is indicated. Whether the eventual solution puts the main emphasis on airborne or ground-based equipment, the principal difficulty will be encountered at or near the airports where there is a definite limit to the number of aircraft that can be controlled. Means of accurate navigation in the airplane will help simplify the situation and reduce the load on the controllers.

It would be sadly negligent not to emphasize the close relationship of radars, beacons, and communication equipment. The frequencies and codes used for the radar-beacon combination and for radio communication must be rigidly standardized. It is of no use to try to interrogate a beacon with a radar which transmits at the wrong frequency or does not respond to the frequency of the beacon reply; it is of little avail to receive a coded beacon reply and not know what it means. Furthermore, it does not help a radar controller to know that two airplanes are on collision courses and then to find himself unable to communicate with either.

Even under the stimulus of war the Combined Communication Board was not able to achieve a unified system. Although the outlook for the peacetime standardization of beacons on an international scale is not bright, standardization may be possible within the boundaries of the United States because such coordination comes directly under the jurisdiction of the Federal Communications Commission. Otherwise, confusion and a considerable waste of money and materials will result from lack of coordinated planning.

A number of interested groups, including the CAA, the Army, the Navy, the commercial air lines, and private fliers, are concerned with the general problem of air-traffic control. It appears to be necessary that a small, highly competent group of men (working it is hoped, in close cooperation with similar groups in other countries) be empowered to select the best solution, the adoption of which would be mandatory.

Obviously, these men must be carefully chosen to ensure a wholly impartial analysis of the problem.

The question of who would pay for these radar aids naturally arises. At first thought, it might be supposed that all equipment in the aircraft should belong to its owner, and that the ground-based equipment would be paid for partly by the government, partly by a tax on owners of private aircraft, and partly by a surcharge on fares for travel on commercial air lines. The economic aspect of the problem is beyond the scope of this book. Any solution must, of necessity, include standardization of all equipment. This may necessitate government ownership and operation of ground-based equipment and government supply of airborne equipment on a rental basis. A company might be established for this very purpose.

The cost to the government of modernizing its air navigation and traffic-control system may be comparable to what it expends on other aids to navigation. These include maintenance of lighthouses and other useful markers, dredging of rivers and harbor entrances, etc. It also maintains the United States Coast Guard, whose chief peacetime function is to safeguard the lives of mariners in distress. Few, if any, question the value of these services. From a strictly economic viewpoint the increase of air traffic resulting from such a modernization might more than compensate for its cost.

The advisability of interim measures and piecemeal installations which are not a part of long-range planning is questioned. Although these might put more airplanes in the air in the next few years, they would also be expensive and eventual standardization would be retarded because of natural reluctance to displace such interim equipment. Even though the growth of air travel in the near future might be delayed by taking time to work out a comprehensive system, the long-range advantage would more than make up for the temporary delay.

In conclusion, it is necessary to emphasize again the importance of making it possible for a small group of able men to study this problem, to formulate a solution, and to dictate a policy. These men may make mistakes, and their dictatorial power might be objectionable from some points of view. But it is possible only in some such way to bring order out of chaos and save the American public vast sums of money.

•

PART IV
SHIPBORNE RADAR

CHAPTER 9

NAVIGATION AND PILOTAGE

BY R. M. EMBERSON, J. P. NASH, E. E. MILLER, D. B. McLAUGHLIN,
AND C. A. SMITH

9-1. How Radar Can Help the Navigator.¹—There is perhaps no peacetime application of radar where its advantages are so clearly indicated as in shipborne navigation. Wartime experience has shown clearly that even a simple radar is so useful that its cost is very small compared to the return, especially for freighters and passenger ships engaged in world-wide or coastwise trade. The use of radar should reduce the danger of collision to such an extent that vessels so equipped might often proceed at full speed even under conditions of poor visibility, thus saving one or two days in passage. Furthermore, at their destinations, they could be docked without delay under conditions which would otherwise be impossible.

It was shown in Chap. 2 how long-range electronic navigational systems like Loran may be used as aids to navigation far at sea. It was also explained how the direction-finding stations along the coast can give navigators fixes within a range of 100 or 200 miles. When land masses rise above the optical horizon, shipborne radar becomes important as an aid to navigation or pilotage. After a land mark has once been identified, the navigator may easily determine its bearing to one or two degrees and its range with an accuracy of 100 or 200 yd. This far exceeds the capabilities of a human eye, or even of optical devices such as stadimeters and range finders. In short, the navigator may determine a fix with an accuracy far greater than that to which he has been accustomed.

Pilots in harbors, rivers, and lakes find radar information extremely helpful. The photographs in this section are of PPI's attached to sets especially designed to provide both high and close-in resolution. Their important characteristics are narrow beamwidth, short pulse length, and fast indicator sweeps. Figure 1-17 (Sec. 1-8) shows an aerial photograph of the Sagamore end of the Cape Cod Canal and a PPI photograph showing the entrance of the canal taken on a ship about a mile offshore. Figure 9-1 shows two photographs taken while the ship was actually passing through the canal. The range circle has a diameter of 2000 yd. It is

¹ Sections 9-1 to 9-3 by R. M. Emberson.

easy to see that the ship was "centered" in the canal. Bridges or other similar objects can also be identified.

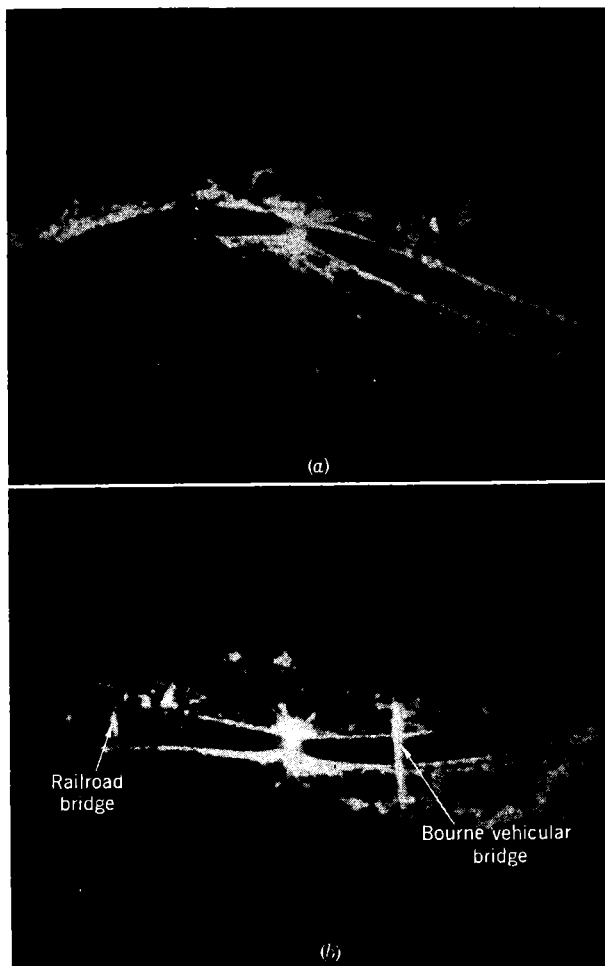

FIG. 9-1.—PPI of a high-resolution radar when the ship was in Cape Cod Canal. A railroad bridge at 1300 yd and a vehicular bridge at 800 yd are conspicuous in one photograph.

Figure 9-2 is a PPI photograph taken from a ship in Boston harbor. The arm-like configuration in the upper left corner leads to the junction of the Charles and Mystic rivers; the individual wharves and piers can be easily identified. Although it is possible to superimpose a map or chart on the PPI, it is not usually necessary in close waters. The motion

of ships in harbors is slow enough to allow even inexperienced pilots to identify the various objects on the PPI by reference to a nearby chart.

In coastal waters, the radar navigator detects buoys, lighthouses, and other ships. By comparing the coastline with the PPI he can obtain accurate fixes as often as he desires. The range at which he can see the coastline depends, of course, on the heights of the coastline and the radar antenna, and the wavelength used. This distance may vary from 5 to 50 miles or more.

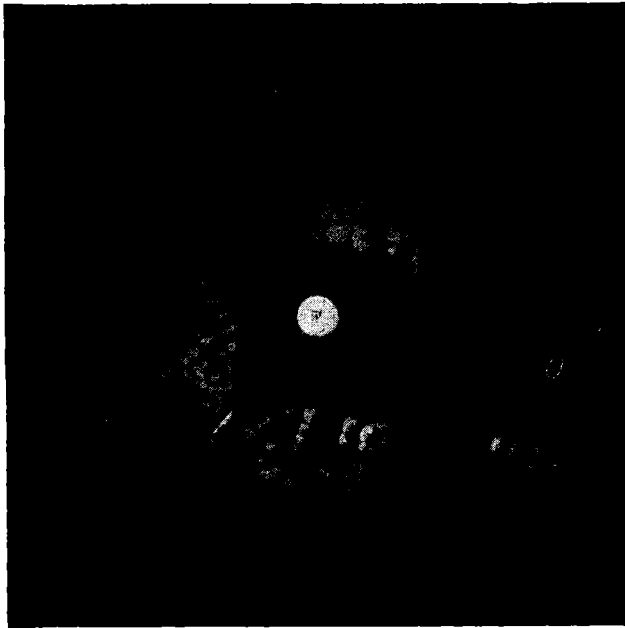

FIG. 9-2.—PPI photograph taken from a ship in Boston Harbor.

An unpublished study sponsored by the Navy and Coast Guard has shown that both a 10-cm and a 3-cm radar will detect icebergs many miles away. As the icebergs melt and disintegrate, detection becomes more difficult. When they have melted down to "growlers" (that is, a chunk of ice so small that it rises and falls with the motion of the waves), the detection range is reduced to a very few miles; if the sea is rough, the growler signal may be masked by signals from the waves. Since growlers may show only as much as 5 or 10 ft above the water, with the largest portion submerged, they constitute a real danger to shipping that present radars do not entirely eliminate.

A shipborne radar should be useful to the navigator as an aid in

forecasting the weather. A series of echoes which represent a cold front is shown in Fig. 9-3. These echoes represent areas of showery unsettled conditions. The return from a typhoon which occurred near the Philippine Islands is pictured in Fig. 9-4.

It is important to remember that radar has its limitations. It cannot seek out only those targets of interest to the navigator and ignore all others. Each signal in the indicator represents some object and until

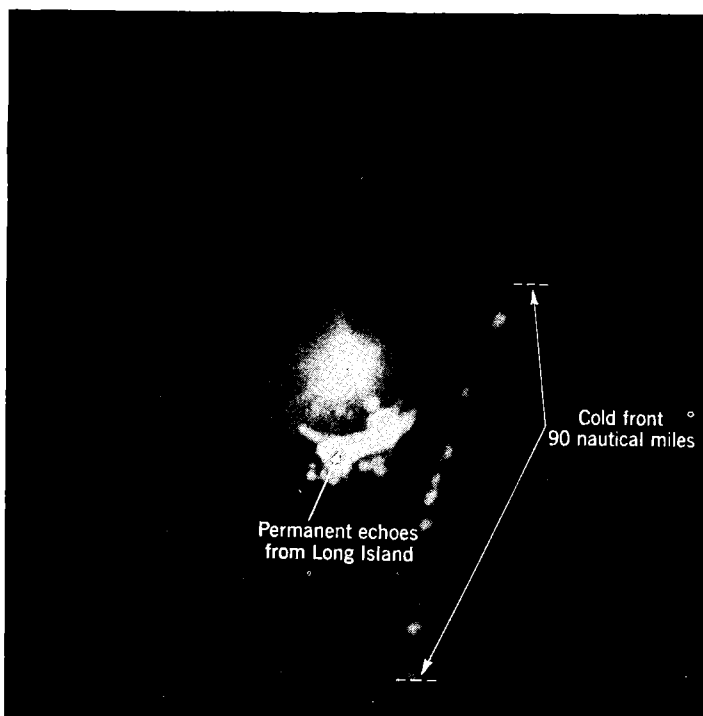

FIG. 9-3.—A cold front. This photograph was taken with an experimental high-power radar at the General Electric Plant, Bridgeport, Conn., by Mr. G. W. Fyler.

that object has been identified it may portend danger for the ship. The experienced operator knows that the small signals that appear for only a short time and then disappear come from waves, birds, or whales and porpoises breaching in their play. Persistent signals may come from a rough patch of water over a submerged reef, a rain cloud, an iceberg, or a ship or other floating object. It is never safe to ignore a persistent radar echo.

9-2. Coordination of Radar Data with Other Data.—Modern microwave radars can supply graphic information of the position of a ship

relative to other objects within the field of view. Many other devices, however, some of long years' standing, furnish equally important information. The modern gyrocompass provides a fixed reference line. Fathometers (sonic or supersonic) continuously indicate the depth of water under the keel. Mechanical sounding devices can determine not

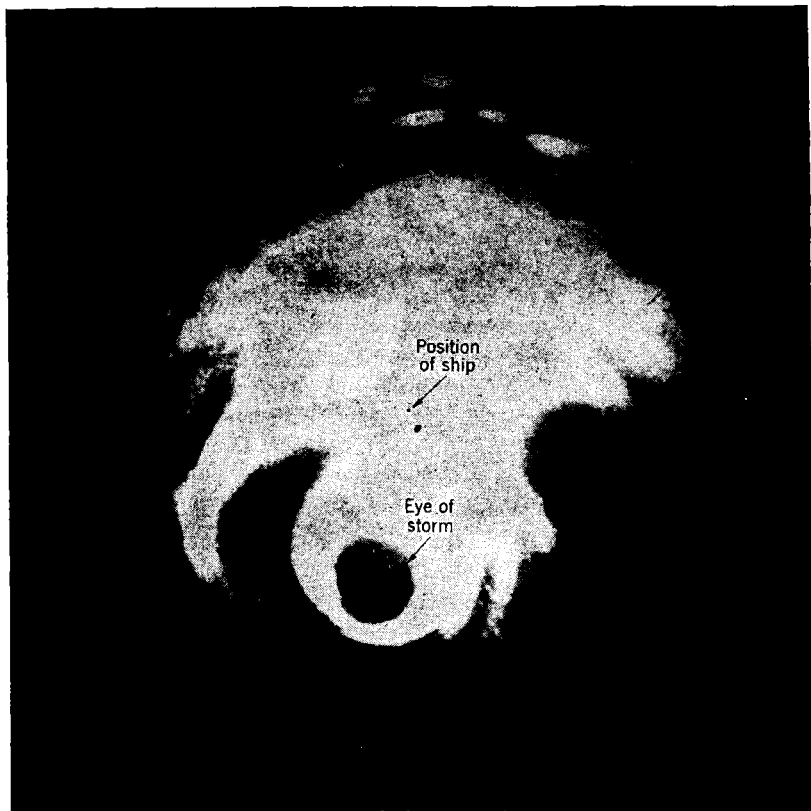

FIG. 9-4.—A typhoon as it appeared on the PPI of a high-power 10-cm radar.

only the depth of water but also the character of the ocean floor. Aural aids (bellbuoys, whistles, and horns) are valuable under conditions of poor visibility. All visual aids (the peloruses or, better, self-synchronous alidades, buoys, fixed ranges and lights) actually constitute the most basic means of pilotage when conditions permit their use. A good pilot automatically collects all the available data, judges its relative merits, and then formulates his conclusion. Some correlation may be done instrumentally. For example, compass data may be assimilated by the

radar to provide a true bearing display. But, in general, the separate instruments are too divergent in character to permit an easy and simple combination. Radar information should be presented on the bridge or at another point convenient for the pilot or navigator in such form that it can be seen and understood at a glance without need of deliberate mental gymnastics.

9-3. Marine Radar Beacons.—Although radar beacons were widely used for air navigation during the war, the war ended before they could be put into operation for marine use. It is apparent, nevertheless, that they could have been extremely useful.

Location.—In regions where there are a large number of accurately charted and easily identifiable radar targets—in harbors, for example—the capabilities of existing marine radars are such that beacons may have little to contribute to safety and ease of navigation. The shortest beacon codes now in use are 2 to 3 miles long and they might so clutter up the indicator that beacons actually would be undesirable. (Shorter codes can be used when expanded sweeps are in common use.) But, on the other hand, codes might be unnecessary in such locations; the beacon could reply with a single pip, which the operator would recognize as a beacon simply because the signals were received on the beacon frequency rather than the radar frequency. This would be practical only in locations where one beacon could not be mistaken for another.

Beacons would probably be of the greatest value when a ship approaches a coastline or enters a harbor where the number of useful points of navigation is relatively small.

There are intermediate waters like Chesapeake Bay and Puget Sound, for which it is difficult to make a prior judgment. In Puget Sound, in particular, the channels are lined on both sides by high land masses that give false echoes because of the weak side and back lobes of the antenna pattern. These echoes obscure targets in other directions. Low-powered beacons might prove useful here.

Operational Use.—The techniques described in Sec. 3-8 for air navigation with beacons could be applied in marine navigation, but because the speed of a surface vessel is much less than that of an airplane the beacons would be most useful in simply getting continuous running fixes.

Beacon signals tend to spread in azimuth at short ranges if the receiver gain is not reduced. High land masses near the ship may act as mirrors and reflect radar signals to the beacon and beacon signals back to the radar. Under these conditions, also, the false signals can sometimes be eliminated by reducing the receiver gain. The problem is primarily one of beacon siting, discussed at greater length in *Radar Beacons*, Vol. 3, Radiation Laboratory Series.

Beacon Design.—The use of interrogation coding was discussed in Sec. 1-9. There it was stated that the purposes are to reduce the demands on the beacon transmitter and to eliminate partly the false signals that are seen when more than one radar is interrogating the beacon. Beacon transmitters can be designed to withstand any likely overloading. Clumsy and complicated as they might be, they would permit simplification of the radar. Because there will be far fewer beacons than radars, the use of powerful beacon transmitters would be an economical solution to this problem, but interrogation coding helps solve the problem of false signals in regions of dense traffic.

The density of traffic on the seaward side of a coastline beacon might be small, and its antenna could be designed to be insensitive to interrogation from harbors and other waters carrying heavy marine traffic on the landward side. In such a case, interrogation coding would be unnecessary. Unless it can be shown, however, that in every location either (1) the situation is such that beacons are not needed or (2) the marine traffic within a range of several miles will never be very dense, it would appear that interrogation coding should be used.

Beacon signals will be of benefit only at limited ranges, except in coastline installations. Since the signals from a sensitive and powerful beacon are displayed as very wide arcs on the PPI of a nearby ship, sensitivity and transmitter power of the beacon receiver should be limited in some locations.

From this discussion and that in Sec. 1-9, these rough specifications for marine radar beacons can be set down:

1. The maximum range of each beacon should be determined by its particular location.
2. The receiver should cover the entire marine scatter band.
3. The beacon should contain an interrogation decoder if it is so situated that traffic conditions warrant it.
4. The transmitter must be accurately held to the assigned frequency, preferably by an automatic mechanism.

Radar Design.—The operator should be able to switch radar echoes or beacon signals, or both together, onto the indicator. When both are presented, the beacon signals should be appreciably brighter than the echoes. This means that there should be a beacon receiver with a higher video output level that is separate from the radar receiver.

There may be a delay of as much as 2 or 3 μ sec in the beacon response. This is important when fast sweeps are being used. It may be compensated for by delaying the sweeps an equal amount. When echoes and beacon signals are to be presented together, the echoes must also be delayed.

In the past, the most common form of interrogation coding was a long pulse, which requires a somewhat complicated modulator and often a reduced pulse-repetition rate. The coding may be done, however, by using two or more short pulses of the same total length as a single search pulse. Another method, which was used with IFF sets during the war, is to have a second low-frequency radar interrogator synchronized with the microwave set. The beacon operates only when signals are received simultaneously from both radar and interrogator.

The rough specifications for the marine radar to operate with beacons, then, may be summarized as follows:

1. Interrogation coding.
2. A separate beacon receiver with a video output level higher than that of the radar receiver.
3. Provision for presenting the output of the receivers separately or together.
4. For extreme accuracy with fast sweeps it is desirable that compensation be made for the delay of the beacon response.

9-4. Corner Reflectors.¹—It is sometimes desirable to increase the radar reflecting properties of a target to make its echo stand out more clearly on the indicator. During the war, it was found that rubber life rafts could not be detected by radar sets of searching aircraft. When a special target, called a corner reflector, was included as part of the emergency rescue equipment of the rafts, however, they could be detected from a range of many miles.

Corner-reflector buoy markers should prove to be a valuable aid to pilotage because some buoys are difficult to detect, especially the nun buoys which have smooth curved surfaces. Bell buoys are more easily detectable, but even the echo from one of these will be more prominent if a corner reflector is mounted on it. This is especially true when the sea is rough and sea return obscures the relatively weak signal from a buoy. Radar pilotage along a channel can be carried out easily under all visibility conditions if all buoys are easily detectable. Corner reflectors placed at strategic positions on land can sometimes solve marking problems. This is possible where the land signals are weaker than those from the corner reflectors.

Corner reflectors have also been used to intensify the echoes from small boats. They would aid materially if used in small boats on fishing banks, both to keep the boats from being run down by ships when visibility is poor and to enable a radar-equipped mother ship to keep track of them. Echoes from an 8-ft corner reflector attached to a meteorological

¹ By J. P. Nash.

balloon have been followed from 3 to 63 nautical miles. The height of the balloon, measured by radar, at this maximum range was 43,000 ft.

The most effective target with a given intercepting area is a flat plate, mounted perpendicular to the incident radar beam. The radar cross section can be very large if the wavelength is small compared with the area of the plate. Unless the flat plate, with its highly directional characteristics, is perpendicular to the radar beam, however, very little radiation is returned.

The corner reflector takes advantage of the large radar cross sections obtained from a set of properly oriented flat plates by returning radiation over a much wider range of angles than does a single flat plate. It con-

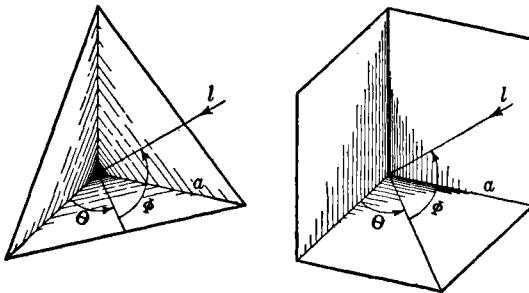

FIG. 9-5.—Triangular and square corner reflectors.

sists of three mutually perpendicular intersecting metallic planes, analogous to the floor and two side walls in the corner of a room. Two corner reflectors, differing in the area of the planes used, are shown in Fig. 9-5. The radiation reflected from all three of the planes will be sent back in the direction from which it came. The same principle is applied to the small glass reflectors used as highway markers to reflect light into the driver's eyes. The highway reflector is purposely made imperfect so that reflected light fills a cone large enough to include not only the source (the automobile headlights), but also nearby receivers (the driver's eyes).

The maximum amount of energy will be returned to the radar if its radiation is directed into the corner reflector in such a way that the direction of propagation makes equal angles with all three planes. As the direction of the incident radiation is changed with respect to the optimum position, the amount of returned energy diminishes but very slowly when compared to the energy reflected by a single flat plate at optimum orientation.

In Fig. 9-5 the optimum values for θ and ϕ are 45° and 35° , respectively. In practice, the corner reflector is oriented so that the line l is in the direction of the radar antenna. For use on ships this direction is

horizontal and may be achieved by tipping the unit forward 35° or by using a cluster oriented as shown in Fig. 9-6.

Clusters of corner reflectors are usually used so that the target will be a good reflector in all directions; the most common arrangement consists of eight triangular corner reflectors arranged as shown in Fig. 9-6. This arrangement will give the proper orientation to four of the corners when the search radar antenna is directed horizontally, making the orientation correct for shipboard radar sets.

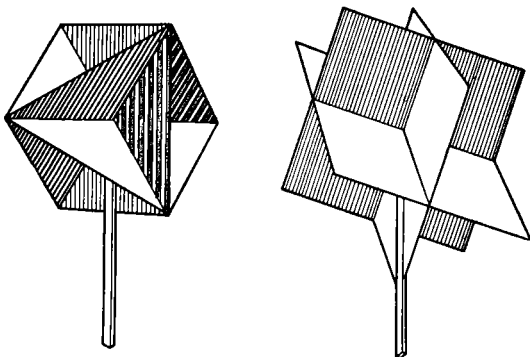

FIG. 9-6.—Clusters of corner reflectors.

An idea of how a corner reflector returns energy from various directions (sending it back in the direction from which it came) can be obtained by considering what happens if ϕ is held at 35° and θ is varied. The results are summarized in Table 9-1, along with some data showing the directional nature of the return from a flat plate for purposes of comparison. It has been assumed that the plate is 2 ft^2 on a side oriented with two edges vertical, and that the radar antenna directs the energy horizontally. The wavelength assumed is 10 cm; for shorter wavelengths, the effect of turning the plate is even more critical.

TABLE 9-1.—VARIATION OF RANGE WITH CORNER-REFLECTOR ORIENTATION

Reflector type	Variation of θ from optimum	Energy reflected relative to optimum, per cent	Optimum range free space, per cent
Triangular corner reflector	26°	42	80
	33°	17	64
Square corner reflector	15°	42	80
	24°	17	64
Flat plate	2.5°	42	80
	4.0°	6	50

It is apparent from the table that a corner reflector is an efficient target over a large range of angles, and that a flat plate is practically worthless as a target except when the radar beam is perpendicular to its face.

The radar cross section of a corner reflector can be easily calculated for optimum orientation. It is given by¹

$$\sigma_s = \frac{12\pi a^4}{\lambda^2} \quad \text{and} \quad \sigma_t = \frac{4\pi a^4}{3\lambda^2}$$

for units made of squares and triangles, respectively. The dimension a is a side of the square or a short side of the triangle, as shown in Fig. 9-5. A calculation of σ_t for a equal to 2 ft and λ equal to $\frac{1}{3}$ ft (10 cm) gives a radar cross section of approximately 600 ft². A 2-ft triangular corner reflector has approximately the same radar cross section as a boat about 80 ft long; to get comparable ranges with the corner reflector it must be mounted at least as high as the effective heights of the other targets. If the wavelength is 150 cm the radar cross section is only 2.7 ft². It is thus apparent that small corner reflectors, in order to be useful targets, must be observed with microwave radar.

It is evident from the formulas given above that the area of the radar cross section of the square corner reflector is nine times that of one made of right triangles with legs equal to the sides of the squares. There is only twice as much material in the square reflector, but it is used more effectively. The reflection from the square corner reflector, however, falls off more rapidly with deviation from the optimum (see Table 9-1) so that for wide angles the triangular corner reflector is more efficient for the same area.

In free space the factor of 9 will make a square corner reflector at optimum orientation visible about 70 per cent farther than a triangular one at optimum orientation in which the triangles are each half as large as the squares. Over water, however, the advantage is less for low targets, i.e., targets which are below the lowest lobe in the intensity pattern. In the "surface region" (defined in Sec. 10-1) there will be about a 30 per cent range advantage with the square corner reflector.

There is a simple range dependence on size of either type of corner reflector. Since the radar cross section varies as the fourth power of the length of the side, the free-space range varies directly as the length of the side. In the surface region the range varies as the square root of the length of the side.

Figure 9-7 shows a polar plot of free-space range against bearing for corner reflectors oriented as in Fig. 9-6, and it reveals the nature of the

¹ R. C. Spencer, "Optical Theory of the Corner Reflector," RL Report No. 433, March 2, 1944.

coverage to be expected from energy that reflects from the planes of the reflector. The four main lobes of the pattern are not equally spaced over 360° ; a study of the corner-reflector cluster oriented as in Fig. 9-6 will show that they should not be. Such a study will also reveal that when the cluster is so oriented that it gives one of the nulls between the large lobes, it is in a position to return energy from two planes intersecting along a horizontal line or from a flat plane perpendicular to the radar beam. In the figure, a value $a = 6\lambda$ was assumed in order to calculate the single-plane and two-plane patterns. Extensive experiments, which were carried out during the development of corner reflectors for life rafts,

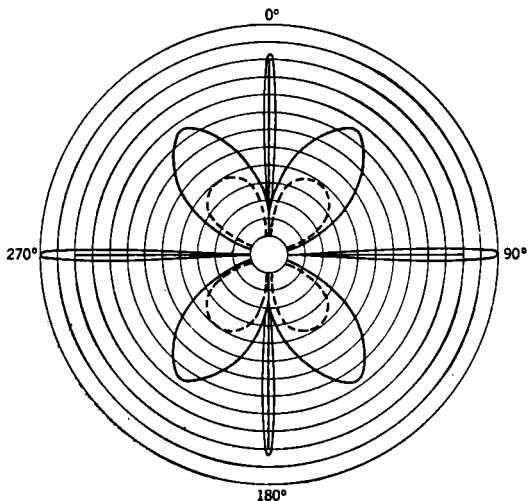

FIG. 9-7.—Angular distribution of energy from a cluster of corner reflectors. Solid lines, square corner reflectors. Dotted lines, triangular reflectors.

failed to reveal any pronounced effect on range when the cluster was viewed over a wide range of angles.

Because it is easier to construct, the triangular corner reflector has been used much more than the square one. In particular, if flexible metallic fabrics are to be used for the conducting surfaces, the triangular cluster can be made with a minimum of rigid members. This design was used in the construction of folding corner reflectors for rubber life rafts;¹ a photograph of one of these units is shown in Fig. 9-8. A similar design should undoubtedly be adopted for life boats and rafts of peacetime ships. The units developed for the armed forces were made of triangles with a short side approximately 2 ft long. Much larger ones

¹ J. P. Nash and E. L. Hudspeth, "Corner Reflectors for Life Rafts," RL Report No. 608, Aug. 1, 1944.

would be practical for large lifeboats, and the corner reflectors could be mounted considerably higher than the 4-ft height that was the limit for rubber boats.

In order to get increased ranges from corner reflectors used with ship-borne radar, experiments have been made with reflectors carried aloft by balloons or kites. It was found that increasing the height of the corner

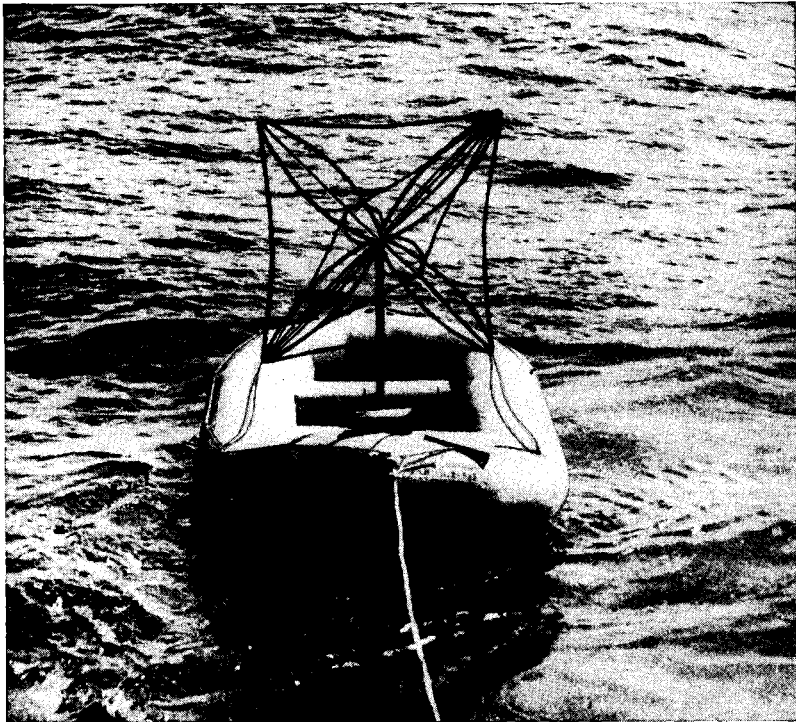
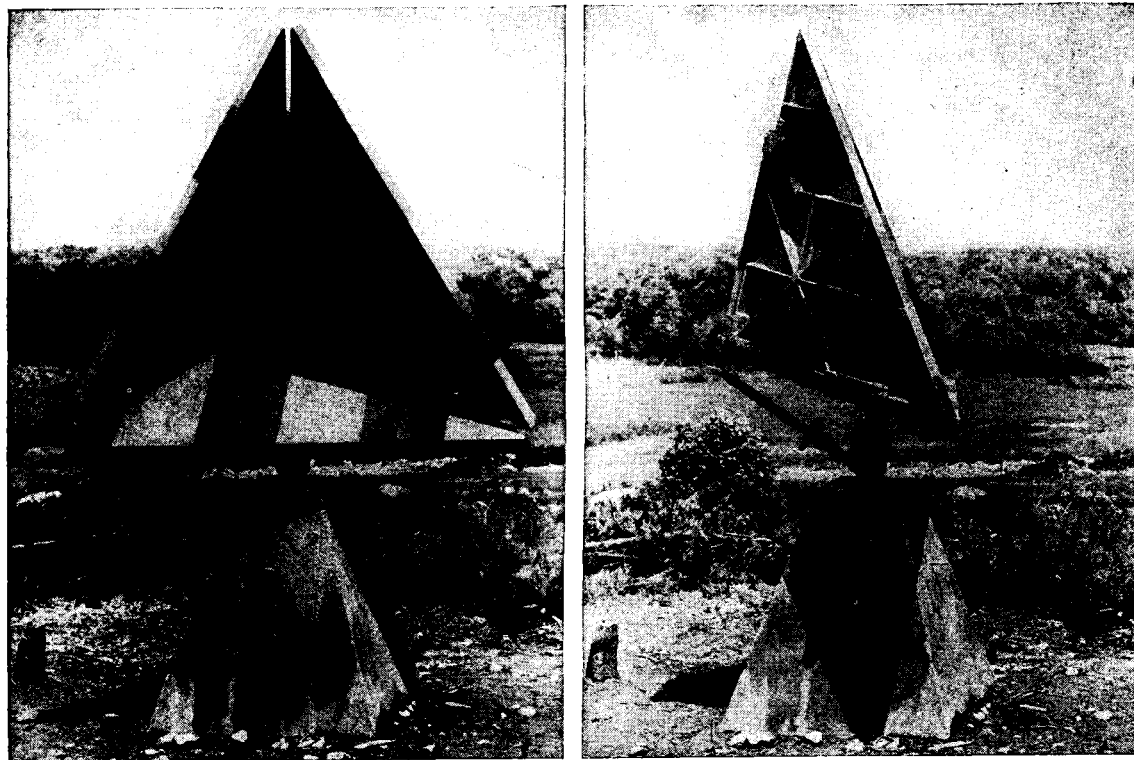

FIG. 9-8.—A corner reflector of the collapsible type mounted on a life raft. (Courtesy of United States Navy.)

reflector has little effect on airborne radar sets, but greatly increases the pickup ranges when the radar antenna is low. Ranges cannot be increased beyond a certain value, however, no matter how high the corner reflector is elevated because the radar set has a definite range limitation for a target of given radar cross section.

Efficient corner reflectors must be carefully designed. When one part of a reflector returns radiation which is out of phase with another part, destructive interference which reduces the efficiency of the reflector can be set up. Roughly speaking, a deviation of one third of a wave-



(a)
FIG. 9-9.—A 4-ft corner reflector built with close tolerances. (a) Front view. (b) Side view.

length at the outside edge of the three planes of a corner reflector will reduce the signal strength by one half. As the size of the corner is increased, therefore, the resulting *angular* tolerance allowed in construction becomes small. For example, if a triangular corner reflector with legs 2 ft long is to return at least one half of the 10-cm radiation incident upon its effective area at optimum orientation, the allowable error in construction of the three angles is 3.3° . For a wavelength of 3 cm this would be only 1° . The tolerances for square corner reflectors with the same edge sizes are even smaller. Three errors of about two thirds of a wavelength at the edge reduce the reflected energy by about 90 per cent.

If a corner reflector is to be used as a marker where weight is not an important factor, it can be made very accurate.¹ The 4-ft experimental model shown in Fig. 9-9 weighs 315 lb exclusive of the base and costs about \$1200. (This is to be compared with a cost of a few dollars apiece for reflectors used in life rafts; in Sec. 6-7 the cost of a ground-based beacon is estimated at \$20,000.) The accuracy of construction was such that its effective cross section at 1.25 cm was found experimentally to agree with the theoretical value of 600,000 ft².

The echo from this reflector at 1.25 cm was slightly stronger than that from a standard wooden airplane hangar 217 ft long and 160 ft wide. It could be detected at 30 miles with an experimental airborne 1.25-cm radar. A 1-in. displacement of one side caused the signal to disappear in the ground clutter. The ease with which this corner could be made to modulate the echo by moving one side made it easy to identify its echo. It was not possible to identify its echo with a 3-cm radar.

In sum, corner reflectors used with microwave radar have many possible applications. Although it may not be possible to distinguish a 4-ft reflector from ground clutter at 3 or 10 cm, the possibility of using larger reflectors and shorter wavelengths should not be overlooked.

9-5. Principle of Superposition Navigation.²—When a radar set is operating within range of land, its indicator displays a pattern which resembles the actual land configuration. If the operator can match the radar pattern by superposing a map on it he can easily and accurately determine his position with respect to the land. The recognition of the PPI pattern is a prerequisite to the solution of many shipborne and air-borne navigational problems.

Recognition.—Recognition is based upon the study of one or more of the following properties: (1) the relative signal intensities expected from the various topographical features and buildings; (2) the vertical dimension (height) which controls shadows and which—because of the curva-

¹ E. G. Martin, "Design of a 4-ft Corner Reflector for K-band," RL Report No. 642, Aug. 20, 1945.

² By E. E. Miller.

ture of the earth—controls the distance at which objects are visible; and (3) their relative positions and shapes in the horizontal plane.

Of these, the first is not very reliable, but the second and third are geometric properties which can be analyzed quantitatively. The second property, the effect of height, can be analyzed by using terrain models with a point of light to replace the radar; this approach, however, is tedious and subject to serious deficiencies such as the variation of PPI patterns with variations in atmospheric refraction.

The third property is the most useful and can be put into convenient quantitative form merely by optical superposition on the PPI of a map having the same number of miles per inch. When the position of the map is adjusted to match the radar pattern, each point on the map coincides with a corresponding point on the PPI. Thus, the relative positions and shapes of all features are easily and accurately compared, and the relative positions of objects with respect to each other are independent of the position of the radar set.

It is very much easier to identify a PPI pattern by matching to it a superposed image of a map than it is to find a resemblance between the two when they are observed side by side. The effects of curvature of the earth, shadowing, spreading of signals in azimuth due to the finite beam-width of the radar, and the presence of a few ships on the water frequently combine to make a PPI pattern have little evident resemblance to the map. This pattern can, nevertheless, be lined up easily by superposition so that (1) each signal (except those attributable to ships, etc.) coincides exactly with a map feature which would reasonably be expected to give a signal, and (2) conversely, no map feature which should definitely give a return fails to have its superposed signal. The variations in the pattern caused by the effects of atmospheric refraction and the unpredictable variations in relative signal strengths of various types of land features do not preclude consistently reliable results. This, then, is a basic point: the quantitative comparison of relative positions on the map and the PPI forms so good a recognition tool that it overrides the inability to predict just what kind of a PPI pattern is expected; in fact, it normally requires the use of only a small fraction of the qualitative knowledge that we possess concerning radar signals.

By the use of superposition, the relative positions and shapes of all signals can be ascertained very quickly. Some of these signals are simple and consistent, as are those from land-water boundaries for example. Others, like the difference between a river and flat land, may be confusing—sometimes the river is brighter than the land because of trees and buildings which line it; sometimes the reverse is true. But regardless of whether the course of the river is brighter or darker, so long as it matches its map counterpart in shape and position, and is consistent with the

other features, it contributes to recognition of the pattern by superposition.

A question frequently raised by those unfamiliar with the technique is: What happens when the shoreline is straight and featureless? A number of deliberate attempts have been made to find such a shoreline. They have always failed.

Matching Techniques.—As in airborne radar, it is necessary to vary the receiver gain control over a wide range in order to extract all of the useful information from the radar. Fortunately, there is normally an oversupply of information so that two or three convenient settings of gain control will suffice. The use of a three-tone PPI which shows information from two gain settings at two brightness levels, would obviously be a convenience, especially if the gain of the two levels could be varied at will. At full gain, a set with ample range will tend to block in a solid mass of signals from every land area within line of sight. Full receiver gain is, therefore, desirable for getting the initial rough match between the map and the PPI.

Any PPI pattern should be regarded as being made up of the return from a large number of point reflectors on the map. These reflectors can have a variety of signal strengths. The return from each point will appear as a broadened signal on the PPI, centered on the associated point of the map. The amount of broadening of individual signals depends upon the effective beamwidth of the antenna and may be decreased by turning down the gain so that many weak signals disappear, isolating the stronger ones.

It has been found by experience that many strong signals are located exactly on the shoreline. This is probably a combination of three circumstances:

1. Many houses, docks, sea walls, etc., are built along shorelines.
2. The objects on the shore are the nearest ones.
3. Shoreline objects are reflected in the water.

Whatever the reason, the phenomenon is very helpful because it makes possible the use of an isolating process for determining the proper position of the shoreline.

When properly matched, the shoreline should bisect exactly a number of signals which are isolated by gain reduction (see Fig. 9-10). It is expected that a large number of inland signals which, of course, are not bisected by the map shoreline will remain. Although ships may be visible on the seaward side, their signals remain isolated even at high gain, and so do not confuse the situation. The number of signals not bisected by the shoreline is immaterial, provided it bisects exactly a considerable number of signals.

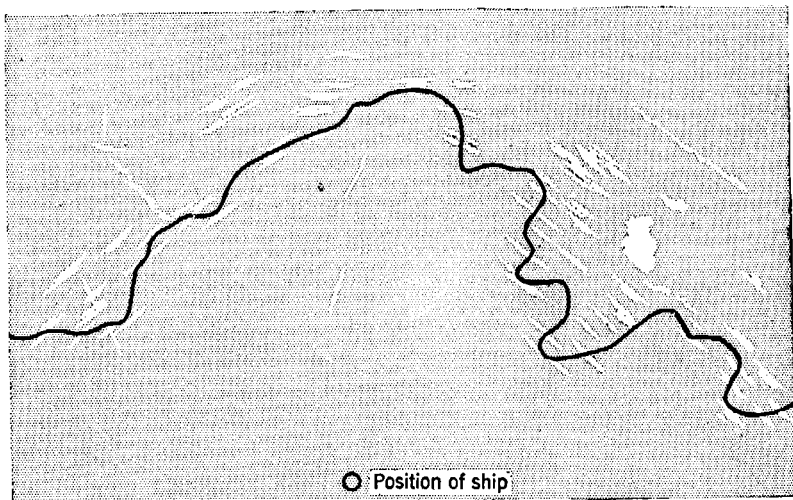

FIG. 9-10.—Bisection by shoreline of many signals isolated by reduction of the receiver gain.

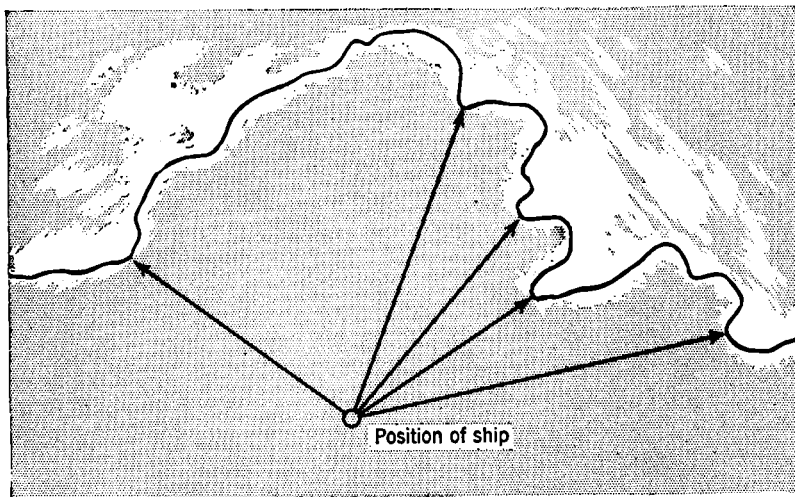

FIG. 9-11.—Tangency method of obtaining a navigational fix at high receiver gain.

When the ship is fairly close to shore, a tangency method may be used for aligning the map accurately at high receiver gain. This method is particularly effective when the shoreline is sufficiently irregular to show up definitely at two or more points which are convex toward the radar. These points can be set tangent to and bisecting the seaward arcs in which the signal mass ends. This seaward arc represents in each case

the broadened signal of the land point nearest the radar and its nearer edge is not obscured by any other signal. This is shown in Fig. 9-11. Where the shore is indicated on the map as a low flat sandspit, the extreme shore edge is considered unlikely to give a return even at highest gain, especially when the radar set is at some distance. When several points can be made tangent to and bisecting their respective signal arcs and when the remainder—which are not tangent—can be fully explained by assuming that their extremities are too low and distant to give a return, the operator is safe in assuming that his match is correct. The tangency method can be extended to small protrusions along a shore where the full arc is not exposed, although bisection cannot be used on such points. Frequently, however, when the gain is reduced, these small points and spits will be seen perfectly bisected by one or more small signals, which in effect provide tangency plus bisection in two steps.

With practice, an operator can learn a number of tricks which may prove useful when difficult conditions arise. At various gain levels, for instance, it may be possible to use map features like rivers, bridges, terraces, small isolated hills, etc. The top of a hill or ridge forms a shadow which can sometimes be used, particularly if the map shows contour or form lines to indicate the exact curve along which the shadow will start. (A shadow starts at points where the contour lines are tangent to a line connecting them to the radar position, that is, where they are tangent to the PPI trace as it crosses the region.) Bodies of water can often be outlined exactly on the PPI particularly at close range, by turning the gain very low.

The kinds of artifices used depend on the nature of the terrain. On a flat coast, even electric power and telephone lines can sometimes be matched, but in mountainous country tangencies and shadows may be the only visible features that are reliable. On one occasion, an unusual example of the usefulness of this kind of matching was provided by an underwater reef, shown on the map, which could be perfectly matched to a region of abnormal sea return caused by the breakers on the reef.

Buoys, which can be used when within range, furnish an added assurance that the match is generally correct. It has been found, however, that buoys are rarely positioned with an accuracy comparable to the radar fixes. Accordingly, an inability to match buoys accurately with their charted positions should be expected, and land features should be relied upon to furnish the most accurate fixes.

9-6. Chart-matching Equipment.¹—Several devices have been designed and used for the superposition of charts on the PPI pattern.

Direct projection of a real chart image on the tube face is out of the question because it would make the tube fluoresce and cause confusion.

¹ By D. B. McLaughlin and C. A. Smith.

All the devices described below are based on the superposition of a virtual image on the tube face, which involves the use of a partially reflecting, partially transmitting plate of glass, one side of which is coated with a nonreflecting film. In one form the reflection that is used depends simply on the ordinary 4 per cent reflection from the untreated side of the glass. In another type, the reflecting side is specially coated to transmit yellow light and reflect blue light.

Virtual PPI Reflectoscope, VPR.—The VPR is a device that presents the virtual image of a chart on the face of the PPI. A diagram of the optical system is shown in Fig. 9-12.

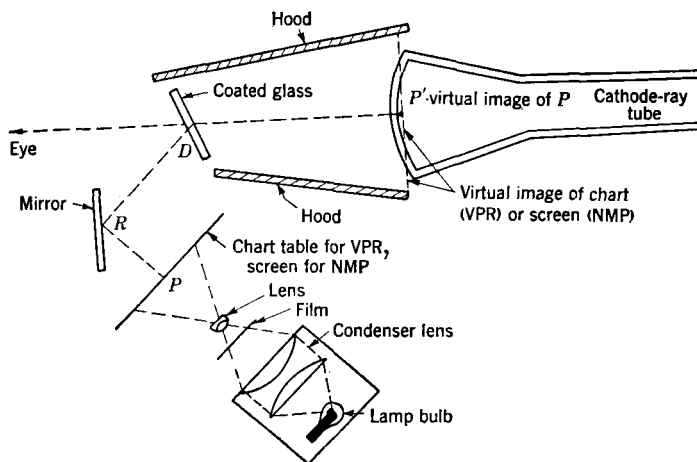

FIG. 9-12.—Optical system of the Virtual PPI Reflectoscope, VPR, and of the Navigational Microfilm Projector, NMP.

The chart table slopes at 45° to the vertical and stands in front of the operator like a sloping desk or drawing table. The mirror is vertical; the filmed glass slopes at 22.5° to the vertical with its upper edge nearer the operator and the reflecting side toward him. The operator looks into the tube along a horizontal line and sees the PPI face through the filmed glass without loss of resolution and clearness and with only a slight loss of intensity due to reflection. Light from a point on the chart is reflected first by the mirror, then by the unfilmed side of the glass plate and thence to the eyes of the operator. If the VPR has been adjusted so that the distance $PR + RD$ is equal to the distance $P'D$, then the virtual image of the chart will appear to be in a plane that intersects the curved face of the cathode-ray tube. An example of a PPI pattern superimposed on a map is given in Fig. 9-13.

When the chart is used with an indicator that shows only relative bearing, no further accessories are required. It is held by hand, flat

against the sloping chart table, and is shifted along or rotated to preserve the match with the PPI signals. In this case the top of the face of the cathode-ray tube is "dead ahead" and the operator can read off the information in terms of right or left of the course and distance along the course.

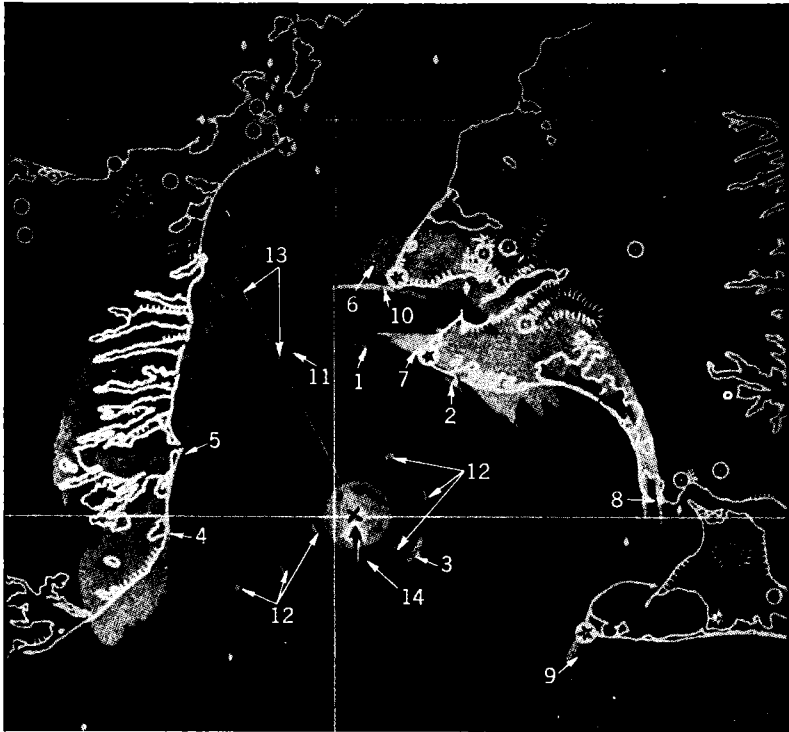

FIG. 9-13.—Example of PPI pattern superimposed on map. 1, 2, and 3 are buoys; note small imperfections in positions of 1 and 3. 4, 5, 6, 7, and 8 are points of tangency; note slight errors in 6 and 7. Extreme sand spit at 5 does not show. 9 is a signal from a lighthouse only. 10 and 11 are ships. 12 represents small signals from debris. 13 is a ship's head marker. 14 is a position fix.

When the radar is north-stabilized, north always appears at the 12-o'clock position. The chart may then be affixed to a carriage which can be translated in two coordinates. Figure 9-14 shows a VPR with such a chart table in which the motion is effected by two long screws at right angles to one another. For convenience these should be so oriented that one is due north-south and the other east-west. Then all charts can be instantly and correctly oriented simply by making an orientation line on the chart parallel to a side of the chart carriage. The use of true bearing

assures greater accuracy and speed in obtaining a match because the operator does not have to hold the paper chart in place nor change its position angle.

A gyrocompass is necessary for obtaining north stabilization automatically. On some small ships which may not have such a compass the PPI can be north-stabilized by means of a manual bearing unit. This unit is an auxiliary piece of equipment in which a differential generator is connected in series with the synchro leads from the antenna

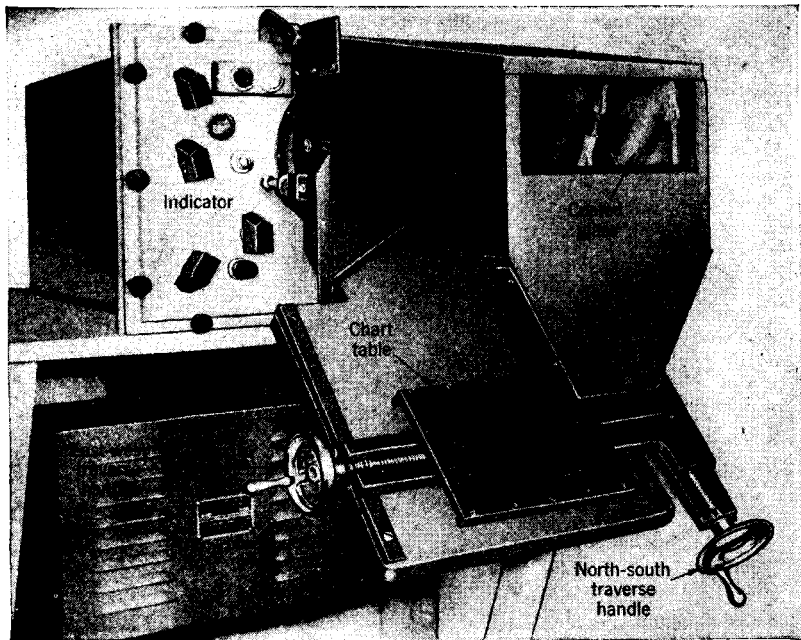

FIG. 9-14.—VPR with map table.

to the PPI. By rotating the handwheel of the manual bearing unit, the PPI can be made to lead or lag the antenna by any number of degrees. The operator can set the manual bearing unit by judging the orientation of the PPI, or, if he knows the ship's heading, he can set the unit by means of a dial, graduated in degrees, which is geared to the handwheel. Although the manual bearing unit is not automatic and does not give as good north stabilization as a gyrocompass, it makes possible the advantageous use of any of the chart-matching devices which require north stabilization described below.

The Navigational Microfilm Projector, NMP.—This projector is essen-

tially a VPR, (Fig. 9-12), but the chart table is replaced by a translucent projection screen with a film projector beneath it.

The entire projector is mounted in a frame which can be traversed in two perpendicular directions by means of long screws. Its operation is,

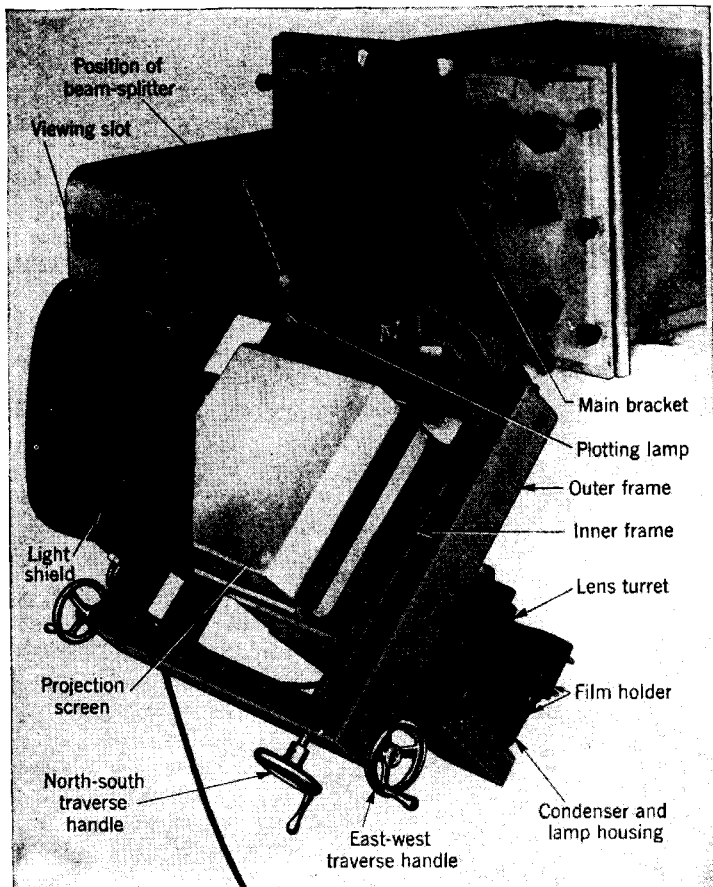

FIG. 9-15.—NMP attached to indicator.

therefore, very similar to that of the VPR with a map table. Obviously the NMP can be used only with indicators that display the pattern in true bearing because there is no provision for rotating the projector or film holder. Figure 9-15 shows the NMP attached to an indicator.

A great many charts can be carried on a 10- or 20-ft roll of film. Once a frame of the film has been placed in the film holder and correctly

oriented, the projector is moved in traverse by means of the screws to preserve the match of signals to the chart. When a screw reaches the end of its thread, it is run back, the film is repositioned, and the process is repeated.

Standard scales of film charts are 1/2,400,000 and 1/6,000,000. Films of a number of United States Hydrographic Office charts have been made to these scales. The 1/2,400,000 film can be projected with lenses that magnify approximately 6 or 12 times (giving scales of 1/400,000 and 1/200,000) to match the scales of the 12-mile and 6-mile sweeps used on Navy indicators. An alternative pair of lenses, magnifying 8.5 or 17 times is used for indicators having a 5-in tube and sweeps of 4, 10, and 20 miles. Thus, the magnification of 17 applied to the 1/2,400,000 chart gives an image of scale 1/140,000, approximately the scale of the 4-mile sweep. Magnifications of 8.5 and 17 applied to the 1/6,000,000 chart match the 20-mile and 10-mile sweeps. The pair of lenses to be used must be suited to the particular radar indicator.

Film charts should be prepared by photographing the original charts as negatives on microfilm, which gives high contrast and clear lines on a dark grey field. With proper precautions, the scale of the film chart can be kept within a fraction of a per cent.

The VPR and NMP both permit plotting on the chart (either the actual paper chart or the chart image projected on the screen). If the operator makes a mark on the chart or screen so placed that its virtual image lies at the center of the PPI, the mark will indicate the instantaneous position of the ship relative to the charted region. A course line can be laid out and divided into segments, and fixes can be expressed in terms of the distance and direction that the ship is off course. The distance along course can be designated by position within each segment. Alternatively, a rectangular grid can be used, and fixes expressed in terms of the grid coordinates.

The Autofocus Radar Projector, ARP.—The optical system of the ARP is shown diagrammatically in Fig. 9-16. The microfilm is projected on the screen SS' and since $QD = DQ'$ its virtual image appears at Q' . A two-lens autofocus projection system gives magnifications ranging from 8.5 to 42.5 and makes possible the matching of the scale of any of a wide range of PPI sweeps. With either scale of film, 1/2,400,000 or 1/6,000,000, the PPI's with sweeps ranging from 2 to 20 miles can be matched.

The single reflection between the projection screen and the eye eliminates the possibility of plotting on the projection screen. Instead of moving the projector and screen, the film is traversed in two mutually perpendicular directions by means of accurate screws. Distance counters geared to the traversing screws measure in yards the distance that the film travels on the scale of the film chart. (A gear shift makes it possible

to record the distances for either of the two film scales). The PPI center is always virtually on the axis of the optical system.

The operation is as follows: a 1000-yd transparent grid is superimposed on the navigator's chart so that the origin of coordinates is at some chosen reference point, for example, a lighthouse or other precisely located point. In the projector the image of that reference point is made to coincide with the center of the PPI and the counters are set to zero. Then, when the film is moved to match the chart to the signal pattern, the counters at once read the distance in yards north or south and east or west of the

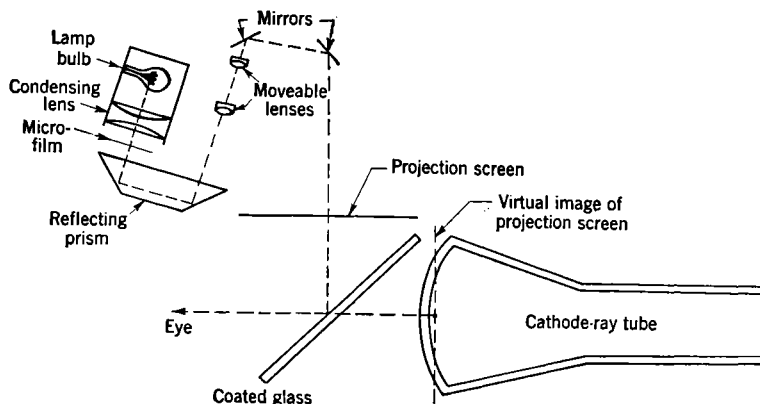

FIG. 9-16.—Cross section of the optical system of the Autofocus Radar Projector, ARP.

reference point. This fix can be quickly plotted on the chart by means of the superimposed grid.

Less accurate fixes can be obtained by the principle of two bearings. A plexiglas protractor can be slipped into a slot just above the projection screen and rendered visible in silhouette by red lamps several inches above the screen. When the protractor is properly centered and oriented, it can be used to read bearings of a selected map point. These bearings can then be plotted on the paper chart and the position of the ship obtained by intersection. The fix depends on estimation of the nearest degree (between 5° marks), however, and this does not make full use of the accuracy of the map-matching technique.

A photograph of the ARP is shown in Fig. 9-17. In Fig. 9-18 it is shown attached to a radar indicator.

The Radar Chart Projector, RCP.—The preceding instruments are accessory devices designed to be attached to already existing indicators. The RCP, however, is itself a remote indicator with built-in projector and could be connected to any one of a number of different radar sets. It is intended to be used specifically for navigation. The place for the

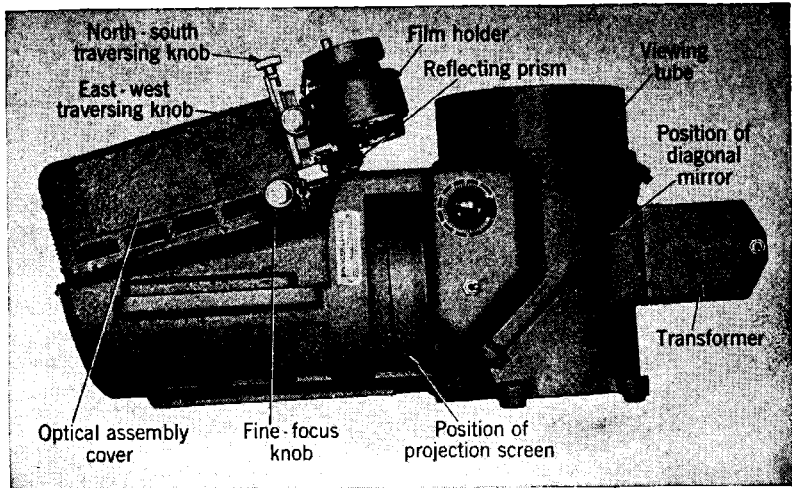

FIG. 9-17.—Side view of ARP.

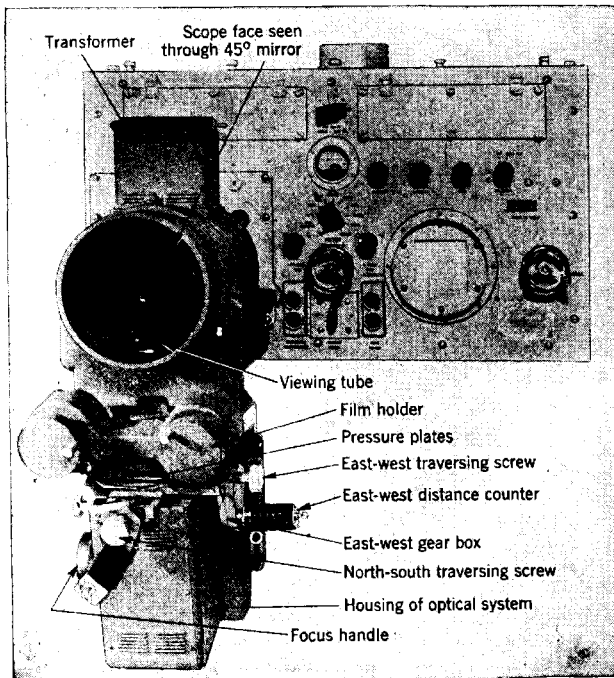

FIG. 9-18.—ARP mounted on radar indicator.

RCP, therefore, is on the bridge. The instrument is shown in Fig. 9-19 and a diagram of its optical system is shown in Fig. 9-20.

Except for the shifting of lenses to change magnification, the optical projection system remains fixed in position while the cathode-ray tube is moved in two perpendicular directions. The operator not only sees the chart in virtual superposition on the PPI by looking through the viewing lens, but he can also see the chart displayed on the projection screen on the top of the indicator. On the screen a course line can be

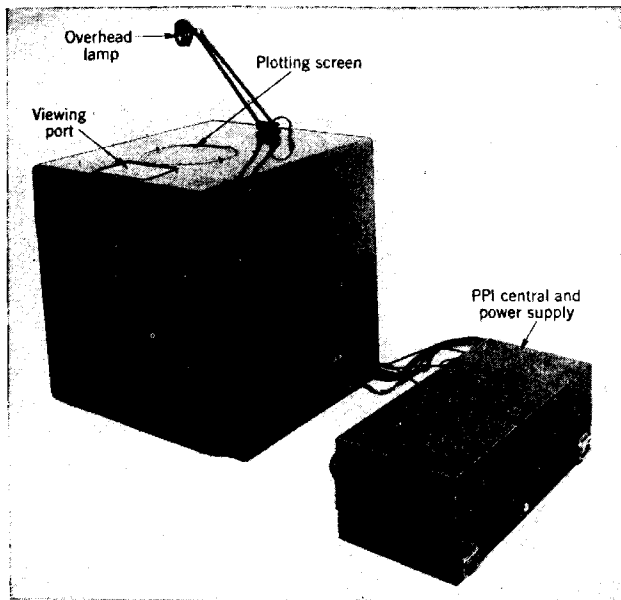

FIG. 9-19.—Radar Chart Projector, RCP.

laid off and rendered visible on the PPI by back-lighting the screen with the lamp above it. The position of the ship carrying the RCP can be plotted by making the shadow of the pencil point that is held against the screen coincide virtually with the PPI center; positions of other ships can be plotted by placing the pencil point (virtually) on the centers of the corresponding signals.

The RCP contains two projectors and film holders (scale of film $1/1,200,000$ and $1/6,000,000$). The two projectors (see Fig. 9-20) send out, to a second mirror, beams that are reflected by two pairs of prisms and a common mirror. The light then goes to the upper half-silvered mirror and from there to the screen. The image on the screen is seen reflected by the lower half-silvered mirror. Even though the passage

through these two beam-splitters involves considerable loss of light the image is bright and well-defined enough for use.

Operation is similar to that of the NMP, except that the projectors remain fixed and the PPI is moved. Almost all the features of the NMP are incorporated, including the tie-in of sweeps with chart scales.

The sweep selector switch also selects the scale of projection to match the sweep. Four scales of projected image are obtained. The 1/1,200,000 film magnified 30 times and 15 times gives 1/40,000 and 1/80,000 whereas 1/6,000,000 film with the same magnifications gives

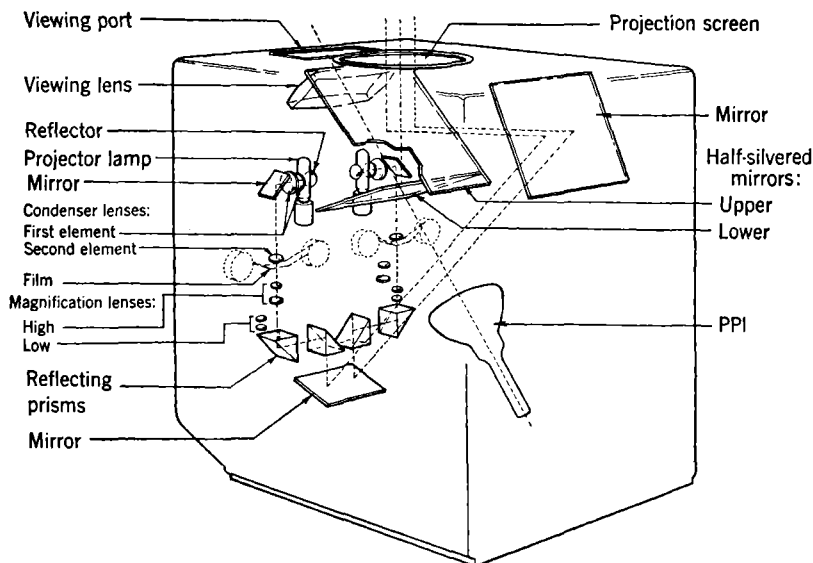

FIG. 9-20.—The optical system of the RCP.

1/200,000 and 1/400,000. These correspond on a 7-in. tube to approximately 2-mile, 3½-mile, 8-mile, and 16-mile sweeps. Precise scale match is secured by adjustment of the sweep length which varies all sweeps by about 10 per cent. No variation of magnification is possible except that due to changing lenses.

9-7. Accuracy Obtainable by Chart Matching.¹—Only two conditions normally require precise navigation: (1) operation near other vessels or other floating objects, and (2) operation near land or fixed objects. For the first, scanning radar equipment is the only safe answer, because it can detect uncooperative hazards such as icebergs, derelicts, and sea monsters. Scanning radar that employs map superposition is well suited to the

¹ By E. E. Miller and D. B. McLaughlin.

second condition because its accuracy increases as the shore is approached—just when it is needed.

Navigation by superposition, using modest radar equipment, is markedly superior to visual navigation in clear weather, except for negotiating very narrow buoyed channels or breakwater entrances, coming in to mooring or docks, etc. These latter are more problems of pilotage and helmsmanship than navigation. Extensive tests of radar pilotage by methods of map-matching have shown an accuracy that is fully as great as that to be expected from the best visual fixes based on pelorus readings. The precision of the radar fixes could not equal nor even approach that of three-point sextant fixes, nor is such accuracy necessary.

Accuracy is always limited by the accuracy of the PPI sweeps and the maps; given modern M-M PPI's with accurate range markers, and maps of United States Coast and Geodetic Survey quality, the limitation reduces in every case to the ability of the eye to detect small discrepancies at the scale of the PPI. Maximum errors over a large number of tests measure about $\frac{1}{16}$ in. on the scale of the PPI. It would be unreasonable to expect more of the human eye.

To obtain the most accurate fixes with present equipment, the use of distance counters geared to a traversable film holder appears to be the logical solution. The adaptation of such a projector to existing indicators could take a variety of forms, but use of the principle of virtual superposition can hardly be improved. Two reflections between the projection screen and the eye offer the possibility of plotting and measuring on the projection screen. One reflection makes this difficult, but the use of distance counters eliminates the need for screen plotting. The autofocus feature is not essential; adjustment of the sweep length for scale matching would be equally useful.

Although the ease and certainty of identification are enhanced by narrowing the beamwidth and by shortening the pulse length, no great increase in accuracy has been found to accompany these refinements. It is probable that most of the improvement resulted from the fast sweep rather than from the improved resolution. This surprising result was not anticipated by anyone, but the reason for it is plainly implied in the basic point brought out above, namely, that recognition by superposition is a quantitative procedure which normally requires only a fraction of the radar information available.

Because of imperfections in indicators and maps, a compromise is required when fitting a map to the PPI. It is usually necessary to tolerate some deviations in every direction and to make the general average of all deviations as small as possible. This type of averaging may be compared to plotting a large number of visual fixes on different

landmarks and taking the center of the cluster for the actual position. It constitutes a check on both the map and the PPI and, except when the information is very scanty, it furnishes fixes more accurate than those that could be obtained by precision ranging on only two or three points, because any one of these points could be inaccurately located on the map.

Although the motion of the ship between scans and during the time spent in matching detracts from the accuracy of fixes, ship speeds are so slow that the decrease in accuracy is not serious.

TABLE 9-2.—RADAR FIX ERRORS

Beamwidth, degrees	Pulse length, μ sec	Sweep length, miles	Maximum error		Equipment used
			miles	yds	
12	1	12	0.1	200	VPR, NMP
2	0.2	10	0.1	200	ARP
12	1	6	0.05	100	ARP, VPR, NMP
2	0.2	4	0.04	75	ARP
2	0.2	2	0.02	30	ARP

All the data shown in Table 9-2 were obtained from observations made on moving ships. The figures represent maximum observed errors rounded off in such a way that not more than 10 per cent of a statistically large group of errors would exceed the values quoted. The procedure used was this: fixes were given at certain intervals. Between fixes the operator ran through various gain settings, very frequently moving the map by small amounts. Satisfied with the general correctness, he concentrated on the most reliable combination of features that could all be used with some particular gain setting. He then used the gain setting and the limited selection of features for getting a fix quickly—a timed fix, if desired. Although no data obtained with RCP are available, there is every reason to believe that this device is just as accurate as the others.

One of the most serious problems is reading off the fix in suitable coordinates or transferring it to a navigational chart without incurring sizable error. This is made easier if both the matched map and the navigator's chart have identical grids. Ordinary navigational features like channels and shoals may be included on the map so that an operator sitting at the radar can plot the position of the ship directly on the superposed map and give constant course and speed instructions to the helmsman. This method is probably the simplest, surest, and most accurate. Superposition equipment that allows plotting directly on the matched map is convenient for this purpose.

Radar Maps.—Radar maps are used in a dim light and with PPI signals superposed on them; usually the scale is small. This limits the

symbols, shading, and coloring which may be used advantageously. Maps used in tactical operations during the war were made in only black and white and had standard symbols and nomenclature. Figure 9-21 shows the symbols most frequently required. Hachures have been found to be more legible than the more conventional contour lines; and the numbers assigned to hills, lighthouses, and other tall targets are the

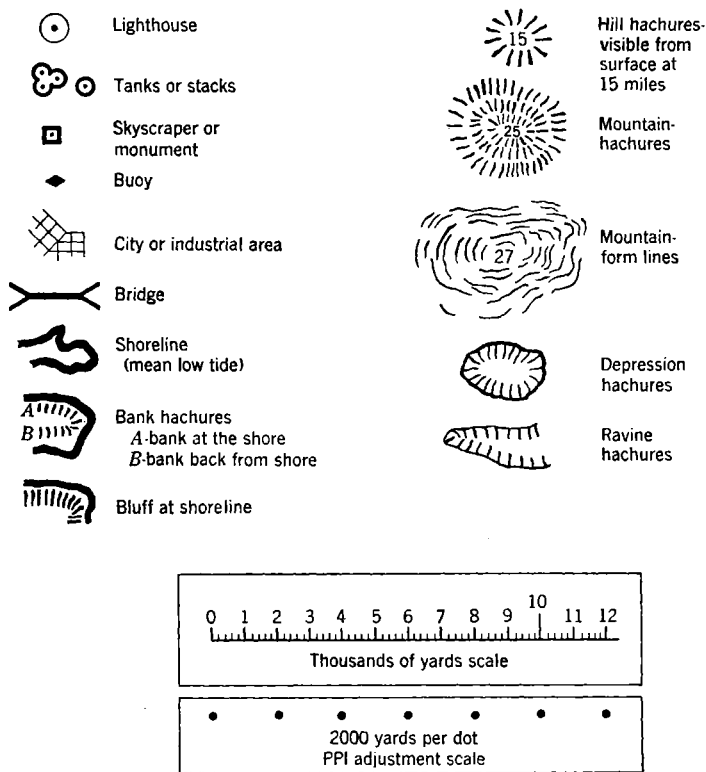

FIG. 9-21.—Symbols commonly used on radar maps.

normal detection ranges in nautical miles (approximately equal numerically to $\sqrt{2h}$, where h is the height in feet) obtained with a radar antenna at zero elevation. The shoreline is drawn for the mean low-water level. Figure 9-22 is a sample radar map of Cape Cod.

Maps which have been used in United States coastal waters are 1:80,000 United States Coast and Geodetic Survey navigation charts and the United States Geological Survey, USGS, topographic maps. Most of the shorelines, etc., are traced full-scale from the more up-to-date Geodetic Survey charts. The USGS maps are then used for filling in

the topographic features, a process made tedious by the difference in scale. At best, maps so prepared show only about one third of the water tanks and stacks, vital shorelines only approximately, and banks lower than 20 ft hardly at all.

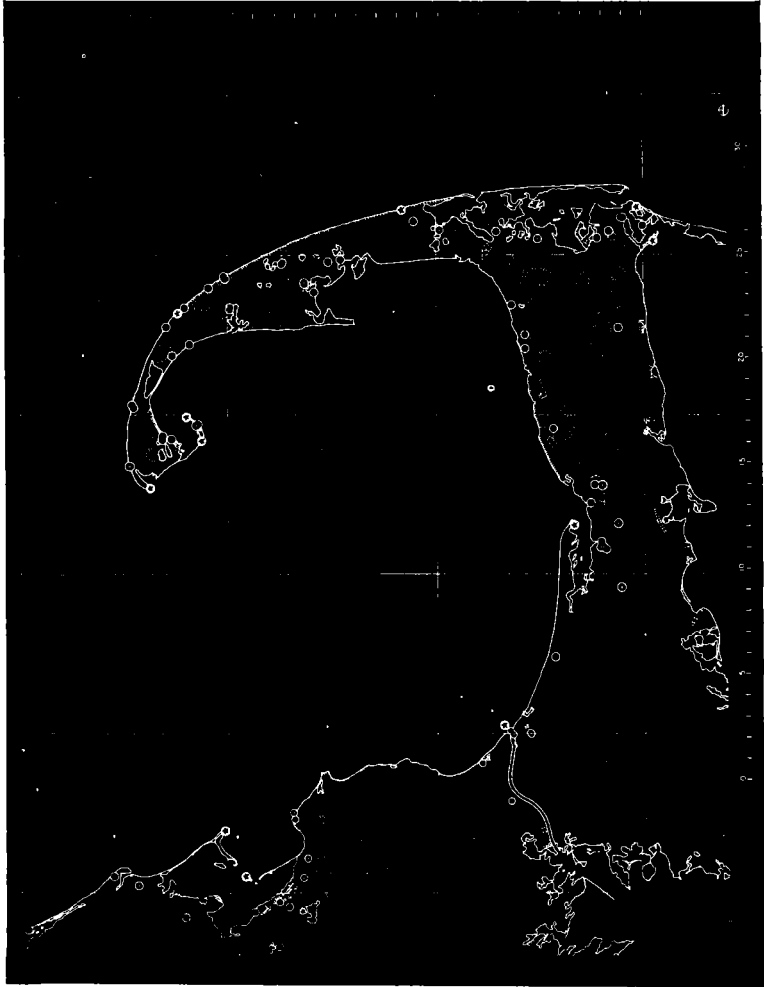

FIG. 9-22.—Radar map of Cape Cod.

In European and Pacific waters, the available charts and maps have been used either in their original form or retraced with suitable symbols. Either black-on-white tracings prepared from this material or the original

maps themselves are copied photographically and printed as negatives (white lines on black) at the proper scale.

The best source of data for these maps is an up-to-date aerial survey with complete stereo-pair coverage, but this would require a large investment in mapping, in terms of the amount gained over maps and charts now in existence. In the future, whenever a coastal survey is revised, aerial photography will undoubtedly be used. It is to be hoped that those in charge will be aware of the requirements of maps for radar uses when they set up their procedures for reducing the photographic material to map form.

The distortion involved in reproducing, on a plane, a section of the curved surface of the earth sets a limit to the size of the region that can be covered by a single radar map. Even for the small regions used thus far, attention must be paid to the type of mapping projections. The United States Coast and Geodetic Survey navigation charts are Mercator projections, which means that the latitude and longitude lines are straight and parallel. Each chart has a scale 1:80,000 in all directions at its mid-latitude. As a result, the features of one chart cannot be brought into exact register with those on the next chart to the north or south.

Conic projections are standard for Geological Survey maps and many others because they represent the surface of the earth more accurately. In the conformal conic projection, parallels of latitude become concentric circles, and meridians of longitude become radial lines. The distortion of a Mercator projection at latitude 50° , with respect to a PPI on an 80-mile sweep, amounts to about ± 1.5 per cent of the sweep length, whereas the corresponding distortion of a conic projection is certainly less than a tenth of that. Nevertheless, for sweeps of 12 miles or less, the distortion of the Mercator charts is not appreciable. Because so many nautical charts are Mercator, the practice in the immediate future will probably be to use them as a basis for radar maps.

Many errors found in charts or maps are due to failure of the chart paper to hold its original dimensions, not to surveying or drafting errors. Absolute scale is not important in charts carrying a scale printed on them, but when a strain in the material causes shrinkage in one direction that is different from that in another direction, the resulting distortion is serious. The dimensional stability of photographic film is adequate for the purpose, but that of printing paper is not. Almost all printing papers are so glossy as to cause glare in the superposition device; but far more serious is their large distortion in processing. Certain kinds of ozalid-type paper, and at least one kind of waterproof print paper, that have adequate stability and no gloss are available. In some forms of superposition equipment the material is reduced to the microfilm size

used in a projector. These films are free from distortion, but there are other practical drawbacks to the microfilm method.

Paper prints are usually prepared in sections that overlap each other. When large maps are required, wide scrolls that roll vertically and are translated horizontally may be made.

Indicator Requirements.—Since accurate adjustment of scale between the map and the PPI must be made by changes in the sweep speed of the PPI, the sweep-length control should be accessible on the front of the indicator. A second control is required to move the beginning of each sweep toward, or away from, the center of rotation. The linearity of modern M-M PPI's is excellent except for a small region at the start of

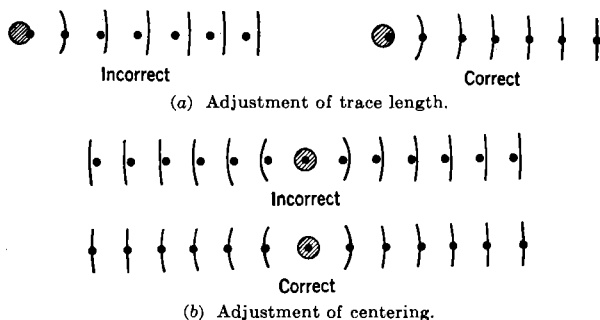

FIG. 9-23.—Adjustment of PPI scale and centering for map-matching. The arcs are segments of range circles of the indicator and the dots represent the scale of the map.

the sweep. For optimum performance, the sweep should be so designed that the nonlinearity at the start is as short as possible. This means that there will be a small but harmless hole in the center of the PPI pattern when it is properly adjusted for mapping. This hole must not be confused with the much larger altitude hole which is normally characteristic of an airborne PPI presentation.

One method of checking the zero error is to measure the ranges to known points when the radar location is known, and then compare the radar results with map measurements. Another method using superposition requires fitting the PPI to a number of map points on all sides of a harbor or bay and making the final adjustment by changing the centering control if necessary. Then, by spanning the PPI with the scale of dots normally used in its adjustment, the centering error of the pips (which is now the zero error of the range markers) can be determined by fitting the dots to one side of the PPI, estimating the misfit (algebraic average) on the other side in fractions of a mile, and dividing by two—since the zero error appears twice in the diameter. This process is illustrated in Fig. 9-23.

The off-center PPI is, unfortunately, rather badly distorted as soon as it is off-centered by more than one tube diameter. A centered M-M PPI, the only known CRT presentation that gives a geometrically precise two-dimensional display, is responsible in large measure for the success and accuracy of the superposition technique. North-stabilized PPI's are far more convenient to use and are more accurate than relative-bearing types. The greatest advantage of the stabilized indicator is that yaw does not interfere with the measurement of angles between signals. An accurately stabilized PPI would completely eliminate rotation as a degree of freedom in map-matching, and this in turn would make it possible to obtain fixes with less radar information on the tube. For this purpose, compasses correct to $\pm 0.5^\circ$ at all times are desirable because an error of 1° in the orientation of the matched map can easily be detected.

Suggested Improvements.—Greater compactness of matching devices is desirable. To this end, a PPI built into the same cabinet with the projector is suggested. The RCP is suitable for a large ship where there is room for such remote indicators, but for general use a smaller instrument is required. A short range sweep (1 or 2 miles) on a cathode-ray tube, which is flat-faced to minimize parallax in superposition and used with the basic VPR, would be a compact and simple arrangement.

Because it is difficult to examine rolls of film in order to find the desired frame, even on a well-indexed roll, it may be desirable to use a separate slide for each chart. More space would be needed for storage but selection of the desired frame could be made more readily than with a roll of film.

The dead-reckoning tracer or odograph resolves the motion of the ship in rectangular coordinates and traces the course on a plotting sheet. This suggests the use of the odograph data for driving the projector screws (or the film-holder screws), thereby keeping the chart matched. To compensate for set and drift, differentials could be inserted between the input of odograph data and the projector drive (or film-holder drive) for each coordinate. The differential component due to set and drift in each coordinate could be determined by the rate of motion required to keep the chart in match with the PPI. Once determined, this rate could be constantly fed into the differential and as long as the rate remained constant, the chart would stay in correct match.

9-8. PPI Simulations.¹—Many attempts have been made to use sets of PPI patterns for navigational purposes. One method of obtaining PPI patterns is to send out an airplane or boat to patrol a desired area and constantly take PPI photographs. Another method of obtaining PPI patterns in advance is the Radar Planning Device (RPD) technique. The RPD is essentially a point source of light fitted for mounting on a

¹ By D. B. McLaughlin.

relief model of a portion of the surface of the earth. Intended originally for determining radar coverage against hostile airplanes, it was found to be extremely valuable for the prediction of PPI patterns and for the preparation of simulated PPI pictures.

The point of light is placed on the relief model at a point corresponding to the position of the radar antenna. Areas that will give signals will be illuminated and other areas will appear dark. A photograph of the model thus illuminated will show spots of light in the positions of the corresponding scope signals. The spread of signals in azimuth can be simulated by copying the picture on a film mounted on an easel that is arranged to rotate about the center of the simulation as the exposure is made. The resulting picture almost perfectly duplicates an actual PPI photograph obtained with a radar situated at the corresponding point on the land or water.

Such simulations have been used in navigation tests, principally by two methods. In the first, the simulation is mounted in the chart position on a VPR which is on a table that can be traversed a short distance in rectangular coordinates. With the simulation centered on the PPI, the adjustable scales of X and Y are set to zero, and the table is traversed until the simulated and the true PPI's are superimposed as exactly as possible. The distance of the ship from the position for which the simulation was prepared can be read on the scales.

The other method makes use of a rectangular grid superimposed on the simulation. The signal patterns of the PPI and the simulation are made to coincide, and the apparent place of the PPI center is read off at once in terms of the rectangular grid.

The application of the RPD technique is limited. To be of use, it requires that the course to be followed must have been chosen well in advance and the simulation prepared from a relief model constructed at the cost of much time and effort. Such cases did arise during the war when invasions were prepared months in advance, but it does not appear feasible to use these techniques for general navigation except in special regions—where a narrow channel is to be negotiated, for example.

The greatest value of RPD for navigation would appear to be in briefing and in the aid it can give the radar operator in showing what topographic features will give signals and what ones will not. This would greatly facilitate recognition of terrain features and identification of signals. If the simulations are used in the VPR, however, they should certainly be a part of the VPR chart. As always, the chart should have the shoreline and the more prominent topographic features marked by their conventional signs, and the simulated scope pattern should merely supplement these chart features. In tests of navigation, by matching simulated PPI's to real signal patterns, the fixes did not attain the degree

of accuracy given by the simple chart-matching procedure that makes use chiefly of a chart on which the shoreline is by far the most important feature.

Both PPI photographs and RPD simulations are sensitive to such factors as variation in atmospheric refraction whereas the accuracy of simple map superposition is not affected. Indeed, the map-superposition method benefits by supernormal propagation in that it is able to obtain fixes at a greater distance from shore.

BIBLIOGRAPHY

PREPARATION OF MAPS

"Preparation of Maps for Use with the VPR," RL Group 102 Report.

MAP-MATCHING TECHNIQUES

"Use of the VPR for Matching a Map to the PPI," RL Group 102 Report.

Miller, E. E. and D. B. McLaughlin, "Precise Navigation by Means of a Radar Map Superposed on the PPI," RL Report No. 503, April 7, 1944.

"A Manual of Radar Recognition," Seventh Progress Board Report NALOC to the Chairman NDRC, May 12, 1944.

VIRTUAL PPI REFLECTOSCOPE, VPR

"Instruction Manual for VPR," Radiation Laboratory, M.I.T., November 1943.

NAVIGATIONAL MICROFILM PROJECTOR, NMP

Fourth Progress Report NALOC to the Chairman NDRC, Feb. 15, 1945.

AUTOFOCUS RADAR PROJECTOR, ARP

McLaughlin, D. B. and C. A. Smith, "A Microfilm Chart Projector for Radar Navigation," RL Report No. 658, January 23, 1945.

RADAR CHART PROJECTOR, RCP

McLaughlin, D. B. and C. A. Smith, "The Radar Chart Projector," RL Report No. 926, 1945.

RADAR PLANNING DEVICE, RPD

"RPD Radar Planning Device (16-c-23)," Conavaer No. 30-160R-28, November, 1944.

"RPD in Surface Navigation," Aer SD-112 FLR Special Devices, Bulletin No. Ds 8.
"B-scope Simulator," Device No. 16-C-23-u, Aer SD-112 FLR Special Devices
Bulletin No. Ds. 9.

MANUAL BEARING UNIT

Smith, C. A., "Preliminary Instructions for the Manual Bearing Unit," RL Report No. M-192, January 9, 1945.

CHAPTER 10

A SHIPBORNE NAVIGATIONAL RADAR

BY J. P. NASH, R. M. EMBERSON, AND R. E. MEAGHER

The problem of designing a shipborne navigational radar is influenced strongly by several factors beyond the designer's direct control. These are the low altitude of both the antenna and targets, the effect of the curvature of the earth, the interference between direct beams and those reflected from the water, and atmospheric refraction. It is fitting, therefore, to begin this chapter with a discussion of radar propagation over water.

10-1. Radar Propagation over Water.¹—The propagation of radar waves over the curved conducting earth is complicated, although there is little reflection of microwave radiation by the ground, and the antenna pattern over land is usually a clean-cut lobe. Over water (and over land with long-wave radar) the situation is more complicated. The problem can be studied as a problem in diffraction by careful analysis with ray-tracing methods near the radar set and in the region below the horizon. A detailed discussion is found in *Propagation of Short Radio Waves and Radar System Engineering*, Vols. 13 and 1, Radiation Laboratory Series. Only enough of the theory to give the reader a feeling for what goes on outside the shipborne radar set is presented here so that he may understand more fully the nature of the problems that arise and how proper radar design can solve them.

Before studying the contribution of the surface of the ocean to the behavior of radar waves after they leave the antenna, the so-called "free-space" case, in which the radar set and its target are supposed to be in an otherwise empty space, should be reexamined. In Sec. 1-3 it was pointed out that in free space the dependence of range upon other factors can be expressed by the equation

$$R_{\max} = \left(\frac{\sigma P_t A^2}{32 S_{\min} \lambda^2} \right)^{1/4} = 0.42 \left(\frac{P_t \sigma}{S_{\min}} \right)^{1/4} \left(\frac{A}{\lambda} \right)^{1/2}. \quad (1)$$

It is apparent that the free-space range varies inversely as the square root of the wavelength if all other quantities in Eq. (1) are held fixed. That is, in two radar sets for which all quantities of Eq. (1) except λ

¹ J. P. Nash.

are the same, one of which has a wavelength of 10 cm and the other a wavelength of 40 cm, it is clear that the 10-cm set gets twice the range of the 40-cm set. This increase of range, however, comes from a greater concentration of energy by the 10-cm set, caused by a narrowing of the radar beam. The 40-cm set will have the same range if the area of the antenna A is increased by a factor of 4. Because this dependence on wavelength is actually a dependence on the ratio of the wavelength to the area of the aperture, the quantity A/λ should be held fixed to determine what happens outside of the radar set when the wavelength is changed. In this way the wavelength factors associated with overwater propagation phenomena are separated from those related to the free-space range of the set.

The most important aspects of the problem are brought out by assuming that the earth is flat within the horizon circle of the radar antenna

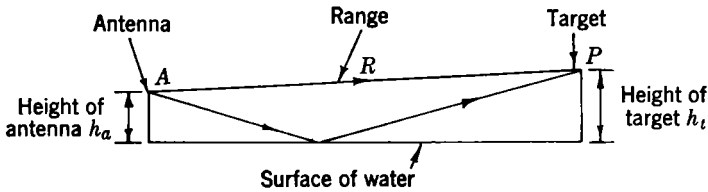

FIG. 10-1.—Diagram showing paths of energy from radar antenna to and from the target.

and that the surface of the ocean reflects radar energy perfectly, so that all of the energy striking the water continues on its way after being reflected. These two assumptions, a flat surface and 100 per cent reflection, greatly simplify the problem and permit the derivation of theoretical results of practical value. The approximation, as a matter of fact, is not bad with horizontally polarized 10-cm radiation. The theoretical value of the reflection coefficient for a smooth sea is 95 per cent for a grazing angle of 0.5° and 85 per cent for an angle of 2° . The actual value of the coefficient is subject to rapid fluctuations about the average value.

What happens if a radar antenna at height h_a sends energy out over a perfectly reflecting flat surface? As indicated in Fig. 10-1, a point P at height h_t in space will receive energy that travels along two different paths, one a straight line and the other an indirect path by way of the reflecting surface. The amplitude will vary from point to point because of the difference in phase introduced by the two path lengths. If h_a and h_t are small relative to R , the amount of energy going by one path can be assumed to be the same as that going by the other.

It can be shown, assuming a phase shift of 180° upon reflection from the water, that if a radar set has a pulse power output of P_t watts, an

antenna of area A and a wavelength λ , the power flow per unit area S at the point P is given by

$$S = \frac{P_t G}{4\pi R^2} 4 \sin^2 \left[\frac{2\pi h_a h_t}{\lambda R} \right] \quad (2)$$

when h_a and h_t are small compared with R . The value of the antenna gain $G = KA/\lambda^2$.

This discussion applies only to radar propagation inside the circle of the horizon. This space can be divided vertically into two regions. The first, the surface region, is immediately adjacent to the water where the targets of greatest interest to shipborne radar lie. A special range equation applies to this surface region. The second region, the lobe region, lies above the first.

Lobe Region.—It is more convenient to discuss the lobe region first. Because of the sine-squared factor in Eq. (2), at a fixed range the value of S can be made to vary between zero and a maximum of $P_t G/\pi R^2$ by

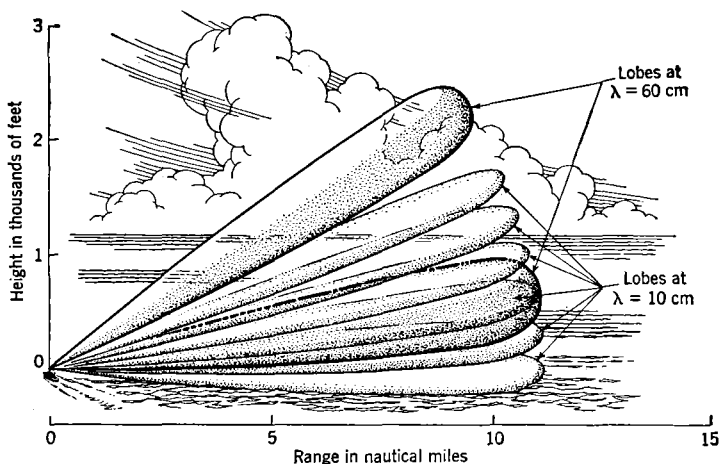

FIG. 10-2.—Lobe structure for 10-cm and 60-cm radiation over a flat reflecting surface.

varying the values of λ , h_a , and h_t . Maxima occur when the angle is an odd multiple of $\pi/2$, the first maximum appearing when

$$\frac{h_t}{R} = \frac{\lambda}{4h_a} \quad (3)$$

But h_t/R , to a good approximation, is the elevation angle of P from the transmitting antenna. Hence, the elevation angle of the first maximum above the water is $\lambda/4h_a$ radians, that of the second is $3\lambda/4h_a$, etc. In a similar manner, minima at $\lambda/2h_a$, $2\lambda/2h_a$ are found. The field distribution in space consists, then, of a number of lobes, with a maximum

intensity along the center line of each lobe. The lobes are separated by regions of low intensity. If the two assumptions above were correct, the intensity would be zero, theoretically, midway between two adjacent lobe maxima.

Figure 10-2 shows the lobe structure above a flat reflecting surface for two radar sets operating on wavelengths of 10 and 60 cm and with antennas 30 ft high. A good 10-cm radar set with a pulse power output of about 20 kw and an antenna area of about 2 ft² should detect a large airplane along these contours. The surface region for 10 cm is indicated. It is important to notice that the lobe structure is much finer for the 10-cm than for the 60-cm radiation and that there are six times as many lobes at the shorter wavelengths. They also increase in number as the antenna is raised.

Surface Region.—The surface region lies beneath the lowest lobe. It is more important to the navigator because its position determines the radar coverage near the water. From Eq. (3), which defines the position of the lowest lobe, it is clear that targets are in or above the lowest lobe if

$$R \leq \frac{4h_a h_t}{\lambda} \quad (4)$$

and are in the surface region if R is greater than this value. For targets that are at a reasonable distance the angle of Eq. (2) is small and the sine may be replaced by the angle. If $h_a = 30$ ft, $h_t = 20$ ft, and

$$\lambda = 10 \text{ cm} = \frac{1}{3} \text{ ft},$$

the surface region is more than 2400 yd away. If there is a point target of radar cross section σ at P (Fig. 10-1) and if the minimum detectable signal of the radar set is S_{\min} , it can then be shown from Eq. (2) that

$$R = 2.6 \left(\frac{P_t \sigma}{S_{\min} 4\pi} \right)^{1/8} \left(\frac{A}{\lambda} \right)^{1/4} \left(\frac{h_a h_t}{\lambda} \right)^{1/2} \quad (5)$$

This equation has been called the "eighth-power range formula" because range varies as the eighth root of the transmitted or received power rather than as the fourth root in free space [see Eq. (1)]. Equation (5) is valid only for a point target in the surface region (a region often referred to as the "eighth-power region").

As an example of the use of Eq. (5), let us calculate the maximum range at which a small cabin cruiser can be detected with a radar set mounted 40 ft above the water, assuming that the cruiser can be treated as a point target. Let us assume that $P_t = 20$ kw at 3 cm, that $P_t/S_{\min} = 2 \times 10^{15}$, and A is 1.3 ft² or 0.8 ft² when an efficiency factor 0.6 is used. A reasonable value for the radar cross section σ of the target is 70 ft², and

a good target height to assume for a small cabin cruiser is 10 ft. A substitution of these quantities into Eq. (5) gives $R = 27,000$ ft or about 9000 yd. It must be emphasized that this value of R is based upon a flat-earth approximation and upon the assumption of a point target and cannot be relied upon as an exact value. It does, however, give the proper order of magnitude for the expected maximum range on a cabin cruiser when conditions of standard refraction exist.

Table 10-1 gives some experimentally determined values¹ of heights and radar cross sections of several kinds of vessels. The values given were derived from data obtained with 3-cm equipment. Because the dependence on wavelength is small, the heights and cross sections are applicable for most microwave frequencies and low antenna heights.

TABLE 10-1.—EFFECTIVE HEIGHTS AND RADAR CROSS SECTIONS FOR SEVERAL SURFACE VESSELS

Target	Effective height, h_e , ft	Radar cross section, ft ²
Low cabin cruiser about 40 ft long	10	70
Tanker	30	24,000
Large freighter	60	80,000
U. S. Navy cruiser	100	150,000

We have given in the preceding paragraphs some equations that reveal the general nature of the behavior of radar energy over water. The conclusions which may be drawn from this discussion are as follows:

1. *In the lobe region, because of reflection from the water, ranges on targets (such as aircraft) at the centers of the lobes may be increased over the free-space values by nearly a factor of 2. Also, in the same region, the range on similar targets between the lobes will be much less than the free-space range.*

This can be seen by setting the sine-squared term in Eq. (2) equal to unity and comparing the resulting expression for S with

$$P = \frac{P_i G}{4\pi R^2}$$

given in Sec. 1-3. Since four times the power is present at point P , 16 times as much power returns to the radar antenna. Since the range (in the lobe or free-space region) varies as the fourth root of the power, it is apparent that the range in this case is doubled.

¹O. J. Baltzer, V. A. Counter, W. M. Fairbank, W. O. Gordy, E. L. Hudspeth, "Overwater Observations at X and S Frequencies on Surface Targets," RL Report No. 401, July 26, 1943.

In actual practice the roundness of the earth and the imperfect conductivity and roughness of sea water make the range increase less than a factor of 2 for microwaves, but ranges approaching the doubled value have been observed. Also, since there is no way of getting extra power for nothing, the range on an airplane midway between two lobes, although theoretically zero, is actually very greatly reduced from the free-space value.

2. *Other factors being equal, the best radar coverage over water is given by short wavelengths.* This is immediately apparent from Eq. (3) because the elevation angle of the lowest lobe varies directly with the wavelength. Figure 10-2 shows this clearly. A quantitative idea of the advantage of short wavelengths is obtainable from Eq. (5). The fourth-root term involving A/λ is ignored since it was assumed that this factor was held constant in comparing one set with another. From the square-root factor $(h_a h_t / \lambda)^{1/2}$, it is seen that the range in the surface region varies inversely as the square root of the wavelength. This means that if the free-space ranges of a 10-cm and a 40-cm radar were equal, the 10-cm system would have twice the range of a 40-cm radar set on targets in the surface region.

Equation (5) also shows that the range in the surface region is directly proportional to the square root of the product of h_a and h_t . Since the height of the target is beyond the control of the radar designer he must content himself by mounting the radar antenna as high as is practical. An antenna mounted at a height of 40 ft will give twice the surface range of the same antenna when only 10 ft above the water.

For point targets like corner reflectors, the square-root relationship between R and h_t has been confirmed experimentally. For larger targets like ships an "effective height" must be used to calculate ranges. Its determination would be relatively simple if it were not for the presence of the unknown value of σ which also appears in Eq. (5). When a target moves out of the lowest lobe and into the surface region, the returned energy no longer obeys an inverse fourth-power law, but follows an inverse eighth power, as given by Eq. (5). Hence, it is possible to determine experimentally the range at this point of transition and to calculate an effective height from Eq. (4); σ can then be found from Eq. (5). The values given in Table 10-1 were obtained in this way.

3. *Intensity of energy in the surface region is low.* Since range varies as the eighth root of the output power for targets in the surface region, this power must theoretically be increased 256 times in order to double the range. In practice the figure may even be

higher than this. The free-space factor for doubling the range is only 16. This means that maximum ranges in the surface region are much lower than in free space for the same power and target size. It also means that for targets in the surface region, changes in power have a much smaller effect upon range than they do in free space.

Nonstandard Propagation.—The above discussion of the structure of the composite radiation pattern caused by the interference between the direct and reflected beams has been based on the assumption of a flat earth and 100 per cent reflection from the water. In Sec. 1-4 it was stated that the distance to the radar horizon for microwave energy is normally 14 per cent greater than the geometrical value. The energy is sometimes refracted nonuniformly, however, in such a way that surface detection ranges many times greater than those ordinarily achieved result. It is also possible for the reverse to happen, in which event ranges of less than the expected values will be obtained. Since decreases in range occur much less frequently than increases, a prolonged period of substandard ranges usually means that the radar set is not performing as it should. Extensive studies have been made of the causes of nonstandard propagation, and a more detailed discussion of the subject will be found in Vol. 13, Chaps. 3 and 4, of this series.

The atmospheric conditions that cause nonstandard propagation usually occur within a few hundred feet of the surface of the earth, although higher layers are sometimes of considerable importance. Unless the radar energy is directed almost parallel to such a layer, it is affected very little. Consequently, airborne radar sets are not affected by nonstandard propagation phenomena unless the aircraft are flying very low. Aboard ship, these effects are important because the antennas are low. It is possible, by means of temperature and humidity measurements over a range of heights, to determine whether or not a trapping condition exists at a given time, but the problem is so complicated that reliable *prediction* of periods of nonstandard propagation is not yet possible.

Low-level ducts that guide microwave energy in such a way as to permit the detection of objects at great distances below the horizon are a common occurrence. Under some conditions, the ranges for detection of surface targets can be extended by reducing the height of the radar antenna, but these low ducts do not occur often enough to warrant moving the antenna down. In periods when the duct does not exist or is very weak, lowering the antenna causes a loss in range.

Very strong trapping of the shortest wavelengths in surface ducts is likely to occur only near large land masses. The longer wavelengths may be affected similarly both near to and far from land because of elevated regions of nonstandard refraction as well as surface ducts.

Measurements have been made over a 36-mile one-way path along the coast of Massachusetts with a transmitter at 100 ft and receivers at 30 and 130 ft, together with simultaneous meteorological and radar observations, for the purpose of studying the details of the mechanism underlying nonstandard propagation. It was found that during the fall and summer "standard signal"¹ was the exception rather than the rule for microwaves. Owing to the types of atmospheric conditions that exist when there is warm dry air over water, one-way signals from 1000 to 100,000 times (30 to 50 db above) the standard signal level occurred with equal frequency at 3 cm and at 10 cm.

On the other hand, when the air was colder than the water, 3-cm radio waves were affected more than 10-cm waves, although both were affected less than previously. Signals at both wavelengths increased in power from 10 to 1000 times (10 to 30 db above) the standard. The 3-cm signal was strong more often than the 10-cm, and it usually was higher above the standard level. During these periods radar ranges on surface targets were extended by as much as 25 per cent above normal.

Substandard conditions were present when the air was warm and moist, and they sometimes existed for several days at a time. The reduction in radar ranges on surface targets which accompanied substandard conditions did not markedly change with wavelength.

Results of these experiments showed variations in one-way received power by a factor of more than one billion, or 90 db, and the radar ranges on random surface targets varied from approximately 10 miles up to 240 miles.

The following table gives the observed data. It should be emphasized that these data refer only to this particular transmission circuit, time, and location.

TABLE 10-2.—STATISTICS OF S- AND X-BAND TRANSMISSION IN SUMMER, 1944, ALONG THE NEW ENGLAND COAST

Date	λ , cm	Per cent of time above standard	Per cent of time standard	Per cent of time substandard
July 10-16.....	..	63	1	36
Aug. 21-27.....	..	97	0	3
Aug. 28-Sept. 3.....	..	80	5	15
Sept. 25-Oct. 1.....	10	58	27	15
	3	80	20	10
Oct. 16-22.....	10	76	22	2
	3	92	8	0

¹ Standard signal level is defined as the "signal level at the receiving antenna computed for an earth's radius assumed to be $\frac{2}{3}$ the true radius," i.e., for standard refraction.

An example of unusual atmospheric refraction is shown in Fig. 10-3. The ship is 30 miles east and slightly north of Cape Charles, Va. The sweep length is 100 nautical miles. The echoes from 0 to 100 miles at a bearing 30° east of north are reflected from Long Island and the Connecticut and Rhode Island coasts on third sweeps of the PPI.

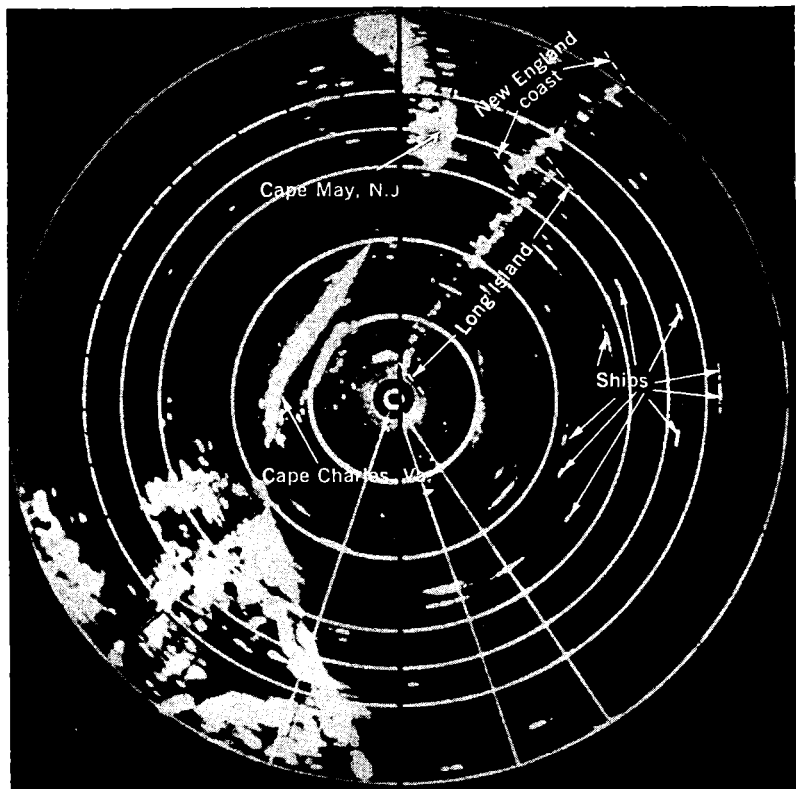

FIG. 10-3.—An example of nonstandard propagation. The signals at bearing 30° extending from the center to the edge of the picture are between 200 and 300 nautical miles distant.

Since these signals are, in effect, delayed 200 miles, a considerable amount of distortion results. Signals from the Rhode Island and Cape Cod coasts were visible at the time of this photograph on the second sweep of another indicator when a 200-mile sweep was used. These signals represent targets between 275 and 345 nautical miles away.

An extreme case of anomalous propagation has occurred over the Indian Ocean. Echoes from the coast of Arabia have been seen from the west coast of India, a distance of 1200 miles.

In general, 3-cm energy from low antennas is more likely to be trapped and guided along the surface than is 10-cm radiation. Other things being equal, then, a 3-cm set is likely to give better surface coverage than a 10-cm set when its antenna is mounted at the same height, for in addition to the low-cover advantage obtained from the shorter wavelength under standard propagation conditions, there is the added possibility of radiation trapping.

Propagation over land is also affected by nonstandard refraction, but in this case the effects are even more complicated. Periods of nonstandard refraction usually occur at night; one of the principal results is an increase in ground clutter caused by guiding of energy near the surface of the earth.

It has been suggested that there may be refraction effects that will cause the rays to bend appreciably in the horizontal plane, giving rise to possibly erroneous bearing information. The small amount of information now available (obtained over land, which may possibly exaggerate the effect) indicates that an extreme value for such bending is about 0.1° . It is, at any rate, too small to measure very accurately. Bending in the vertical plane may be somewhat larger, according to the small amount of information available.

10-2. General Specifications of a Shipborne Navigational Radar.¹—

Although the basic electronic circuits in a shipborne radar may be identical with those used in airborne or ground radars, the operating conditions and requirements peculiar to shipborne equipment are probably more severe. Ship equipment must operate dependably for several weeks at a time. It must be designed to withstand continuous vibration and high humidity coupled with the highly corrosive action of salt air, and to operate in spite of large voltage fluctuations in the power supply of the ship.

The simplest radars are designed as a single unit. Any departure from this construction increases the complexity of the system. On the other hand, if a number of units are used, only the indicators need be installed on the bridge or at other already crowded stations. A surface-search radar may be conveniently designed in four units: an antenna assembly, a transmitter-receiver or r-f package, an indicator and control package, and a power-supply package.

Before a radar set is designed for use on a ship it must be decided whether the set is to interrogate beacons. If beacons are to be used, either with or without interrogation coding, they and the radar set must be designed together as components of a more comprehensive system. Beacons designed as an afterthought have never been completely satisfactory. It must be decided, in particular, whether the radar traffic is

¹ Sections 10-2 to end of chapter by R. M. Emberson and R. E. Meagher.

likely to be so dense that interrogation coding for beacons will be needed; the design of the modulator will depend on the decision. Also, the desirability of rapid switching between reception of beacons and echoes, and of automatic control of the tuning for reception of beacons must be judged, and the receiver designed accordingly. The special requirements to be incorporated into a radar that is to operate with beacons have been given in Sec. 9-3. AN/APS-10 was designed and built to operate with beacons. It is not necessary to discuss this aspect of the problem explicitly here since it is discussed in Sec. 6-3.

The general specifications are as follows:

Antenna: Horizontal beamwidth 2° or less; vertical beamwidth 15° . In the horizontal plane, the secondary side lobes less than $\frac{1}{1000}$ of the central beam intensity at all angles more than three beamwidths (6°) from the axis. Scan rate approximately 6 rpm.

Transmitter: at 3.25 cm, with 50-kw pulse power and $\frac{1}{4}$ - μ sec pulses; repetition rate 1000 cps.

Receiver: noise figure no more than 15 db below the value theoretically possible; 6- to 8-Mc/sec bandwidth with a 30-Mc/sec i-f amplifier. Video channels in the receiver and indicator should be at least 6 Mc/sec wide.

Indicator: 12-in. PPI, with 2-, 10-, 20-, and 40-mile sweeps. Angular accuracy to be better than 2° , with a lag of less than 0.5° and a "jitter" of less than 0.05° . Accuracy of range markers to be better than 1.5 per cent of the indicated amount.

10-3. Antenna Assembly.—The most common radiation pattern of a radar antenna is a beam widened in one direction rather than a symmetrical pencil beam with a circular cross section. Shipborne radar intended solely for navigation and pilotage ideally should have the sharpest possible pencil beam to provide the greatest resolution in azimuth and the maximum detection ranges. The relationship between resolution and beamwidth is illustrated by Fig. 10-4. The rolling and pitching of a ship, however, make the utilization of a sharp beam impractical. Stabilization problems are discussed in connection with airborne radar in Sec. 5-4 and in more detail elsewhere in this series.¹ Aspects of the problem particularly pertinent to shipborne radars are briefly treated here.

Deck-tilt Errors.—The use of an unstabilized fanned radar beam can introduce appreciable azimuth or deck-tilt errors for certain relative bearings. This is easily understood if one considers first a radar antenna turned to a target located at 270° relative bearing, i.e., on the port beam. Let us assume that the ship does not pitch. Then, as the ship rolls the vertically fanned beam will sweep up and down across the target, but

¹ *Radar System Engineering*, Vol. 1, Chap. 9; *Radar Scanners and Radomes*, Vol. 26, Chaps. 4 and 7.

will always point correctly in bearing. Consider now the same conditions (i.e., roll only of the ship) with the target just off the port bow, for example at a relative bearing of 340° . If the antenna is properly pointed at the

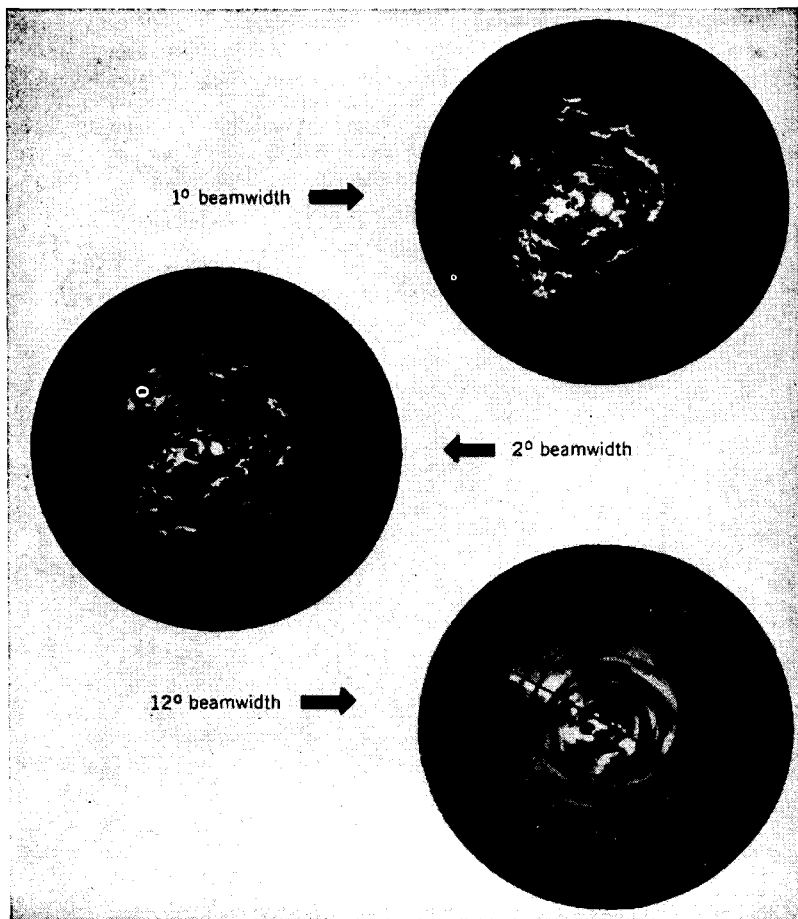

FIG. 10-4.—Three PPI photographs taken from three different radars from the same position (near Governor's Island) in Boston Harbor.

target when the ship is on an even keel, the roll of ship to port will make the beam pass to the port side of the target and the bearing of the antenna will have to be changed, to 343° , for example, in order to bear on the target. Similar deck-tilt errors can be caused by pitching of the ship or, of course, by the combination of roll and pitch.

Table 10-3 gives an idea of the magnitude of the deck-tilt errors to be expected for various degrees of roll and pitch. The errors vary in both magnitude and sign in a complicated manner. There is symmetry, however, between starboard and port bearings and between positive and negative roll and pitch angles. Although deck-tilt errors may be as large as several degrees, actually they are not troublesome in simple navigational operations unless the antenna scan is exactly synchronized

TABLE 10-3.—DECK-TILT ERRORS POSSIBLE WITH VERTICALLY FANNED BEAM OR LINE-OF-SIGHT STABILIZATION*

δ = true bearing
 δ' = apparent bearing
 P = pitch angle
 R = roll angle

(a) GENERAL TABLE OF DECK-TILT ERRORS, $\delta - \delta'$

δ'	$P = 0$				$P = 7\frac{1}{2}^\circ$				$P = 15^\circ$			
	$R = 10^\circ$	$R = 20^\circ$	$R = 30^\circ$	$R = 45^\circ$	$R = 0^\circ$	$R = 10^\circ$	$R = 20^\circ$	$R = 30^\circ$	$R = 0^\circ$	$R = 10^\circ$	$R = 20^\circ$	$R = 30^\circ$
0	0	0	0	0	0	-1.3°	-2.7°	-4.3°	0	-2.6°	-5.4°	-8.5°
15°	+0.2°	0.8°	2.2°	5.7°	-0.1°	-1.1°	-1.8°	-2.0°	-0.5°	-2.7	-4.7	-6.5
30°	+0.4	1.6	3.7	9.2	-0.2	-0.8	-0.7	+0.4	-0.8	-2.5	-3.5	-3.7
45°	+0.4	1.8	4.1	9.7	-0.2	-0.5	0.2	+1.9	-1.0	-1.9	-2.0	-1.0
60°	+0.4	1.5	3.4	7.8	-0.2	-0.2	0.7	+2.3	-0.9	-1.2	-0.7	0.7
75°	+0.2	0.9	1.9	4.2	-0.1	0.0	0.6	+1.6	-0.5	-0.5	0.0	1.0
90°	0.0	0.0	0	0	0.0	0.0	0.0	0.0	0.0	0.0	0.0	0.0
105°	-0.2	-0.9	-1.9	-4.2	0.1	-0.2	-0.9	-2.0	0.5	0.1	-0.7	-1.9
120°	-0.4	-1.5	-3.4	-7.8	0.2	-0.5	-1.9	-4.1	0.9	-0.2	-1.9	-4.3
135°	-0.4	-1.8	-4.1	-9.7	0.2	-0.8	-2.8	-5.7	1.0	-0.8	-3.3	-6.7
150°	-0.4	-1.6	-3.7	-9.2	0.2	-1.1	-3.3	-6.4	0.8	-1.5	-4.5	-8.4
165°	-0.2	-0.8	-2.2	-5.7	0.1	-1.3	-3.3	-5.9	0.5	-2.1	-5.3	-9.1
180°	0.0	0.0	0.0	0.0	0.0	-1.3	-2.7	-4.3	0.0	-2.6	-5.4	-8.5

(b) BEARING† AND VALUE OF MAXIMUM ERROR

Roll \ Pitch		Roll				
		0°	10°	20°	30°	45°
0°	Bearing.....		44.8°, 136.2°	44.1°, 135.9°	42.9°, 137.1°	40.1°, 139.9°
	Max. error.....		±0.4°	±1.8°	±4.1°	±9.9°
7½°	Bearing.....	45.1°, 134.9°	172.8°	157.1°	151.9°	
	Max. error.....	±0.2°	-1.5°	-3.3°	-6.1°	
15°	Bearing.....	45.5°, 134.5°	12.7°	174.5°	165.7°	
	Max. error.....	±1.0°	-2.7°	-5.4°	-9.1°	

* Data computed by Dr. H. M. James, RL Personal Communication.

† Bearing represents bearing at which deck-tilt errors are maximum.

with the roll and pitch of the ship. Then each target will be shown with the same deck-tilt error on each rotation of the antenna. Ordinarily no such synchronization will exist and the apparent target position on

the PPI, which is a time-average of several scans, will be close to the true bearing.

Radar Azimuthal Errors.—There is an entirely different source of the azimuthal error which appears only under very special conditions; its magnitude may be compared to small deck-tilt errors.

If the target is a large complicated structure like a nearby ship, the echo that reaches the radar is a composite wavefront made up of components contributed by the various parts of the target. If one part is

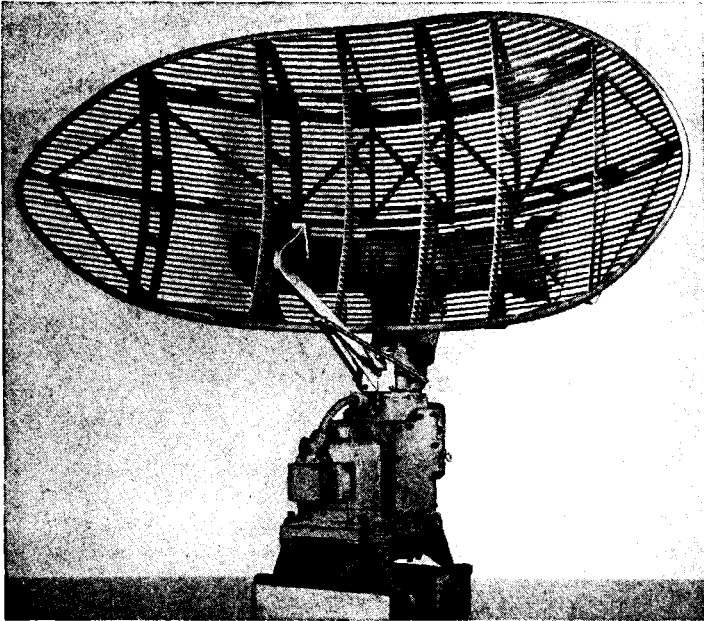

FIG. 10-5.—Photograph of line-of-sight antenna mount.

nearer the radar than another, the reflected energy may be out of phase and the apparent direction of the ship may be slightly changed. Since there is no reason to suspect that such apparent shifts would be synchronized with the rotational speed of the antenna, however, this error can be ignored for all practical purposes.

Stabilization.—The azimuthal axis of a radar antenna can be maintained in a vertical position to within 1° by one of several types of stabilization. The simplest of these, in principle at least, is line-of-sight. As the name implies, it operates either with the reflector or feed or both, movable in what is nominally the vertical plane. A servomechanism (Sec. 1-7) coupled to a stable control element then serves to keep the axis

of the beam directed to the horizon. Deck-tilt errors will be present, however, unless a suitable computer is combined with the stable element to feed compensating elevation and azimuth angle corrections into the servomechanism. Figure 10-5 shows a line-of-sight antenna mount with two axes for a 3-cm radar. One axis, the more complicated vertical axis, permits azimuthal motion. It has a waveguide rotary joint for transmission of the r-f energy, and a number of slip rings and brushes to

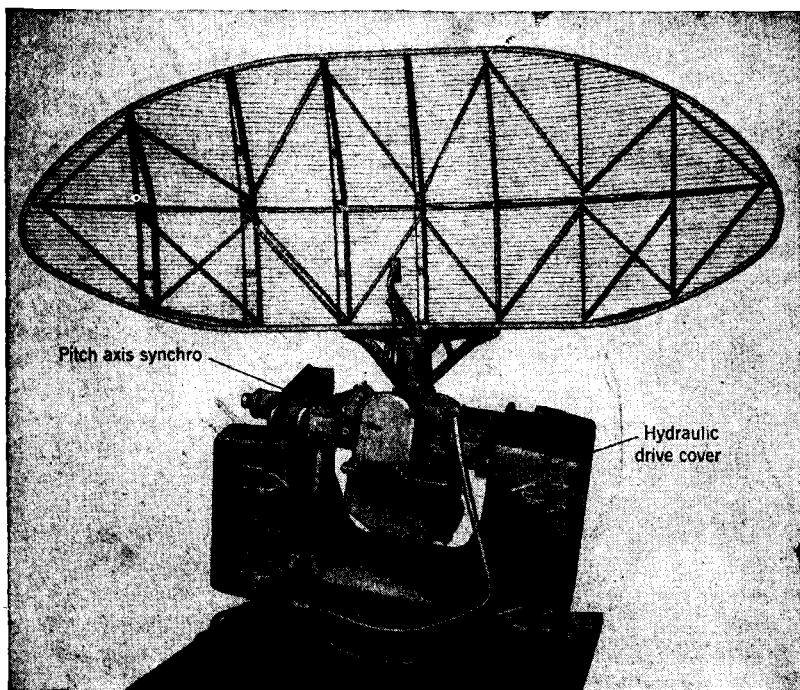

FIG. 10-6.—Photograph of stable-base antenna mount.

provide the various signal voltages and power required to operate the servomechanism. The second, or elevation axis, is contained, along with the associated servomechanism, in the large housing just behind the reflector. In the design used here, the reflector is the only component that moves in elevation.

Another type of stabilized antenna used with surface-search radars is the stable-base mount shown in Fig. 10-6. Basically, it consists of a small platform, stabilized about two horizontal axes, one parallel and the other perpendicular to the keel of the ship. On this always-level base is placed the antenna mount proper. Because the rotational axis of the

antenna is never tilted, the axis of the radiated beam will always point towards the horizon.

A stable-base mount permits the use of a sharp, high-gain beam and is free from deck-tilt errors. This is of particular importance if it is desirable to have a high rate of scan, for the correcting accelerations for an equivalent line-of-sight mount would put too great a demand on the servomechanism. The principal disadvantage of the stable-base mount are the greater topside weight and the additional r-f line and rotary joints that are needed to accommodate the two stabilization axes.

As an alternative to antenna stabilization, the beam may be widened in the vertical plane. The pattern is fanned symmetrically above and below the beam axis, which is a radical departure from the shaping procedure used for airborne and ground-based radars in which most of the widening is done on only one side of the beam. The amount of fanning is usually such that the half-power point of the beam will be on the horizon when the ship reaches its maximum roll in a moderately rough sea. The Navy has found a vertical beamwidth of 15° to be practical for ships of 5000 tons or more.

Since antennas are usually mounted very high on a ship, where substantial weight seriously affects its stability, the simplest and lightest antenna—a fan-beam unstabilized mount—should be used. The model shown in Fig. 10-7 was designed for use at 3-cm, and has a truncated parabolic reflector. It produces a beamwidth of 2° and 7° in the horizontal and vertical planes, respectively. If, however, maximum ranges are required and random deck-tilt errors cannot be tolerated, some other mount will have to be used.

A navigational radar might be equipped with a mount somewhat similar to that shown in Fig. 10-7 but with the beam fanned out more in the vertical plane to provide a beamwidth of 15° . To attain this amount of fanning, and at the same time to provide the narrow horizontal beamwidth, requires a different arrangement from the familiar parabolic section for a reflector with a simple antenna feed. Since it is the *effective* aperture that determines the beamwidth, the following equipment can be used: (1) a section of parabolic cylinder, 60 in. across the horizontal width and 18 in. high; (2) a horn feed, approximately $\frac{1}{2}$ in. wide horizontally but flared to a vertical width of $5\frac{1}{2}$ in. which gives a primary pattern with a vertical width of 15° . Because the reflector is not curved in the vertical plane, radiation from the feed will be reflected with the vertical beamwidth unaltered. On the other hand, the $\frac{1}{2}$ -in. aperture of the feed will give a very broad horizontal beamwidth sufficient to illuminate the entire 60-in. horizontal aperture of the reflector. Since the reflector is parabolic in the horizontal plane, the resultant horizontal beamwidth will be less than the specified 2° .

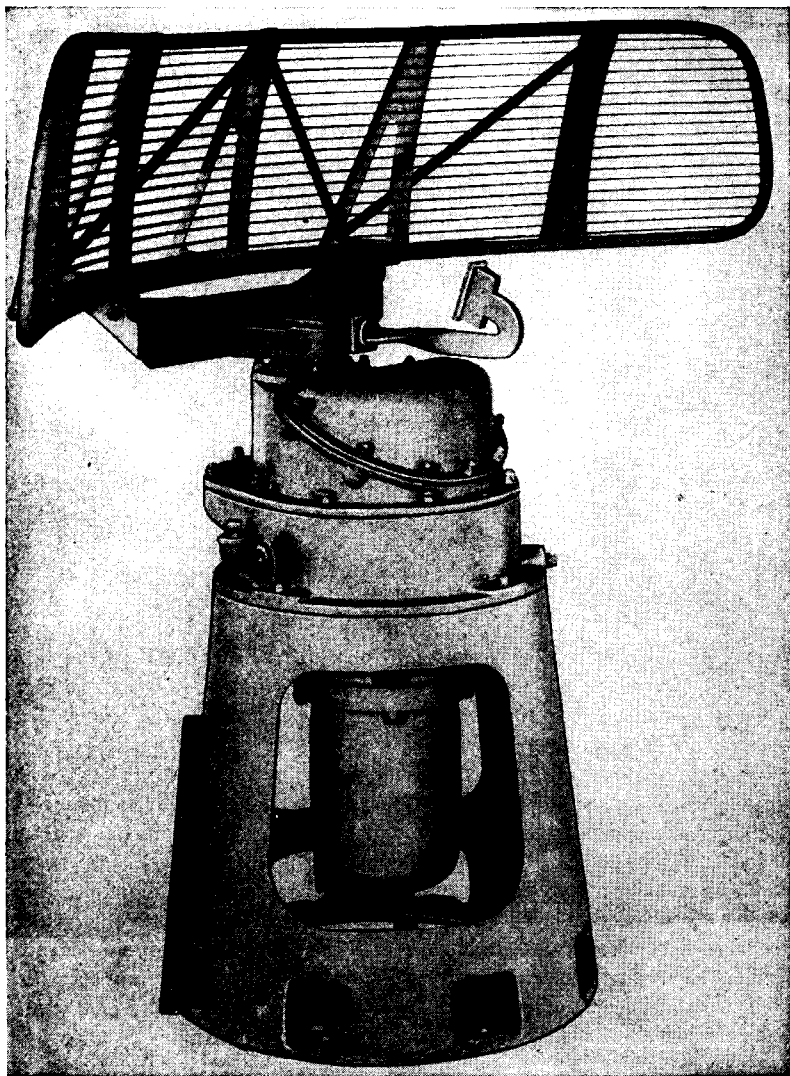

FIG. 10-7.—Unstabilized antenna mount. Beam fanned in vertical plane.

A scan rate of 6 rpm will help simplify the design of the antenna assembly as well as the servomechanism linkage between the antenna and the indicator. This rate is fast enough to permit the operator to view the PPI indicator as a whole. A slower rate would force him to adopt the tiresome procedure of continually following the sweep around the tube.

A switch should be attached to the antenna mount in such a way that a voltage is generated each time the antenna passes a position dead ahead. This voltage, by intensifying a sweep on the PPI, indicates the ship's heading.

10-4. Transmitter-receiver Package.—The transmitter-receiver package can be subdivided into two sections. One contains the transmitting components, that is, the transmitting tube and the high-voltage pulse-forming modulator that drives it. The other section contains the radar receiver and the beacon receiver. If the relatively simple and compact hydrogen-thyratron modulator is used, the interval between successive pulses can be made constant, an important consideration for certain types of recently developed anticlutter circuits. The modulator can be installed in one of two locations. In early practice the modulator proper was placed below deck and the output pulse was transmitted through a suitable high-voltage cable up the mast at an intermediate voltage level. At the top of the mast the voltage pulse was passed through a pulse transformer that raised its value to the high level needed for driving the transmitting tube. The alternative, and the one suggested here, is to place the modulator very close to the transmitting tube.

When the radar must operate at the greatest possible ranges, as in the detection of aircraft during the war, the amount of waveguide between the transmitting tube and the antenna should be kept to a minimum. For navigational radar, on the other hand, surface targets, for which the maximum detection range is limited by the horizon, are of primary interest. The specifications given for the output power and the receiver sensitivity are more than ample to ensure the detection of a target out to the horizon limit and to allow for some superfluous losses in transmission of the r-f energy. The transmitter and receiver can therefore be mounted below deck where they will receive the proper maintenance. Of the four major units in the radar system, this one particularly must be well shielded and grounded to reduce possible interference from nearby communication radio sets. The problem of noise elimination here is very similar to that discussed in connection with airborne radar in Sec. 6 2.

Since the navigational radar will use fairly short sweeps, a high repetition rate may be used, limited only by the power capacity of the transmitting tube. A 1000-cps rate and a $\frac{1}{4}$ - μ sec pulse will not put too much of a strain on the transmitter, and at the same time the number of pulses that hit the target during each scan will be large enough to give good results. A pulse length shorter than $\frac{1}{4}$ μ sec would permit better resolution in range but it would require the addition of unnecessary complexities in both the transmitter and receiver components.

The choice of wavelength depends on two somewhat conflicting factors. We have learned that surface coverage improves with decreasing

wavelength. On the other hand, if the wavelength is too short—1.25 cm, for instance—atmospheric absorption may be serious. Consequently, it is better to operate on 3.2 cm, the shortest wavelength at which components are now fully engineered and which is not seriously affected by atmospheric attenuation. If engineered components were available, however, a wavelength of 2 cm would probably be preferable.

The basic considerations of receiver design have been mentioned in earlier chapters of the book. They lead to the conclusion that to take advantage of the short pulse length selected for the transmitter a band-

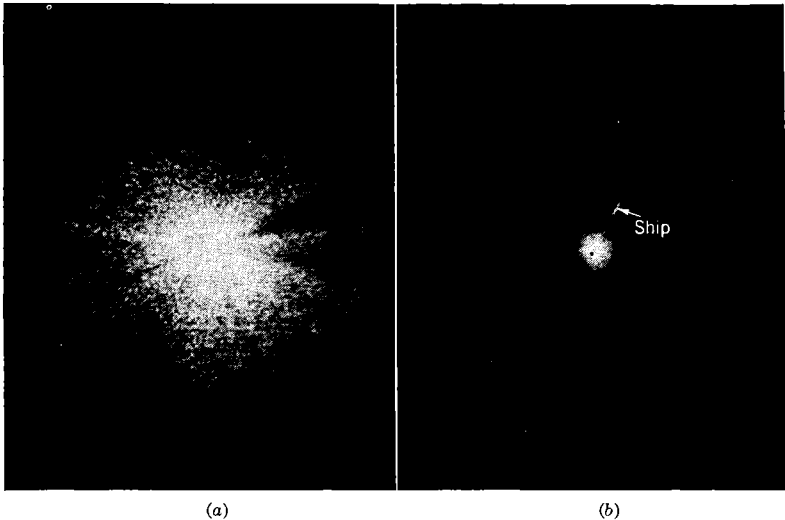

FIG. 10-8.—Comparative photographs showing removal of sea clutter by sensitivity time control. A ship 500 yd away is clearly visible (at 1 o'clock) in (b).

width of 6 to 8 Mc/sec must be used, with a comparable bandwidth for the video amplifier of the receiver. The receiver design is of little concern to the operator, if the engineering of the receiver has been well done. Two factors are, however, very important in the operation of a shipborne navigational radar and are therefore given special emphasis here. First, in order to detect signals, such as docks, at very close ranges the receiver must recover quickly—in a fraction of a microsecond—from any initial paralysis resulting from the leakage of a relatively minute part of the transmitted pulse into the receiver. Secondly, there must be no sea return to mask near-by signals. At close ranges the signal return from sea clutter may be strong enough to saturate the receiver. As a result, the many sea-clutter signals may form a solid mat over the central portion of the PPI and completely mask the signals from other targets, even

fairly large ones. The design characteristics which determine the resolution for ordinary targets (short pulse length, narrow beamwidth, and fast indicator sweeps) help eliminate sea clutter, but a sensitivity time-control (STC, see Sec. 1-2) circuit is more effective than any of these.

Two PPI photographs are presented in Fig. 10-8. The first shows sea-clutter signals that appear with a "normal receiver," that is, a receiver with constant gain. The two V-shaped indentations in the signals were caused by shadows from a near-by mast and funnel. The signal from a ship only 500 yd away, indicated by an arrow, is completely masked by sea clutter. The second photograph, taken less than a minute later, shows the great reduction in sea clutter when an STC circuit is used.

These photographs cover a circle only a little more than 2 miles in diameter. The sea conditions at the time the photographs were taken were such that no appreciable sea-clutter signals were visible beyond a range of about $1\frac{1}{2}$ miles. The STC circuit was adjusted so that beyond that range there was no difference in the appearance of the PPI with or without STC in operation.

10-5. Indicator.—The superior accuracy of the M-M PPI for map-matching techniques was cited in the previous chapter. Such PPI's were built and put into service very early in the development of microwave radars, and have been installed in the great majority of all shipborne radars. The M-E PPI, which has the very marked advantage of containing no mechanically moving parts that require precision gears and bearings, was not acceptable at that early date. The M-M PPI system lends itself very readily to north stabilization, to the use of remote indicators, and to other applications that make use of the existing systems of synchro-transmitted positional data.

Radar indicators usually follow one of the two basic mechanical designs shown in Figs. 10-9 and 10-10. The operating plan for the radar determines which should be used. In the Navy, at least one operator was assigned full-time to each radar. He was provided, almost without exception, with a console or table-type indicator. Navy remote indicators were usually deck-mounted and placed at various stations on the ship for the convenience of men and officers with related duties who could not spend full time at any one station. They could obtain information from any of these indicators with a minimum of effort and confusion.

Probably only the largest commercial ships will have full-time radar operators. The indicator will probably be mounted on the bridge where it will be readily accessible to those concerned with navigation and pilotage. For this purpose a deck-mount indicator with a horizontal tube face is preferable.

The size of the indicator tube depends primarily on the type of cabinet selected and on the way in which the indicator will be used. Three

tube sizes are currently available, 5, 7, and 12 in. in diameter. Since the internal construction of these tubes is very similar, they are really scaled models of the same design. The spot diameter (Sec. 1-6) increases in almost direct proportion to the tube size, with the result that the same amount of detail and the same resolution may be obtained with any of

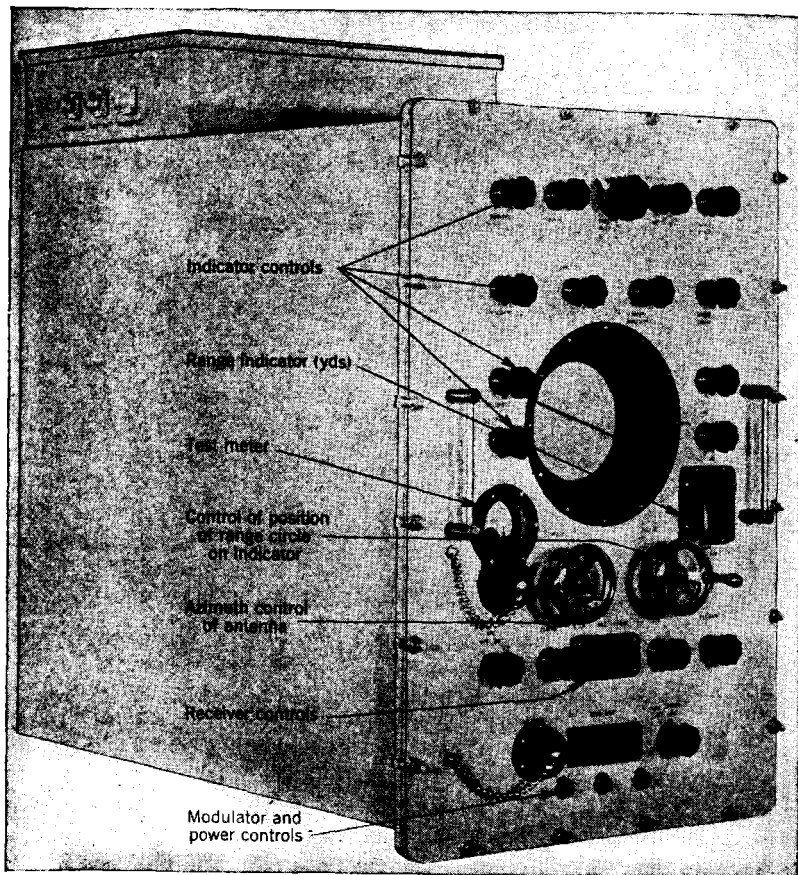

FIG. 10-9.—Shipborne indicator and control panel. Table type of mounting.

the tubes. Although the face of a 12-in. tube is more "out-of-plane" at the edges, its central 7-in. portion is flatter than the entire face of a 7-in. tube. Thus, other things being equal, a 2-mile sweep on a 12-in. tube is preferable to a 1-mile sweep on a 5- or 7-in. tube. The desirable tube size is also determined by the number of persons who might have

occasion to look at the indicator at the same time. For a single operator seated at a table model, a 7-in. tube is sufficient. A 12-in. tube is preferable for a deck-mount indicator to be used by three or four persons simultaneously, or if the tube face is to serve as a plotting surface.

The indicator should provide several sweeps. A 2-mile sweep on a 12-in. tube (or a 1-mile sweep on a 7-in. tube) permits the definition and

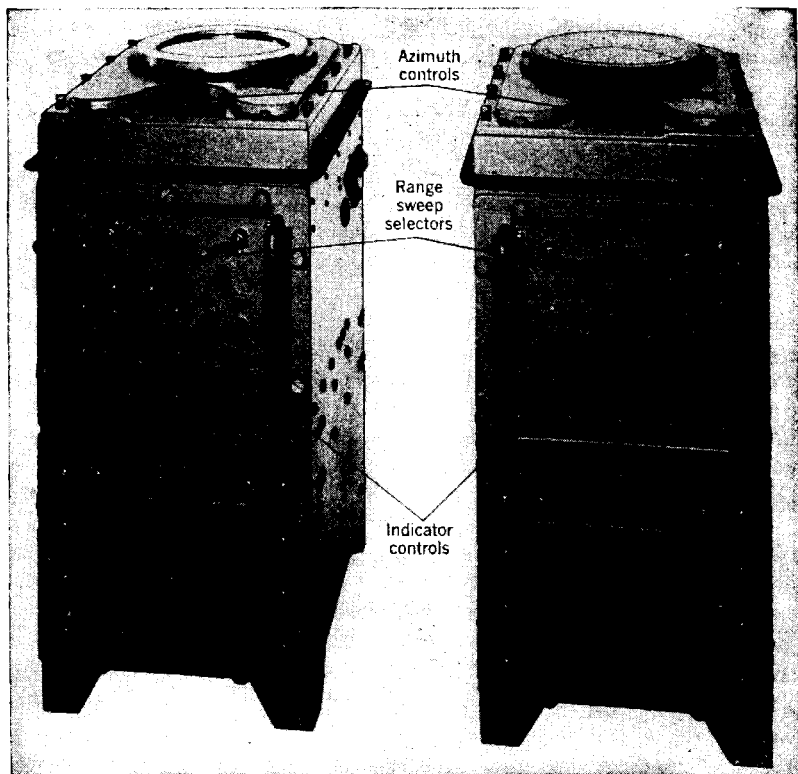

FIG. 10-10.—Shipborne indicator. Deck type of mounting.

resolution adequate to take advantage of the short transmitter pulse length and narrow antenna beam pattern for navigating in close waters. A 10-mile sweep would provide coverage out to the normal radar horizon for antenna heights up to about 75 ft, and would be particularly useful in large bays, outer harbors, or in other areas where a ship may safely proceed at only slightly reduced speed and a careful watch must be kept on many relatively near-by objects. A 20-mile sweep would be most useful for coastal and ocean navigation, and a 40-mile sweep would prove

useful for making a landfall either of a high land mass or a high beacon installation.

The shipborne radar should have a movable range mark on the PPI with the attendant circuits, mechanical gears, and a counter or dial mechanism to indicate the position of the movable marker in yards. Four or five fixed range marks on each sweep allow accurate estimates to be made to a fifth or even a tenth of the distance between range marks. Thus, on the 2-mile sweep the four fixed range marks would subdivide the indicator into 1000-yd units and a target signal could be located by a visual estimate within one of these divisions with an accuracy of better than 200 yd. At the other extreme, the 40-mile sweep would be subdivided into 10-mile divisions and a visual estimate would be no better than 1 mile. The fixed range marks should have an accuracy of 1 per cent or better. The essential parts of the range-mark oscillator should be well designed and packaged in a plug-in unit that can be replaced easily should it become defective.

Since almost all large ships will be equipped with some type of gyro-compass in addition to a magnetic compass, directional data will be available for north-stabilizing the PPI. This great convenience is definitely worth the additional cost of the converter that may be needed to change the electrical output of the compass to a form readily assimilated by the radar. A switch on the indicator will provide means of converting the PPI to relative-bearing operation should the compass data fail or not be available.

It was mentioned previously in Sec. 7-13 that a radar is an excellent device for measuring ranges but is inferior to most optical methods for determining angular positions because of the relatively large beamwidths required. Some of the radar azimuthal errors, however, are of an instrumental nature and arise either in the linkage between the antenna and indicator or in the indicator itself. It has already been seen that a good servomechanism system may link the antenna and indicator with errors substantially less than 1° .

Nearly all shipborne radars measure bearings by the use of a graduated ring around the edge of the PPI tube. A mechanical cursor of some sort is added frequently to eliminate parallax errors introduced by the appreciable distance between the graduated ring and the sensitive surface of the indicator tube. The center of the graduated ring and the center of the cursor must coincide with the center of rotation of the electro-optical elements of the PPI tube or errors in bearing will result. Electronic angle markers go through the same shifts as the target signals and are, therefore, not susceptible to such errors. Such markers are, of course, absolutely essential for off-center PPI's but do not seem necessary for the radar discussed here. Off-center PPI's may be useful for mag-

nifying a distant cluster of signals, but are not so free from distortion as centered PPI's.

Operating Controls.—Because the indicator may be the operating center for the entire radar, most of the controls should be installed in the indicator panel, along with a small meter and a selector switch by means of which the operator may quickly monitor most of the important voltages required for the operation of the several components. The controls mounted on the indicator panel should be kept to a minimum, however, to avoid confusion and "over-manipulation" of the radar. For a simple navigational radar the following controls seem desirable:

1. On-off switch for main power.
2. On-off antenna rotation switch.
3. Receiver (i-f) gain control.
4. PPI range selector switch.
5. Presentation selection switch: radar signals only, beacon signals only, or both simultaneously.
6. Beacon receiver (i-f) gain control.
7. On-off switch for the high-voltage transmitter.

A secondary group of controls requiring only occasional adjustment should be placed beneath a hinged cover, but still in a position accessible to a person observing the indicator.

1. Monitoring meter selector switch.
2. Manual receiver-tuning and AFC on-off switches.
3. Manual beacon-receiver tuning and AFC on-off switches.
4. On-off switch for head marker of ship.
5. PPI focus.
6. PPI dial light control.
7. Relative-true bearing selector-switch.

A few other controls may be necessary to take care of production tolerances in replaceable parts. Because these controls would be adjusted only when a part is replaced or when it is necessary to compensate, after a long period of operation, for aging and change in operational characteristics, they should be located inside the component as near as possible to the associated parts.

10-6. Power Supply.—The primary power supply on the ship may be either direct or alternating current. The voltage at which direct current is used is not great enough to meet the requirements of the electronic circuits. If direct current is used, therefore, a special converter must be supplied. If a-c power is used, however, the radar may be able to use it directly. In general, however, the ship will have the wrong voltage or

a polyphase supply. Transformers or converters are necessary, therefore, for shipborne radars.

The converter output for the radar, furthermore, is usually unstable in both voltage and frequency because the primary power supplies are traditionally unstable. If the radar is designed to operate on a supply with a nominal rating, for example, of 115 volts and 60 cps, the components must be designed to operate satisfactorily with variations in voltage between 105 and 125 volts and variations in frequency between 55 and 65 cps. The navigational radar discussed in this chapter should be made to operate on single-phase, 115-volt, 60-cycle power; probably less than 1 kw of power would be required.

The power-supply component of the radar is actually a collection of transformers, rectifiers (perhaps both dry-disk and electronic-tube types), voltage regulators, and filters, which together supply the special voltages required by the various other radar components.

It is usually impossible to use the same rectifier units on several independent circuits. For example, the modulator requires a high voltage to drive the transmitting tube; the indicator tubes also require relatively high voltages, but they must be free of transient voltages caused by the modulator. Similarly, the receivers require voltages that are free of any disturbances from the indicator sweep circuits. The supplies to the various components may all be fused in the power-supply package, which then also serves as a junction and distribution box. The fuses should be provided with blow-out indicators and the cables should terminate on simple strips. Since the installation is permanent in the same sense as any other wiring on the ship, it is desirable that the wires be soldered in position. If this is not feasible, they should be securely fastened with an individual screw or clamp for each wire. None of the many types of available cable connectors is entirely satisfactory. They should not be used except for very special applications—for example, in an installation that includes pulse transformers between the modulator and the transmitting tube, it is necessary to terminate the interconnecting high-voltage cable with a special type of coaxial connector.

In tropical areas equipment is subject to the attack of fungi and other tropical microorganisms. Except for quantitative differences, the radar components that are mounted at protected interior stations are susceptible to deterioration to the same degree as other electronic equipment such as communication radio transmitters and receivers. Frequently, however, one or more of the radar components are mounted in the open; these call for special design. The antenna, mounted at a high, relatively inaccessible position, is a complex mechanical device that often includes several electrical components, each of which must be completely sealed.

In the past, small electronic equipment was usually shock-mounted in

such a way as to attenuate most of the higher frequency vibrations. Similar shock mounts proved inadequate during the war for the larger and heavier components. This problem should not be difficult to solve when only peacetime applications are involved.

Experience has taught that an attempt to seal a unit and to desiccate its interior with silica gel or some other drying agent is usually less satisfactory than the simpler procedure of permitting the unit to "breathe" and keeping its temperature slightly above ambient. During the war, the Navy kept all radars on "stand by" when not in actual operation; enough heat was dissipated by the vacuum-tube filaments and resistors to keep the components warm. It has been recommended that future marine radar components be equipped with independent heater elements mounted with suitable relays or switches so that the heaters will be energized automatically by the primary power of the ship whenever the radar is turned off.

The r-f components for modern microwave radars are usually of the waveguide type. Although all connections, rotary joints, and terminations are often sealed, as are the pressurized types used with airborne radars, it is best to allow them to breathe, and if necessary, to provide a drain in the form of one or more small holes located at the low point of each section.

10-7. Physical Characteristics of the Components and Test Equipment.—Estimates of the dimensions, weights, and power requirements of the components of a shipborne radar are shown in Table 10-4. These estimates are conservative and probably are larger than the figures for actual equipment.

TABLE 10-4.—ESTIMATED DIMENSIONS, WEIGHTS, AND POWER REQUIREMENTS OF THE RADAR COMPONENTS

	Dimensions, in.,			Weight, lb	Power, watts
	L	W	H		
Antenna.....	60	24	24	125	150
Rf package.....	40	18	18	175	100
Indicator*.....	24	15	45	225	250
Power supply.....	12	12	30	200	200

* The values given are for a deck-mount indicator; a table type might be 2 ft less in height and 25 to 50 lb lighter.

The Navy made a careful survey of the performance of its surface-search radar systems in 1944. When it was found that a large number of them were capable of picking up targets at only half the expected free-space range, "echo boxes," together with carefully written instruction

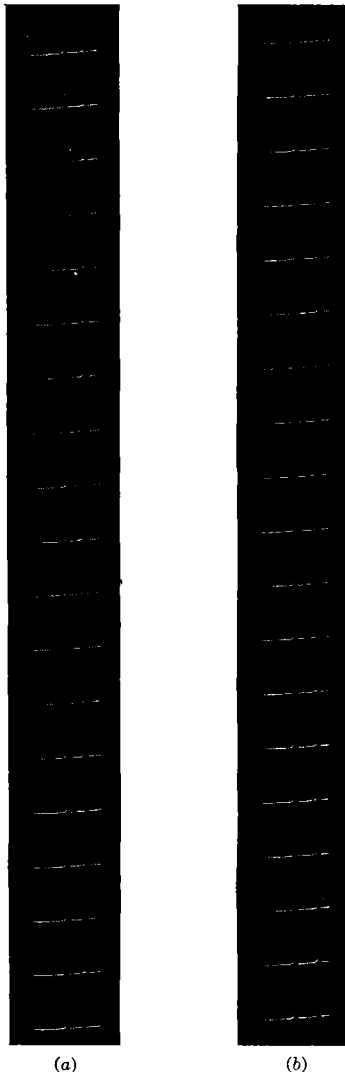

FIG. 10-11.—A series of photographs of an A-scope taken at 16 frames per second showing (a) the rapid variation in the strength of a signal from a typical ship and (b) the relatively steady signal from the periscope of a submerged submarine. In both (a) and (b) the signal on the left was produced by a signal generator at the radar.

manuals were hurriedly distributed to the fleet. The strength of the signals received from other ships usually varies rapidly. This condition precludes their use as satisfactory standards of reference. Such rapid variations (Fig. 10-11) are caused by the rolling and pitching of the target.

An "echo box," shown in Fig. 10-12, is a device for feeding back pseudo-standard signals to the receiver. After a small part of the primary pulse is fed into an echo box, the box will "ring" for many microseconds while it slowly feeds energy back into the radar receiver. This energy will appear on the radar indicator as a long continuous signal that starts at zero range and extends out a few thousand yards. Figure 10-13 shows the diagram of an echo-box signal on both an A-scope and a PPI. The exact range at which the echo-box signal becomes so small that it disappears into the normal receiver noise varies with each operator.

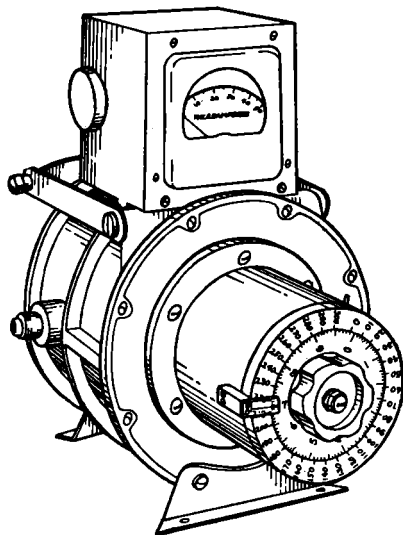

FIG. 10-12.—An echo box. (Courtesy of Johnson Service Company, Milwaukee.)

Most people find it a little easier to make the measurement on the A-scope. With a little practice one may obtain equally good results on a PPI. The important thing is that the operator must be able to make consistent measurements. The range at which the signal disappears is in a sense indicative of the over-all performance of the system; the greater the range, the better the performance. The echo boxes, used with the Navy practice of a careful check by experienced personnel whenever the ship was in port, were found to improve the radar performance considerably.

A radar system requires several times as much equipment as an ordinary radio and, consequently, must be very carefully engineered. Many otherwise difficult tests can be made routine, however, if the designer incorporates simple devices for testing the various components into the system. These provisions, a few simple pieces of external test

equipment, and a carefully written instruction manual in the hands of a normally intelligent man, go a long way toward solving the maintenance problem at sea.

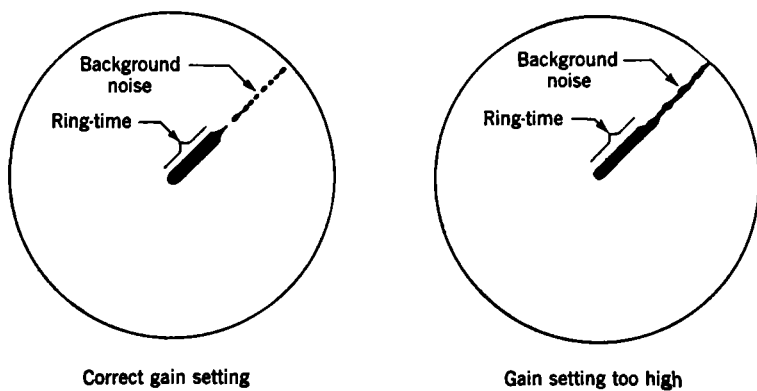
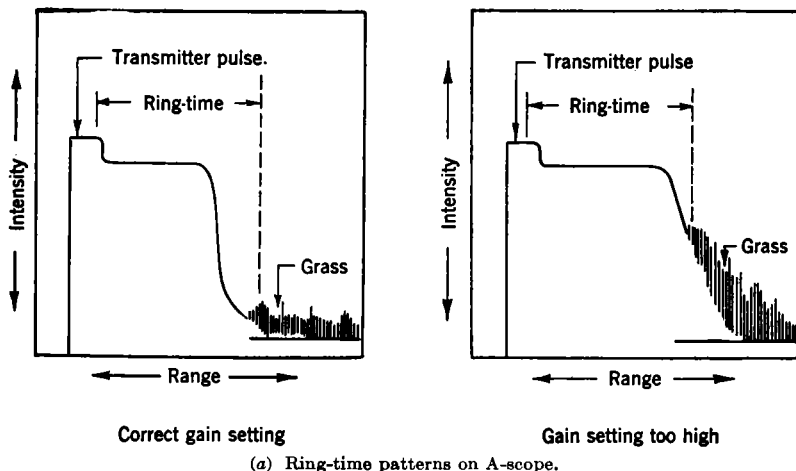

FIG. 10-13.—Signals from an echo box.

A wartime visitor noticed this maxim hung over the workbench in a radar maintenance shack on a tropical island in the Pacific: "If the tubes light and the voltages are right, the damn thing will work." It is difficult to think of a set for which this statement, broadly interpreted, would not be true.

Index

A

ADF, 46
 advantages of, 53
 limitations of, 53
 use of, 53
Aero Service Corporation, 32
AFC, 143
Airplane detection over water, 115
Altimeter, frequency-modulated, 136-141
 pulsed, and f-m, comparison of, 141
 radio, 131-142
 pulsed, 132-136
Altitude determination, 131-142
American Machine and Foundry Company, 222
Amplidynes, 28
Amplifier, intermediate-frequency, 10
 video, 10
AN/APN-1, 136-141
AN/APQ-7, 187
AN/APQ-13, 187
AN/APS-3, 186
AN/APS-10, 171-185
 beacon response of, 175
 components of, 180
 coverage diagram of, 176
 future trends of, 185
 performance of, 173
 technical characteristics of, 182
AN/APS-15, 186
AN/MPN-1 (*see* GCA)
Antenna, 5
 microwave radar, 194
Antenna assembly of shipborne navigational radar, 364
Antenna gain (*see* Gain, antenna)
Antenna size, beamwidth, and wavelength, relation between, 14
Antenna stabilization (*see* Stabilization, antenna)
Antennas, 155
 airborne, 155

Antennas, search and height-finding, on single mount, 221
 shipborne, 367-370
Anticlutler circuits, advantages of, illustration of, 197
 effects of, 114
Anticollision devices, for use over land, 129
 for use over water, 129
Anticollision radar devices, 128-131
AN/TPS-10, 219-227
AN/TPS-10 mount, 215
AN/TPS-10 presentation, 217
AN/TPS-10 range-height indicator, 216
Approach, final, control in, 306-310
 instrument, standard, 291
Approach system, beam, 227-232
 beacon (*see* BABS)
 GCA (*see* GCA)
ARP (*see* Radar projector, autofocus)
ASB-3, 186
A-scope, 30
A-scope presentation, 31
Aslakson, Lt. Col. Carl, 282
Attenuation, atmospheric, 22
 by nitrogen, 22
 by oxygen, 22
 by precipitation, 22
 by water vapor, 25
Automatic frequency control (*see* AFC)
Ayres, R. C., 187
Azimuth accuracy, 12
Azimuth error, radar, 367
Azimuth markers, 148
Azimuth resolution, 12
 and beamwidth of antenna, 14
Azimuth stabilization, aircraft, 149
 ships, 367-371

B

BABS, 232-237
BABS airborne reception and indication, 234

- BABS ground responder beacons, 233
- BABS interrogation, 233
- BABS L-scope localizer presentation, 234
- BABS system, American 200-Mc, L-scope presentation of, 235
- British, recent, indicator for, 235
- Baltzer, O. J., 358
- Bats, 3
- Beacon, airborne, 256-258
- maximum and minimum range with, 257
- application of, 37
- coding of, (*see* Coding)
- future developments of, 40
- ground, cost of, 189
- ground based, special applications of, 121
- interrogation of, 36
- marine design, 323
- marine radar, 322-324
- location of, 322
- operational use of, 322
- omnidirectional, 51
- radar, 36-43
- block diagram of, 38
- separate-band, 42
- special provisions for, in radar, 40
- Beacon equipment, 39
- Beacon navigation, radar, 117-121
- Beacon systems, 42
- radar, 257
- Beacon transmitter, 36
- Beacon transmitter frequency, 40
- Beam, antenna, 5
- Beamwidth, antenna, 12
- and azimuth resolution, 14
- antenna size, and wavelength, relation between, 14
- resolution with different, photographs showing, 365
- Bearing, measurement of, 9
- Bearing transmission circuit for ship navigation radar, 34
- Beavertail, 210
- Beavertail systems, 215-223
- Bendix Aviation Corporation, 247
- Blind-landing system, bolometer, 228
- Boundaries, land-water, 90
- British Air Ministry, 73
- B-scope, 35
- C
- Cathode-ray tubes, 26
- Chart matching, 335 (*See also* Navigation, ship, superposition)
- accuracy obtainable by, 344
- indicator requirements for, 350
- Chart-matching devices, suggested improvements for, 351
- Chart-matching equipment, 335
- Cities, general features of, 91-96
- Civil Aeronautics Administration, 287
- Coding of beacons, 40
- frequency, 41
- pulse-width, 41
- range, 36
- space, 41
- Cold front, radar echoes from, 320
- Compass, airborne radio, advantages of, 53
- disadvantages of, 53
- radio, 46
- Corner reflectors, 324
- clusters of, 326, 328
- dropped from airplane, 112
- 4-ft, 330
- mounted on life raft, 329
- square, 325
- triangular, 325
- Cosecant-squared coverage (*see* Coverage, cosecant-squared)
- Counter, V. A., 358
- Course indication, 117
- Course indicator method of navigation, 119
- Coverage, 14
- cosecant-squared, 15
- Coverage diagram, of GCA antennas, 242
- of long-range microwave radar system, 202
- Cowan, E. W., 113
- Cross-sectional area, effective, 16
- Cruft Laboratory, 49
- Curvature of earth, 21
- D
- Decca, 76
- Dipole, 16
- Direction finders, airborne, 51-54
- automatic (*see* ADF)

Direction finders, ground, 54
 shipborne, 51-54
 Distortion, associated with resolving
 power, 91
 due to finite beamwidth and pulse
 length, 153
 range, on PPI, 151
 Doppler frequency shift, 107
 Doppler method, possibility of ground-
 speed determination by, 110
 Drift, measurement of, 105-110
 over water, determination of, 110
 Drift determination, doppler, 107
 Durkee, A. L., 263

E

Echo box, 381
 Errors, deck-tilt, 364

F

Fairbank, W. M., 358
 Filter room, 200
 Fixes, taking with beacons, 117
 Flight rules, contact, CFR, 288
 instrument, IFR, 288
 Flights, over water, information avail-
 able on, 112-115
 Fyler, G. W., 31, 320

G

Gain, antenna, 16
 Galambos, R., 3
 Gating system, block diagram of, 205
 GCA, 227, 237-251
 advantages and limitations of, 248-
 251
 antenna beam coverages of, 242
 near Verdun, France, 238
 PPI of, 241
 GCA azimuth and elevation assemblies,
 244
 GCA operations, trailer, interior of, 240
 GCA presentation, 241, 245-247, 249
 Gee, 60-64
 homing with, 63
 limitations of, 63
 Gee coverage, in United Kingdom, 61
 Gee system indication, 62
 General Electric Company, 29, 31, 320
 Gilbert, G. A., 287
 Glide-path system, 227

Gordy, W. O., 358
 Goudsmit, S. A., 69
 GPI, 122-128
 Griffin, D. R., 3
 Ground-based scanning radar systems,
 237-251
 Ground control of approach (*see* GCA)
 Ground-position indicator (*see* GPI)
 Ground speed, measurement of, 105-110
 over water, determination of, 110
 Ground-speed determination, instantane-
 ous, possibility of, by doppler
 method, 110

H

Hansell, C. W., 260, 262
 Height finders, 207-227
 beavertail, 10-cm, mount of, 218
 Height finding, accuracy of, absolute and
 relative, 212
 effect of elevation beamwidth on,
 213
 methods of, 207
 long-wave, 208
 pencil beam with conical scan, 210
 V-beam, 211
 vertically scanned beams, 210
 Hexem, J., 274
 Hight, S. C., 263
 Hollingsworth, L. M., 261, 265
 Homing with Gee, 63
 Horn antenna feed, 15, 16
 Hudspeth, E. L., 328, 358
 Hyperbolic navigation, principle of, 57
 Hyperbolic systems, accuracy of, 77
 automatic piloting by, 82-85
 of navigation, 56-60
 positional accuracy of, 59
 range of, 77

I

IFF system, 42
 Indicator, 7, 26-36
 design considerations for, 148-155
 plan position (*see* PPI)
 presenting search and height data, 223
 for shipborne navigational radar, 373-
 377
 types of, 30-36
 (*See also* specific types of indicators)

- Interrogator-responder, 42
 Ionosphere, reflections from, 71
- J
- James, H. M., 264, 366
- L
- Landfall, 112
 Landing, final, control in, 306-310
 radar aids for, 227-251
 Landing aids (see Approach system)
 Landing system, bolometer, 228
 Lawson, A. W., Jr., 261, 265
 LF Loran (see Loran, LF)
 Life of single pulse, 8
 Lobe region, 356
 Lobes, side, 13
 Localizer system, 227
 Logemann, H., Jr., 261
 Loran, 64-70
 automatic data analysis of, 79-82
 average errors of fix for, 66
 disadvantages of, 70
 LF, 72-76
 average position-line error, 74
 indication, 75
 SS, 70-73
 chart, 73
 quadrilateral, 72
 Loran coverage, New York to Bermuda, 69
 Loran indicators, 67
 Loran plotting-board chart with Loran
 projection, 81
 Loran station on Faroe Islands, 68
 Loran system indication, 65
 Lorbumb line, 84, 85
 Low-frequency Loran (see Loran, LF)
 L-scope localizer presentation, 234
 L-scope presentation of American 200-Mc
 BABS system, 235
- Mc
- McLaughlin, D. B., 353
- M
- μ sec, 4
 Map, radar, 346-359
 of Boston, Mass., 97, 99
 of Chicago, Ill., 100
 of Detroit, Mich., 100
 of New York, N. Y., 98
 of northeastern U. S. A., 90
- Mapping, radar, details in, 96
 built-up areas, 96-101
 mountain relief, 103
 returns from highways and run-
 ways, 101, 102
 features revealed by, 89-96
 radar aids to, 278-284
 Maps, use of, as aids to radar pilotage, 115
 Markers (see Azimuth, Height, Range
 markers)
 Martin, E. G., 331
 Matching techniques, 333
 Measurements, short-range, 279
 Microsecond, μ sec, 4
 Microwaves, definition of, 21
 Miller, E. E., 353
 Modulator, 5
 Morgan, H. K., 187
 Moving target indication (see MTI)
 MTI, 252-256
 airborne, 255
 block diagram of radar set with, 252
 delay line for use with, 253
 performance of, 253
 shipborne, 255
 MTI response curves for 10-cm operation,
 255
 Myers, W. L., 166
- N
- Nash, J. P., 328
 National Advisory Committee for Avia-
 tion, 158
 Navigation, air, and traffic control, 285-313
 available radar aids for, 293
 limitations of present system, 291
 special equipment for, 302
 statement of problem of, 285-287
 summary of proposed radar aids
 for, 311-313
 using airborne radar aids, 293-299
 using ground-based radar aids,
 299-310
 (See also Traffic control)
 celestial, 55
 hyperbolic systems of (see Hyperbolic
 systems of navigation)
 radar beacon, 117-121
 ship, and pilotage, 317-353
 how radar can help in, 317-320

Navigation, ship, superposition, 331
 bibliography of literature on, 353
 principle of, 331-335
 (*See also* Chart matching)
 Navigation methods, nonradar, 44-85
 Navigation radar, ship, bearing transmission circuit for, 34
 Navigational aids, ultrahigh-frequency, 50
 Navigational microfilm projector, 338
 Navigational nets, 56-85
 NMP (*see* Navigational microfilm projector)
 Noise, 16
 Noise power, background, of receiving system, 19

O

Operating controls of shipborne navigational radar, 377
 Operator, radar, 105
 Oscilloscope, 26

P

Paraboloids, 14
 Paracourse lines, 119
 Pass band, 10
 PGP, 228-232
 cross-pointer meter for, 230
 evaluation of, 231
 Piloting, automatic, by hyperbolic systems, 82-85
 Plan position indicator (*see* PPI)
 Plotting board, example of, 201
 Polarization and sea return, 113
 Position, identification of, by group of signals, 93
 by shape of built-up areas, 94
 Power, pulse, of transmitter, 15
 Power supply of shipborne navigational radar, 377-379
 PPI, 5, 30-35
 on D-day, 203
 of GCA, 241
 of high-resolution shipborne radar, 318
 Magnetic-Electric (ME), 34
 Magnetic-Mechanical (MM), 34
 Magnetic-Selsyn (MS), 34
 off-center, 199

PPI, range distortion on, 151
 resolved current type, 34
 resolved voltage type, 34
 rotating coil, 34
 typhoon on, 321
 PPI circuit, 33
 PPI pattern superimposed on map, 337
 PPI photograph taken from ship in Boston Harbor, 319, 365
 PPI presentation of northeastern United States, 90
 PPI reflectoscope, virtual, 336
 PPI simulations, 351
 Precipitation, attenuation by, 22
 PRF, (*see* Repetition rates)
 Propagation, 21-26
 anomalous, effects of, 220
 nonstandard, 360-363
 of radar waves, over water, 354-363
 Pulse, single, life of, 8
 Pulse length, 19
 Pulse repetition frequency (*see* Repetition rates)
 Pulsed glide path (*see* PGP)

R

Radar, airborne, characteristics of, 89-121
 design considerations, 165-171
 economic aspects of, 187
 electrical noise interference and its elimination, 169
 performance of AN/APS-10, 171-185
 performance of some existing systems, 185
 primary electrical power for, 169
 radome problems, 161-165
 scanner installation, 161-165
 test equipment, 170
 fundamental ideas of, 3-10
 ground-based, 193-227
 Handy, 280
 principles of, 3-43
 shipborne navigational, antenna assembly of, 364-371
 general specifications for, 363
 indicator for, 373-377
 physical characteristics of components of, 379
 specifications for, 363-382

- Radar, shipborne navigational test equipment for, 379-383
 transmitter-receiver package for, 371-373
 sonic analogy to, 4
- Radar aids, to air navigation (*see* Navigation, air; Traffic control)
 for landing, 227-251
 to mapping, 278-284
 to navigation of ships (*see* Navigation, ship)
 to traffic control (*see* Navigation, air; Traffic control)
- Radar antenna (*see* Antenna, radar)
- Radar beacons (*see* Beacons, radar)
- Radar chart projector, 341
- Radar design, for use with marine beacons, 323
- Radar earth, 22
- Radar map (*see* Map, radar)
- Radar mapping (*see* Mapping, radar)
- Radar pilotage, use of maps as aids to, 115
- Radar-pilotage maps, 115
- Radar projector, autofocus, 340
- Radar pulses, 4
- Radar relay, 258-267
 amplitude modulation, 264
 choice of frequency for, 261-263
 comparative photographs of, 266
 frequency modulation, 264
 general design problem of, 260
 intermediate stations for, 264
 minimum usable signal, 260
 multichannel transmission, 264
 summary of, 265
 synchronization of, 265
- Radar relay link, type-A, 258
 type-B, 259
- Radar systems, for airway and airport control, proposed rough specifications of, 301
 automatic tracking, 202-207
 microwave, long-range, 193-202
 coverage diagram of, 202
 range of, 196
- Radiator, isotropic, 17
- Radio altimeters (*see* Altimeters, radio)
- Radio Corporation of America, 132, 136
- Radio range, 44-47
 German, 47-50
 single, navigation by means of, 45
 uhf, 50
 visual two-course, 50
- Radio-range navigation, advantages of, 46
 aids to, 46
 limitations of, 46
- Radome problems, 161-165
- Range, measurement of, 5
 minimum, 10
 radio, (*see* Radio range)
 slant, 151
- Range equation, 15-18
- Range-height indicator (*see* RHI)
- Range markers, 148
- Range resolution, 10, 14
 importance of, 150
- Rapid scan system, 187
- RCP (*see* Radar chart projector)
- Receiver, 7
 design consideration, 143-148
 recognition of indicator patterns, 331
- Refraction, atmospheric, 21
 standard, 22
- Relay radar (*see* Radar relay)
- Repetition rate, 16, 18
- Reproduction of canned data, 268
- Resolution, with different beamwidth, photograph showing, 365
 range, importance of, 150
- Resolving power, distortion associated with, 91
- RHI, 36, 210
 RHI presentation, 217
 of 10-cm height finder, 219
- Robinson scanner, 222

S

- Samson, E. W., 265
- Sandretto, P. C., 45, 50, 52, 54
- Scan system, rapid, 187
- Scanner, Robinson, 222
- Scanner installation, 161-165
- Scanning, types of for airborne systems, 155
- Scanning loss, 19, 214
- Scanning rate, 155, 214

- Scanning techniques, for automatic tracking, 203
- Scattering, 22
- SCR-718C, 132-136
- Sea clutter, removal of, by sensitivity time control, 372
- Sea return, and its alleviation, 112-115 and polarization, 113
- Searchlighting, 19
- Sensitivity time control, 11, 13, 146 removal of sea clutter by, 372
- Servomechanism 9, 28
- Ship detection, by airborne radar, 112
- Shoran, 281-284 accuracy obtainable by, 284
- Shoran equipment, airborne station, 282
- Shoran ground station, 281-283
- Signal, minimum discernible, 16, 20
- Sinsheimer, R. L., 185
- Smith, C. A., 353
- Sonic analogy to radar, 4
- Sonne, 47-50
- Spencer, R. C., 327
- Sperry Gyroscope Company, 230
- Squint angle, 204
- SS Loran (*see* Loran, SS)
- Stabilization, airborne antenna, 156-160 azimuth, 149 methods of, 159 roll, 160 of shipborne navigational radar, 367-371
- Stabilization requirements, airborne radar, 158
- Storm detection, 104
- Sturtevant, J. M., 261, 265
- Surface region, 357-360
- Surface vessel detection, 112
- Sweep, 7
- Synchronizer, 5
- Synchros, 28
- T
- Temporal gain control, 11
- Three-tone provisions, for PPI 144
- Time-varied gain, 11, 146
- Traffic control, in approach zones, 304 by ground radar, advantages and limitations of, 310
- Traffic-control system, present, 287-293
- Transmitter, 5
- Transmitter-receiver package, 371-373
- Transponder, 36
- Trigger, 5
- Typhoon, on PPI, 321
- U
- United States Army, 133, 216, 217, 233, 244
- United States Army Air Force, 282, 283
- V
- V-beam, 211
- V-beam control room, 226
- V-beam mount, 224
- V-beam presentation, 225
- Video, 7
- Video mapping, 267-278 applications of, 270 to GCA, 272 delineation of flight paths by, 271 equipment for, 275 general principles of, 267 precision of, 273 reproduction by different methods, examples of, 276-277 reproduction of "canned" data by, 268 reproduction of live data by, 274
- Virtual PPI reflectoscope (*see* PPI reflectoscope, virtual)
- VPR (*see* PPI reflectoscope, virtual)
- W
- Wavelength, 14 beamwidth, and antenna size, relation between, 14 choice of, 20, 195-198, 371

